



PROMODAY
2023

ITALIA € IVA ESCLUSA

PROMODAY 2023

	CHIAVI DI MANOVRA	8
	CHIAVI A BUSSOLA	12
	GIRAVITI E PINZE	20
	ELETTRONICA E ELETTROTECNICA	24
	UTENSILI DINAMOMETRICI	26
	UTENSILI DA TAGLIO	28
	MANUTENZIONE GENERALE	30
	LAMPADE	34
	BORSE DA LAVORO	44
	ESTRATTORI	50
	UTENSILI PNEUMATICI	52
	CARRELLI E BANCHI DA LAVORO	60
	ARREDAMENTO TECNICO	98
	ARREDAMENTO FURGONI	106
	AUTOMOTIVE	110
	PROFESSIONAL EQUIPMENT	130

L'azienda

Identity

Realizziamo strumenti professionali dal 1976

Nata nel 1976, l'azienda lancia nel 2002 il marchio **FASANO TOOLS** che, sin da subito, si pone sul mercato come un brand innovativo ed alternativo nel mondo dell'utensileria professionale.

Nella sede operativa di circa 3.000 mq², situata a Lecce, in Italia, sono concentrate le attività di produzione e logistica.

Oltre 40 anni di esperienza e l'ascolto continuo di fruitori e partner commerciali, hanno consentito all'impresa di crescere e diventare una realtà di riferimento nel settore, consolidare la sua presenza a livello Nazionale e rafforzare quella a livello Internazionale.

I prodotti Fasano Tools sono rivolti ai professionisti dei settori **Industria, Automotive e Artigianato.**

Soggetti a rigorosi controlli qualitativi, gli utensili e i macchinari sono caratterizzati da elevate prestazioni in termini di potenza, grande affidabilità nel tempo, nonché compattezza e maneggevolezza, fondamentali per un utilizzo efficace.





Fasano Tools si differenzia sul mercato per l'ampia gamma di attrezzi da lavoro che copre tutti i settori di riferimento e per la vasta e costante disponibilità dei ricambi. Punti di forza della nostra realtà sono, infatti, l'assistenza e l'attenzione alle certificazioni, volontarie e obbligatorie, alle quali sono sottoposti puntualmente i prodotti, per rispettare, come da norme vigenti, gli standard internazionali.

Supporto fondamentale per l'attività di Fasano Tools è il sito web, straordinariamente ricco di informazioni sui prodotti, schede tecniche dettagliate, manuali, elenco ricambi e strumenti innovativi per trovare l'attrezzo o il kit necessario al proprio lavoro. Come il Tool Finder, rivoluzionario motore di ricerca interno, dedicato alla gamma dei prodotti per fasatura motore.

La comunicazione di Fasano Tools si estende, inoltre, dal web al mondo dei Social media, dove si caratterizza per un'attività mirata e differente per ogni Canale.



Con oltre 40 anni di esperienza, l'azienda ha una **VISION** ben chiara.

Si propone di non perdere mai quello spirito critico verso il mondo e il mercato e, attraverso l'impegno costante e la ricerca di innovazioni a supporto del lavoro, di affrontare con flessibilità le sfide del settore e di anticiparne le evoluzioni. **Oggi come ieri.**

Le NOVITA'

2023

Anche quest'anno miglioriamo la nostra offerta con nuovi prodotti, sempre più efficienti e dedicati a professionisti di settori specifici.

AMPLIAMO LA GAMMA

La ricerca di soluzioni innovative, pratiche e funzionali, ci spinge ogni anno ad estendere la nostra proposta, con un assortimento sempre più vasto e completo. Le nuove pinze sono gli utensili adatti al professionista di oggi, sempre più specializzato.

METTIAMO IN LUCE LE INNOVAZIONI DI SETTORE

Con la luce giusta, tutto può cambiare. Lo sa bene il professionista al quale è rivolta la nostra nuova collezione di lampade, dedicate al settore Carrozzeria. Nella quotidianità del lavoro è necessario che gli strumenti di supporto siano portatili, versatili, ma anche precisi e performanti. Non basta illuminare, a volte bisogna far risplendere!

ALZIAMO GLI STANDARD

Con i nuovi sollevatori, tra i quali i nuovi modelli dal design ribassato, abbiamo alzato anche gli standard ed ora è più facile lavorare, anche su veicoli di portata elevata, come fuoristrada e furgoni. Le nostre nuove proposte presentano un'altezza elevata rispetto alla media di mercato ed il meccanismo di sollevamento senza pedale, assicura più comodità di utilizzo con meno sforzo.



NUOVE PINZE INDUSTRIAL

Nuovi utensili dalle performance elevate arricchiscono l'offerta di pinze Fasano Tools già presente a catalogo. La **NUOVA GAMMA di PINZE INDUSTRIAL** si caratterizza per **comodità d'uso e prestazioni efficaci anche nelle applicazioni più pesanti.**

20+ MODELLI

CAPACITÀ DI TAGLIO FINO A 6mm*

Il dato si riferisce al valore massimo coperto dalla gamma

DUREZZA ACCIAIO **HRC 63**

HIGH LEVERAGE

FACCIAMO LEVA

SU ESIGENZE PROFESSIONALI SPECIFICHE

Nella gamma di PINZE INDUSTRIAL le versioni High Leverage presentano un "ALTO EFFETTO LEVA" che garantisce maggiore comodità durante l'uso ed una significativa riduzione dello sforzo della mano.



+ 25% DI CAPACITÀ DI TAGLIO
- 35% DI SFORZO*

IL FULCRO POSIZIONATO PIÙ VICINO AI TAGLIENTI E PIÙ DISTANTE RISPETTO ALLA POSIZIONE DI IMPUGNATURA

FINITURA LUCIDA

IMPUGNATURA BI-MATERIALE

AUMENTA L'EFFETTO LEVA, RIDUCENDO NOTEVOLMENTE LO SFORZO DURANTE L'UTILIZZO.

* Taglio del filo armonico del modello FG 59/HL200 rispetto al modello FG 59/XT200



SOLLEVATORI IDRAULICI

3 Nuovi modelli

Prestazioni ancora più elevate e sempre meno sforzo. Sì, con i nuovi sollevatori idraulici Fasano Tools!

NUOVO DESIGN RIBASSATO in 2 modelli per lavorare anche su veicoli pesanti o con assetto sportivo.

NUOVO MECCANISMO DI SOLLEVAMENTO SENZA PEDALE che riduce lo sforzo di utilizzo e aumenta la stabilità nel sollevamento.

NUOVO GRUPPO POMPANTE dotato di doppio pistone per facilitare il sollevamento del peso.

ALTEZZA MASSIMA più elevata rispetto agli altri modelli in commercio.



ROBUSTA STRUTTURA IN METALLO



IMPUGNATURA CON GOMMA ANTIURTO



VALVOLA DI SPURGO DELL'ARIA

NUOVE LAMPADE PER CONTROLLO COLORE

La gamma di lampade e faretto Fasano Tools si arricchisce di nuove proposte, ancora più performanti, dedicate al Settore Carrozzeria.

Portatili, rotanti, orientabili e inclinabili, le nostre lampade si adattano agli spazi di manovra ed al tuo lavoro, come non mai!

PIÙ LUCE, PIÙ PRECISIONE

Le più durevoli nel tempo, anche con intemperie e agenti esterni.

Le più resistenti agli urti.

Le più adatte ai lavori da svolgere all'esterno.

Le migliori per restituire una visione realistica del colore, relativo alla verniciatura.

NUOVI PRODOTTI

SETTORE CARROZZERIA

LAMPADE

REGOLABILI NELL' INTENSITÀ
E NELLA TEMPERATURA COLORE

Scoprite tutte nella sezione
**12 MANUTENZIONE
GENERALE**



GRADO DI PROTEZIONE

IP65

GRADO DI RESISTENZA AGLI URTI

IK07

ALTO INDICE DI RESA CROMATICA

CRI 96+

COB LED - cri 96+
3 COLORI

2700K 4500K 6500K





CHIAVI DI MANOVRA



FG 600/ST9

**SET 9 CHIAVI COMBinate
POLIGONALI CON
SUPPORTO IN ABS**

CONTENUTO:
8,10,11,12,13,14,15,17,19 mm

~~95,80€~~ **55,00€**



FG 600/SC17

**SET 17 CHIAVI COMBinate
POLIGONALI IN BOX DI CARTONE**

CONTENUTO:
6, 7, 8, 9, 10, 11, 12, 13, 14,
15, 16, 17, 18, 19, 20, 21, 22 mm

~~175,00€~~ **99,00€**



FG 600/SC16

**SET 16 CHIAVI
COMBinate POLIGONALI**

CONTENUTO:
6,7,8,10,12,13,14,16,
17,19,21,22,24,27,30,32 mm

~~225,80€~~ **129,00€**



FG 600/SC25

**SET 25 CHIAVI COMBinate
POLIGONALI IN BOX DI CARTONE**

CONTENUTO:
6, 7, 8, 9, 10, 11, 12, 13, 14, 15, 16,
17,18, 19, 20, 21, 22, 23, 24, 25, 26, 27,
28, 30,32 mm

~~375,80€~~ **199,00€**

EXTRA PIATTA



FG 602C/SP9

**SET 9 CHIAVI A DOPPIA FORCHETTA
ULTRA PIATTE IN ROTOLO DI NYLON**

CONTENUTO:
6x7,8x9,10x11,12x13,14x15,
16x17,18x19,20x22,21x23mm

~~90,80€~~ **54,00€**



FG 602/SC13

**SET 13 CHIAVI A DOPPIA
FORCHETTA IN BOX DI CARTONE**

CONTENUTO:
6x7, 8x9, 10x11, 12x13, 14x15, 16x17,
18x19, 20x22, 21x23,
24x26, 25x28, 27x29, 30x32 mm

~~140,80€~~ **85,00€**



FG 613/S9

**SET 9 CHIAVI A PIPA ESAGONALI-POLIGONALI
IN BOX DI CARTONE**

CONTENUTO:

8, 10, 11, 12, 13, 15, 17, 18, 19 mm

~~175,00€~~ **105,00€**



FG 180/SP6

~~122,00€~~ **69,00€**

SET 6 CHIAVI PER RACCORDI TUBO IN ROTOLO DI NYLON

CONTENUTO: 8x10, 10x11, 11x13, 12x14, 17x19, 19x22mm

FG 180/SP9

~~212,00€~~ **119,00€**

SET 9 CHIAVI PER RACCORDI TUBO IN ROTOLO DI NYLON

CONTENUTO: 8x10, 9x11, 10x11, 11x13, 12x14, 17x19, 19x22, 24x27, 30x32mm



FG 619H/S6

~~227,00€~~ **135,00€**

**SET 6 CHIAVI A T MASCHIO ESAGONALI
SNODATE IN BOX DI CARTONE**

CONTENUTO: 3, 4, 5, 6, 8, 10 mm



FG 619TX/S8

~~340,00€~~ **199,00€**

**SET 8 CHIAVI A T SNODATE
TORX IN BOX DI CARTONE**

CONTENUTO: TX20, 25, 27, 30, 40, 45, 50, 55



FG 618E/S9

**SET 9 CHIAVI A T SNODATE
TORX IN BOX DI CARTONE**

CONTENUTO: E6, E7, E8, E10, E12, E14, E16, E18, E20

~~410,00€~~ **249,00€**



FG 618/S7B

**SET 7 CHIAVI A T
SNODATE ESAGONALI**

CONTENUTO:

7, 8, 10, 12, 13, 14, 17mm

~~245,00€~~ **149,00€**



FG 618/S7

**SET 7 CHIAVI A T
SNODATE ESAGONALI**

CONTENUTO:

8, 10, 11, 13, 14, 17, 19 mm

~~265,00€~~ **159,00€**



FG 618/S10

**SET 10 CHIAVI A T
SNODATE ESAGONALI**

CONTENUTO:

8, 10, 11, 12, 13, 14,
15, 16, 17, 19 mm

~~385,00€~~ **235,00€**





CHIAVI DI MANOVRA



ASTA SCORREVOLE

FG 621H/S8C

SET 8 CHIAVI A T MASCHIO ESAGONALI CON ASTA SCORREVOLE

~~152,00€~~ 89,00€

CONTENUTO: 2,2.5,3,4,5,6,8,10mm



ASTA SCORREVOLE

FG 621TX/S13

SET 13 CHIAVI A T MASCHIO TORX CON ASTA SCORREVOLE

~~235,00€~~ 129,00€

CONTENUTO: 6,7,8,9,10,15, 20,25,27,30,40, 45,50 TX



CHIAVE POLIGONALE DOPPIA

FG 609A/S5

~~95,00€~~ 55,00€

SET 5 CHIAVI DOPPIE POLIGONALI

CONTENUTO: 10x12, 11x13, 14x17, 16x18, 19x22 mm



CHIAVE DOPPIA DIRITTA TORX

FG 600E/S4

~~52,00€~~ 29,90€

SET 4 CHIAVI DOPPIE DIRITTE TORX

CONTENUTO: E6xE8, E10xE12, E14xE18, E20xE24



FG 615A/S6

SET 6 CHIAVI DOPPIE CON CRICCO REVERSIBILE UNIVERSALE A 90 DENTI

CONTENUTO: 8x9, 10x11, 12x13, 14x15, 16x18, 17x19mm

~~130,00€~~ 75,00€

FG 622A/S6

SET 6 CHIAVI A CRICCO UNIVERSALE SERIE EXTRA-LUNGA

CONTENUTO: 8x9, 10x11, 12x13, 14x15, 16x18, 17x19 mm

~~130,00€~~ 79,00€

FG 622A/S2

SET 2 CHIAVI A CRICCO UNIVERSALE SERIE EXTRA-LUNGA

CONTENUTO: 21x22, 24x27 mm

~~80,00€~~ 49,00€

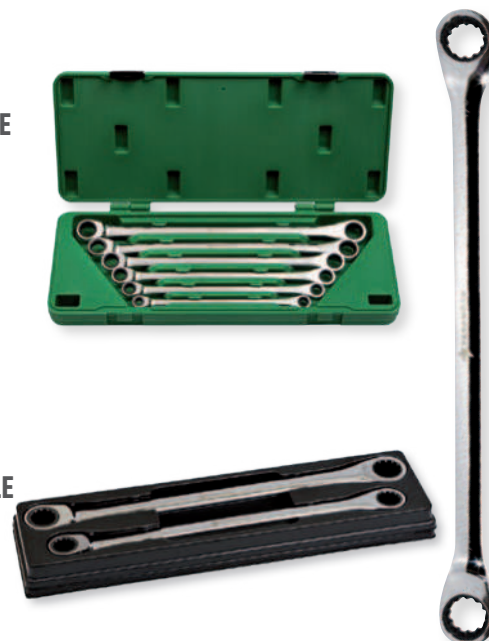



FG 606/SP9

~~128,00€~~ **78,00€**

SET 9 CHIAVI COMBinate NON REVERSIBILI IN ROTOLO DI NYLON

CONTENUTO: 8,10,11,12,13,14,15,17,19 mm



FG 610FL/SP9

~~225,00€~~ **129,00€**

SET 9 CHIAVI COMBinate A CRICCO FLESSIBILI IN ROTOLO DI NYLON

CONTENUTO: 8, 10, 12, 13, 15, 16, 17, 18, 19 mm



FG 605/SP6

~~105,00€~~ **63,00€**

SET 6 CHIAVI COMBinate REVERSIBILI IN ROTOLO DI NYLON

CONTENUTO:
8,10,13,14,17,19 mm



FG 605/SC15

~~245,00€~~ **145,00€**

SET 15 CHIAVI COMBinate A CRICCO REVERSIBILI IN BOX DI CARTONE

CONTENUTO:
6,7,8,9,10,11,12,13,14,15,16,17,18,19,22 mm

CHIAVE COMBINATA A CRICCO REVERSIBILE CON ANELLO DI TENUTA

ANELLO IN ACCIAIO INTEGRATO CHE CONSENTE LA TENUTA DEL BULLONE

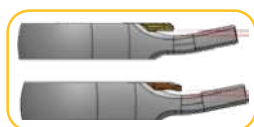

LEVA DI INVERSIONE A FILO TESTA E CON LINGUETTA INCLINATA VERSO IL BASSO PER UN MAGGIORE SPAZIO DI MANOVRA

FG 605/ST9-B

SET 9 CHIAVI A CRICCO REVERSIBILI CON SUPPORTO IN ABS

CONTENUTO: 8,10,11,12,13,14,15,17,19mm

~~180,00€~~ **105,00€**

FG 605/ST11-B

SET 11 CHIAVI A CRICCO REVERSIBILI CON SUPPORTO IN ABS

CONTENUTO: 8,9,10,11,12,13,14,15,16,17,19mm

~~220,00€~~ **129,00€**



CHIAVI A BUSSOLA

CRICCHETTO REVERSIBILE

ASOLA DI AGGANCIO

LEVA DI INVERSIONE
INTEGRATA A FILO TESTA

CROMATURA
LUCIDA

TESTA CHIUSA
ANTIPOLVERE



- Sistema di avanzamento rotativo integrato nell'impugnatura
- Meccanismo a 60 denti
- Cromatura lucida e asola di aggancio



FG 624/RT14

1/4"

CRICCHETTO REVERSIBILE DA 1/4"
CON IMPUGNATURA ROTANTE

~~63,00€~~ 38,50€

FG 625/RT12

1/2"

CRICCHETTO REVERSIBILE DA 1/2"
CON IMPUGNATURA ROTANTE

~~82,00€~~ 48,90€

FG 624/FR14

~~42,00€~~

23,90€

CRICCHETTO REVERSIBILE DA 1/4"

- Modello con testa chiusa anti polvere
- Leva di inversione integrata a filo testa
- Corpo scavato di 13° per consentire l'utilizzo anche in spazi particolarmente difficoltosi
- Meccanismo a 72 denti
- Cromatura lucida e asola di aggancio

1/4"

FG 625/FR12

~~55,00€~~

32,90€

CRICCHETTO REVERSIBILE DA 1/2"

- Modello con testa chiusa anti polvere
- Leva di inversione integrata a filo testa
- Corpo scavato di 13° per consentire l'utilizzo anche in spazi particolarmente difficoltosi
- Meccanismo a 72 denti
- Cromatura lucida e asola di aggancio

1/2"

- Sistema di inversione a ghiera integrato sulla testa
- Meccanismo a 72 denti
- Cromatura lucida
- Asola di aggancio



FG 624/CR14

1/4"

CRICCHETTO REVERSIBILE DA 1/4"
CON IMPUGNATURA BI-MATERIAL

~~40,00€~~ 22,90€

FG 625/CR12

1/2"

CRICCHETTO REVERSIBILE DA 1/2"
CON IMPUGNATURA BI-MATERIAL

~~54,00€~~ 29,90€



FG 624/S29 1/4"

SET 29 UTENSILI DA 1/4"

~~210,00€~~ **129,00€**



3/8"



4,5,6,7,8,9,10,
11,12,13,14mm



FG 624/CR14



FG 624/PA50, 100



FG 624/PRF150



FG 624/ES14

FG 624/SN14



FG 624/GR14C



FG 624/S25 1/4"

SET 25 UTENSILI
CON ATTACCO QUADRO 1/4"

~~90,00€~~ **49,00€**



FG 624/E: 6, 8,10,11,12,13mm



FG 624/CR14



FG 89/38PI1 (1/4x1/4)



FG 85/25PH1, PH2, PH3

FG 85/25PZ1, PZ2, PZ3

FG 85/25F4, F5, F6, F7

FG 85/25TX10, TX15, TX20, TX25, TX30, TX40



FG 624B/S16 3/8"

~~152,00€~~ **89,00€**

SET 16 CHIAVI A BUSSOLA
ESAGONALI 3/8" E CRICCHETTO

CONTENUTO:

8, 9, 10, 11, 12, 13, 14, 15, 16, 17, 18, 19, 21, 22, 23mm

FG 624/CR38



FG 624/S25A 1/4"

SET 25 UTENSILI CON
ATTACCO QUADRO 1/4"

~~85,00€~~ **49,00€**



FG 624/E: 5, 6, 8,10,11,13mm



FG 624/MCH14



ADATTATORE 1/4"x1/4"



FG 85/25PH1, PH2, PH3

FG 85/25PZ1, PZ2, PZ3

FG 85/25F3, F5

FG 85/25H4, H5, H6

FG 85/25TX10, TX15, TX20, TX25, TX30, TX40



FG 624B/TXS10 3/8"

SET 10 CHIAVI A BUSSOLA
EXTRA-LUNGHE TORX

CONTENUTO: E6, E7, E8, E10, E11,
E12, E14, E16, E18, E20

~~135,00€~~ **49,00€**





CHIAVI A BUSSOLA

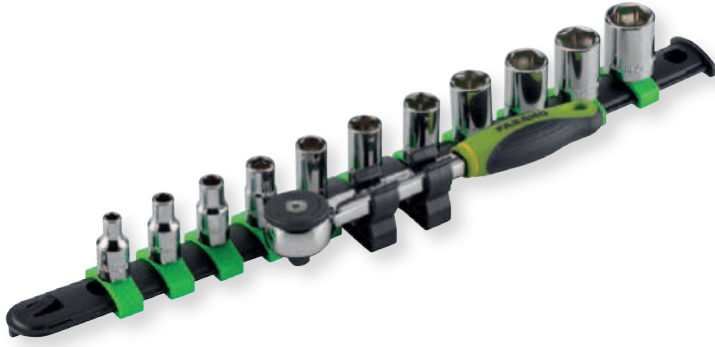

FG 624/S12 1/4" 80,00€ 49,00€

SET 11 CHIAVI A BUSSOLA ESAGONALI E CRICCHETTO SU SUPPORTO IN PLASTICA

CONTENUTO: 4, 5, 6, 7, 8, 9, 10, 11, 12, 13, 14 mm + FG 624/CR14



FG 625A/S12 1/2" 130,00€ 79,00€

SET 11 CHIAVI A BUSSOLA ESAGONALI E CRICCHETTO SU SUPPORTO IN PLASTICA

CONTENUTO: 8,10,11,12,13,14,15,16,17,18,19 + FG 625/CR12



FG 625TX/S13

SET 13 CHIAVI A BUSSOLA SNODATE CON IMPRONTA TORX

CONTENUTO:

1/4": E4,E5,E6,E7,E8

3/8": E10,E12,E14,E16

1/2": E18,E20,E22,E24

160,00€ 69,00€

1/4"

3/8"

1/2"



FG 625/S12 1/2" 120,00€ 72,00€

SET 11 CHIAVI A BUSSOLA POLIGONALI E CRICCHETTO SU SUPPORTO IN PLASTICA

CONTENUTO: 8,10,11,12,13,14,15,16,17,18,19 + FG 625/CR12



1/2"

FG 625/S27 190,00€ 99,00€

SET 27 UTENSILI DA 1/2"



FG 625/A8,9,10,11,12,13,14,15,16,17,18,19,20,21,22,23,24,25,26,27,30,32



FG 625/CR12



FG 625/SN12



FG 625/ES12



FG 625/PA125, 250

FG BEST 108

1/4"

1/2"

FG BEST 108

~~270,00€~~

139,00€



SET 108 UTENSILI DA 1/4" 1/2"



	FG 625/A10,11,12,13,14,15,16, 17,18,19,20,21,22,23,24,27,30,32		FG 87/AD
	FG 624/E4,4.5,5.5,6,7,8,9,10,11,12,13,14		FG 181/B16,21 x CANDELE ACCENSIONE
	FG 625L/A14,15,17,19,22		FG 624/CR14 FG 625/CR12
	FG 624/E/L6,7,8,9,10,11,12,13		FG 625/SN12 FG 624/SN14
	FG 625/TX10,11,12,14,16,18,20,24		FG 625/ES12 FG 624/ES14
	FG 624/TX4,5,6,7,8		FG 624/GR14
	FG 139/D1,5,2,2,5		FG 625/PR125 FG 624/PR50,100
	FG 147/PH1,PH2 FG 147/PZ1,PZ2 FG 147/SL4,SL5,5,SL6,5 FG 147/H3,H4,H5,H6 FG 147/TX10, TX15, TX20, TX25, TX30		
	FG 85/PH3,PH4 FG 85/PZ3,PZ4 FG 85/SL8,SL10,SL12 FG 85/H7,H8,H10,H12,H14 FG 85/TX40, TX45, TX50, TX55, TX60		

FG BEST 171

1/4"

3/8"

1/2"

FG BEST 171

~~400,00€~~

179,00€



SET 171 UTENSILI DA 1/4", 3/8" E 1/2"



	FG 625/A10,11,12,13,14,15,16, 17,18,19,20,21,22,23,24,27,30,32		FG 87/AD
	FG 624/B10,11,12,13,14,15,16,17,18,19		FG 181/B16,21 x CANDELE ACCENSIONE
	FG 624/E4,4.5,5.5,6,7,8,9,10,11,12,13,14		FG 625/SN12 FG 624/CR38 FG 624/SN14
	FG 625L/A16,17,18,19,22 FG 624B/L10,11,12,13,14,15 FG 624/4,5,6,7,8,9,10		FG 625/ES12 FG 624/ES14
	FG 625/TX20,24 FG 624B/TX10,11,12,14,16,18 FG 624/TX4,5,6,7,8		FG 624/GR14
	FG 181/B16,21 x CANDELE ACCENSIONE		FG 625/PR125 FG 624B/PR125 FG 624/PR50,PR100
	FG 624/CR14 FG 624/CR38 FG 625/CR12		FG 139/D1,1.5,2,2.5,3,4,4.5,5
	FG 147/PH0,PH1,PH2 FG 147/PZ0,PZ1,PZ2 FG 147/SL4,5,5,6,5,7 FG 147/H3,H4,H5 FG 147/TX8-TX30 FG 147/RTX8-RTX30		
	FG 85/PH3,PH4 FG 85/PZ3,PZ4 FG 85/SL8,SL10,SL12 FG 85/H7,H8,H10,H12,H14 FG 85/TT40-TX50 FG 85/TT10-TT45 FG 85/M5-M9		



CHIAVI A BUSSOLA

FG 625/S74

~~250,00€~~ **129,00€**

SET 74 UTENSILI CON AGGANCO 1/4" E 1/2"



FG 625/A8,9,10,11,12,13,14,15,16,17, 18,19,20,21,22,23,24,25,26,27,30,32



FG 624/E4,5,6,7,8,9,10,11,12,13,14



FG 624/CR14
FG 625/CR12



FG 625/SN12
FG 624/SN14



FG 625/ES12
FG 624/ES14



FG 624/GR14C



FG 625/PA125
FG 624/PA50, 100



FG 89/38PI1 1/4"x1/4"



FG 85/25PH1, PH2, PH3
FG 85/25SL3, SL4, SL4.5, SL5, SL5.5, SL6, L6.5
FG 85/25PZ1, PZ2, PZ3
FG 85/H1.5, H2, 2.5, H3, H4, H5, H6
FG 85/25T9, T10, T15, T20, T25, T27, T30, T40

1/4"

1/2"

FG 625/S94

~~300,00€~~ **149,00€**

SET 94 UTENSILI CON AGGANCO 1/4" E 1/2"



1/4"

1/2"



FG 625/A8,9,10,11,12,13,14,15,16,17, 18,19,20,21,22,23,24,25,26,27,30,32



FG 624/E4,5,6,7,8,9,10,11,12,13,14



FG 625L/A10,13,14,15,17,19



FG 624E/L4,5,6,7,8,9,10,11,12,13,14



FG 624/CR14
FG 625/CR12



FG 625/SN12
FG 624/SN14



FG 625/ES12
FG 624/ES14



FG 624/GR14C



FG 625/PA125, 250
FG 624/PA50, 100



FG 89/38PI1 1/4"x1/4"

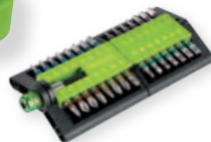

FG 85/25PH1, PH2, PH3
FG 85/25SL3, SL4, SL4.5, SL5, SL5.5, SL6, L6.5
FG 85/25PZ1, PZ2, PZ3
FG 85/H1.5, H2, 2.5, H3, H4, H5, H6
FG 85/25T9, T10, T15, T20, T25, T27, T30, T40
FG 88/60PI2

1/4"

1/2"

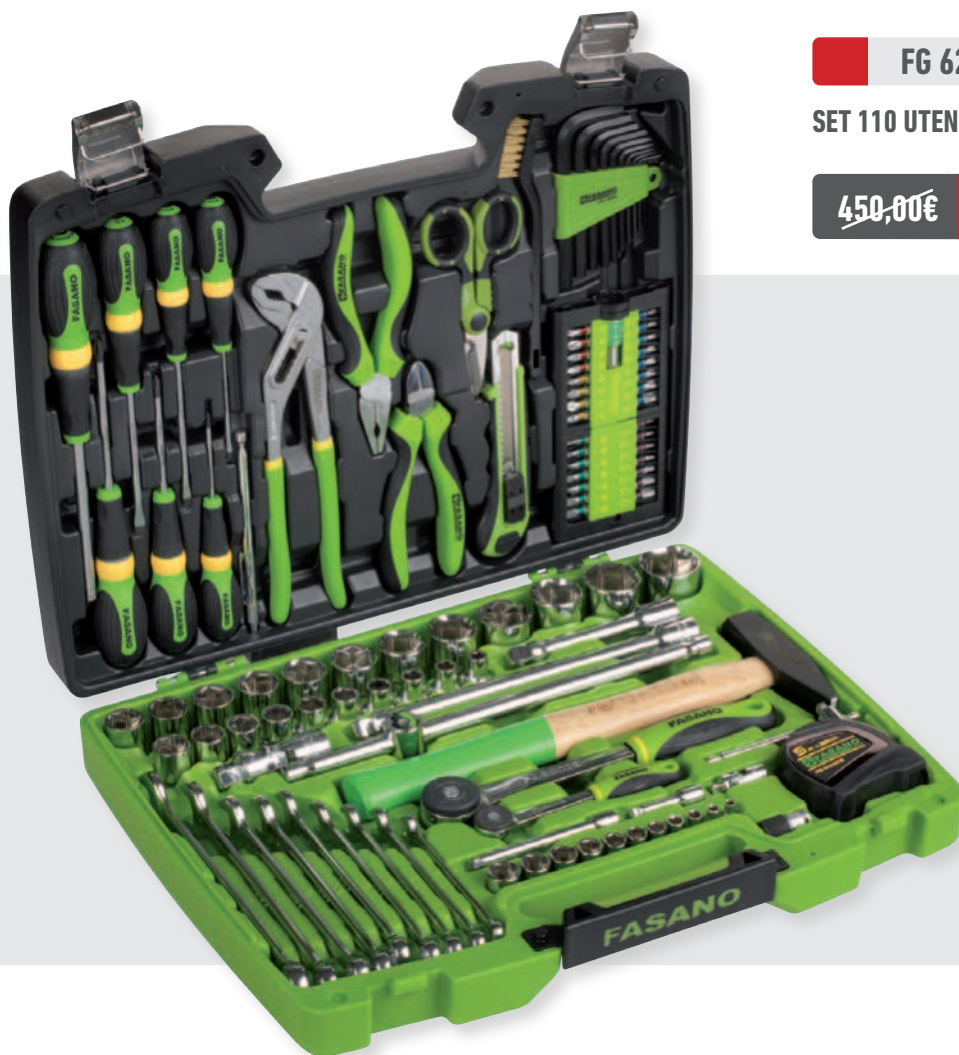

FG 625/S110

SET 110 UTENSILI DA 1/4" 1/2"

~~450,00€~~

239,00€



FG 625/A8,9,10,11,12,13,14,15,16,17,
18,19,20,21,22,23,24,25,26,27,30,32



FG 624/E4,5,6,7,8,9,10,11,12,13,14



FG 624/CR14
FG 625/CR12



FG 625/SN12
FG 624/SN14



FG 625/ES12
FG 624/ES14



FG 624/GR14C



FG 625/PA125, 250
FG 624/PA50, 100



FG 89/38PI1 1/4"x1/4"



FG 85/25PH1, PH2, PH3
FG 85/25SL3, SL4, SL4.5, SL5, SL5.5, SL6, L6.5
FG 85/25PZ1, PZ2, PZ3
FG 85/H1.5, H2, 2.5, H3, H4, H5, H6
FG 85/25T9, T10, T15, T20, T25, T27, T30, T40
FG 88/60PI2



FG 139/B



FG 48/L



FG 49



FG 600/B8,10,11,12,13,14,15,17,19



FG 22/3x75, 4x100, 5.5x100
FG 22/PH0x60, PH1x80, PH2x100



FG 59SR/160
FG 63SR/160



FG 58/B240



FG 132/H500



FG 79/SP



FG 92/PM1



FG 44/MT5



CHIAVI A BUSSOLA



FG 150TX/S32 1/2"

~~190,00€~~

115,00€

SET 32 INSERTI A BUSSOLA TORX DA 1/2"



 FG 150/TX20 - TX70

 FG 150L/TX20 - TX70

 FG 150XL/TX40 - TX70

 FG 150XXL/TX40 - TX70

FG 150M/S26

1/2"

~~180,00€~~

109,00€

SET 26 INSERTI A BUSSOLA XZN DA 1/2"



 FG 150/M5 - M16

 FG 150L/M5 - M16

 FG 150XL/M5 - M14

 FG 150XXL/M8 - M14

FG 150H/S30 1/2"

~~200,00€~~

119,00€

SET 30 INSERTI A BUSSOLA ESAGONALI DA 1/2"



 FG 150/H5 - H19

 FG 150L/H5 - H13

 FG 150XL/H5 - H14

 FG 150XXL/H5 - H12



FG 629A/S15 3/4"

SET BUSSOLE ESAGONALI DA 3/4" + ACCESSORI

~~600,00€~~

329,00€

 19,22,23,27,30,32
36,41,46,50,60mm

 FG 629/CR34

 FG 629/SN34

 FG 629/ES34

 FG 629/PR200

FG 629B/S15 3/4"

SET BUSSOLE POLIGONALI DA 3/4" + ACCESSORI

~~600,00€~~

329,00€



EXTRA-PIATTA

CHIAVI A BUSSOLA 1/2"
ESAGONALI RINFORZATE



FG 628/S12

1/2"



SET 12 CHIAVI A BUSSOLA RINFORZATE
DA 1/2" SU SUPPORTO IN PLASTICA

CONTENUTO:

10, 11, 12, 13, 14, 15, 16, 17, 18, 19, 20, 21 mm mm

~~130,00€~~

79,00€



FG 628/S6

1/2"



SET 6 CHIAVI A BUSSOLA RINFORZATE
DA 1/2" SU SUPPORTO IN PLASTICA

CONTENUTO:

22, 23, 24, 27, 30, 32mm

~~95,00€~~

55,00€



FG 625AM/S3

SET 3 ADATTATORI MAGNETICI
EXTRA PIATTI

CONTENUTO:

1/4"x3/8", 3/8"x1/2", 1/2"x3/4"

~~48,00€~~

28,90€



FG 152/RTXS10

1/2"

~~165,00€~~

99,00€

SET 10 INSERTI A BUSSOLA RINFORZATI TORX
DA 1/2" SU SUPPORTO IN PLASTICA

CONTENUTO: TX20, TX25, TX27, TX30, TX40, TX45, TX50, TX55, TX60, TX70



FG 152RM/S9

1/2"

~~125,00€~~

69,00€

SET 9 INSERTI A BUSSOLA XZN RINFORZATI
DA 1/2" SU SUPPORTO IN PLASTICA

CONTENUTO: RM5, RM6, RM8, RM9, RM10, RM12, RM14, RM16, RM18



FG 152RH/S9

1/2"

~~125,00€~~

69,00€

SET 9 CHIAVI A BUSSOLA RINFORZATE DA
1/2" ESAGONALI SU SUPPORTO IN PLASTICA

CONTENUTO: XZN5, 6, 8, 9, 10, 12, 14, 16, 18



FG 629C/S10

3/4"

~~290,00€~~

149,00€

SET 10 CHIAVI A BUSSOLA RINFORZATE
ESAGONALI DA 3/4" IN CASSETTA DI ACCIAIO

CONTENUTO: 17, 19, 22, 24, 27, 30, 32, 36, 41, 46mm



GIRAVITI E PINZE



FG 22/S6

CONTENUTO: 3x75, 4x100, 5.5x100, PH0x60, PH1x80, PH2x100



~~36,00€~~

19,90€



FG 22/S8

CONTENUTO: 3x75, 4x100, 5.5x100, 6.5x30 PH0x60, PH1x80, PH2x100, PH2x30



~~48,00€~~

26,90€



FG 22/S8B

CONTENUTO: 2.5x75, 3.5x100, 4x100, 6.5x150, 8x150, PH0x60, PH1x80, PH2x150



~~52,00€~~

29,90€



FG 22/S10

CONTENUTO: 2.5x60, 3x75, 4x100, 5.5x150, 6.5x150, 4x30, PH0x60, PH1x80, PH2x100, PH1x30



~~65,00€~~

36,90€



FG 22/S12

CONTENUTO: 2.5x60, 3x75, 4x100, 5.5x150, 6.5x150, 8x150, 4x30, PH0x60, PH1x80, PH2x100, PH3x150, PH1x30



~~90,00€~~

52,90€



FG 22TX/S6

CONTENUTO: TX10, TX15, TX20, TX25, TX27, TX30



~~65,00€~~

37,90€



FG 22FL/S6

SET 6 GIRAVITI A BUSSOLA ESAGONALE
CON ASTA FLESSIBILE RIVESTITA IN GOMMA

CONTENUTO: 5, 5.5, 6, 7, 8, 10 mm

~~127,00€~~ **75,00€**



FG 22FX/S10

SET 6 GIRAVITI A BUSSOLA
ESAGONALE CON ASTA FISSA

CONTENUTO: 5, 5.5, 6, 7, 8, 9, 10, 11, 12, 13 mm

~~140,00€~~ **85,00€**



FG 139/B

SET 10 CHIAVI MASCHIO A L
ESAGONALI - SERIE CORTA

1.5, 2, 2.5, 3, 4, 5, 5.5, 6, 8, 10mm

~~16,00€~~ **8,90€**

FG 139/C

SET 10 CHIAVI MASCHIO A L
ESAGONALI - SERIE LUNGA

1.5, 2, 2.5, 3, 4, 5, 6, 8, 10mm

~~23,00€~~ **12,90€**



FG 139/D

SET 10 CHIAVI MASCHIO A L
ESAGONALI - SERIE CORTA

1.5, 2, 2.5, 3, 4, 5, 5.5, 6, 8, 10mm

~~21,00€~~ **11,90€**

FG 139/E

SET 10 CHIAVI MASCHIO A L
ESAGONALI - SERIE LUNGA

1.5, 2, 2.5, 3, 4, 5, 6, 8, 10mm

~~32,00€~~ **18,90€**



FG 139

SET 12 CHIAVI MASCHIO A L
ESAGONALI - SERIE SFERICA

1.5, 2, 2.5, 3, 4, 4.5, 5, 5.5, 6, 7, 8, 10mm

~~36,00€~~ **21,90€**

FG 139/L

SET 12 CHIAVI MASCHIO A L
ESAGONALI - SERIE LUNGA

1.5, 2, 2.5, 3, 4, 4.5, 5, 5.5, 6, 7, 8, 10mm

~~40,00€~~ **22,90€**

TESTA SFERICA



FG 139/S9

SET 9 CHIAVI MASCHIO A L
ESAGONALI E LATO CORTO 110°

CONTENUTO: 1.5 - 10.0mm

~~39,00€~~ **19,90€**

TESTA SFERICA



GIRAVITI E PINZE



FG 138/BP

SET 9 CHIAVI MASCHIO TORX A L E TESTA SFERICA

CONTENUTO:
TX8,10,15,20,25,27,30,40,50

~~68,00€~~ **33,90€**

TESTA SFERICA



FG 138

SET 12 CHIAVI MASCHIO TORX A L

CONTENUTO:
TX7,X8, 9, 10,15,20,25,27,30,40,45, 50

~~55,00€~~ **29,90€**



FG 139/LM

SET 10 CHIAVI MASCHIO A L ESAGONALI MAGNETICHE

CONTENUTO: 1.5, 2, 2.5, 3, 4, 5, 6, 7, 8, 10mm

~~50,00€~~ **29,90€**

ESTREMITÀ MAGNETICA

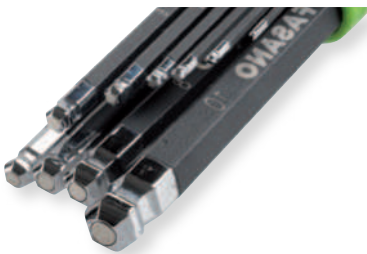

FG 138/M

SERIE 10 CHIAVI MASCHIO A L TORX MAGNETICHE

CONTENUTO: TX9 - TX50

~~58,00€~~ **34,90€**

ESTREMITÀ MAGNETICA

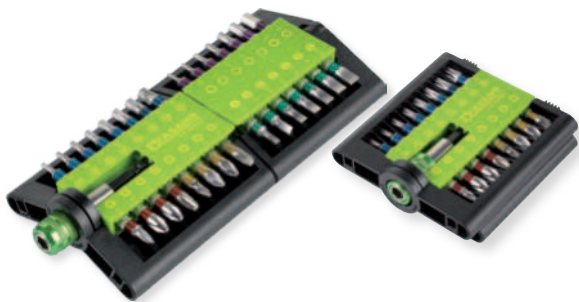

FG 85/S31

SET 31 INSERTI DA 1/4", LUNGHEZZA 25MM, + ADATTATORE PORTA INSERTI 1/4"X1/4"

CONTENUTO:

- FG 88/60P13
- FG 85/25PH1, PH2, PH3
- FG 85/25SL3, SL4, SL4.5, SL5, SL5.5, SL6, SL6.5
- FG 85/25PZ1, PZ2, PZ3
- FG 85/H1.5, H2, 2.5, H3, H4, H5, H6
- FG 85/25T9, T10, T15, T20, T25, T27, T30, T40



~~65,00€~~ **35,00€**

FG 86/S30

SET 28 INSERTI ATTACCO 10MM + ADATTATORI

CONTENUTO:

- FG 86/30T10- T40, FG 86/75T10 - T40
- FG 86/30H4,5,6 - FG 86/75H4,5,6
- FG 86/30M4-M10 - FG 86/75M4-M10
- 2 ADATTATORI PORTA INSERTI 1/2" x 10mm



~~85,00€~~ **49,90€**



FG 86/S30B

SET 28 INSERTI ATTACCO 10MM + ADATTATORI

CONTENUTO:

- FG 86/30T10- T40, FG 86/75T10 - T40
- FG 86/30TT10- TT40, FG 86/75TT4 - TT40
- ADATTATORE PORTA INSERTI 1/2" x 10mm



~~85,00€~~ **49,90€**

20+ MODELLI

SCOPRILI TUTTI SUL CATALOGO GENERALE

NEW

CAPACITÀ DI TAGLIO FINO A 6mm*

Il dato si riferisce al valore massimo coperto dalla gamma

FINITURA LUCIDA

DUREZZA ACCIAIO HRC 63

NUOVE PINZE INDUSTRIAL



NEW



FG 59XT/S3

~~85,00€~~ **49,90€**

SET 3 PINZE ASSORTITE

CONTENUTO: FG 59/XT180, FG 61/XT160, FG 63/XT160

FG 59XT/S3B

~~95,00€~~ **57,90€**

SET 3 PINZE ASSORTITE

CONTENUTO: FG 59/XT180, FG 61/XT200, FG 63/H180



FG 59PV/S3

~~68,00€~~ **39,90€**

SET 3 PINZE, CON MANICI IN DOPPIO STRATO DI PVC

FG 59PV/160, FG 61PV/160, FG 63PV/160



FG 51/S4

~~95,00€~~ **55,00€**

SET 4 PINZE PER ANELLI ELASTICI 10-25MM

FG 51/S4B

~~100,00€~~ **59,00€**

SET 4 PINZE PER ANELLI ELASTICI 19-60MM

"INSERTI RINFORZATI PER ANELLI DI GRANDE TENUTA"



FG 55/S4

~~130,00€~~ **75,00€**

SET 4 PINZE PER ANELLI ELASTICI CON INSERTI RINFORZATI IN ACCIAIO 10-25MM

FG 55/S4B

~~135,00€~~ **79,00€**

SET 4 PINZE PER ANELLI ELASTICI CON INSERTI RINFORZATI IN ACCIAIO 19-60MM



 **ELETRONICA E ELETTROTECNICA**

FG 22E/S6

SET 6 GIRAVITI ISOLATI

CONTENUTO: 3X100, 4X100, 5.5X125, PH0X60, PH1X80, PH2X100



~~58,00€~~ **32,90€**

FG 22E/SZ6

SET 6 GIRAVITI ISOLATI

CONTENUTO: 3x100, 4x100, 5.5x125 PZ0x60, PZ1x80, PZ2x100



~~58,00€~~ **32,90€**



FG 59IS/S3

SET 3 PINZE CON MANICI ISOLATI

CONTENUTO: FG 59/IS180, FG 61/IS200, FG 63/IS160

~~118,50€~~ **59,90€**



FG 68/CC

TAGLIACAVI PER CAVI IN RAME - NON ISOLATO

Capacità: 255mm² - Ø 32mm

~~168,00€~~ **89,00€**

FG 68/TC230

TAGLIACAVI PER CAVI IN RAME E ALLUMINIO

Capacità: Ø 17mm

~~83,00€~~ **49,00€**

FG 68/AT6

PINZA PER CAPICORDA TUBETTO

~~65,00€~~ **29,00€**



FG 68/AT16

PINZA PER CAPICORDA TUBETTO

~~65,00€~~ **29,00€**



FG 68/AG

PINZA PER CAPICORDA PREISOLATI

~~65,00€~~ **29,00€**



FG 68/SP

PINZA TAGLIA E SPELLAFILI
PER CAPICORDA ISOLATI

~~34,00€~~ **19,90€**



FG 68/SP2

SPELLAFILI FRONTALE, DOTATA
DI INCAVO SPELLAFILI

~~14,50€~~ **8,90€**



FG 96/DG

MULTIMETRO DIGITALE DC/AC - OHM

FUNZIONI AGGIUNTIVE:

- MISURAZIONE TEMPERATURA
- MISURAZIONE DI UMIDITÀ
- MISURAZIONE LUX
- MISURAZIONE DEL SUONO

~~185,00€~~ **99,00€**



FG 68/RJ

PINZA PER CONNETTORI
RJ A 4, 6 E 8 POLI

~~73,00€~~ **39,00€**



FG 68/BNC

PINZA PER CONNETTORI BNC
PER CAVI COASSIALI
RG58, RG62 E RG71

~~94,00€~~ **45,00€**



FG 68U/S439

~~290,00€~~ **169,00€**

SET PINZA UNIVERSALE + 3 MATRICI
(FG 68/MAT4, FG 68/MAT16, FG 68/MAG),
CON ASSORTIMENTO 435 CAPICORDA ISOLATI



FUNZIONE

DC	0.4 V , 4 V , 40 V , 400 V , 600V (± 0.7%)
AC	4 V , 40 V , 400 V , 600V (± 0.8%)
Ω	400 Ω , 4K Ω , 400kΩ , 4MΩ (± 1.2) 40MΩ (± 2.0%)
CAPACITA'	4nF , 40nF , 400nF , 4μF , 40 μF , 200 μF (± 3.0%)
FREQUENZA	10Hz , 100Hz , 1kHz , 10kHz , 100kHz (± 2.0%)
DUTY CYCLE	0.1% - 99.9% (± 3.0%)
TEST DI CONTINUITA'	sì
PROVA DIODI	sì
TEMPERATURA	-20°C - 400°C (± 3.0% / 0.1°C) -20°C - 1.000°C (± 3.0% / 1°C)
CAPACITA' RILEVAZIONE UMIDIDTA'	30% - 95% RH ((± 5.0%)
LUX	4.000 Lux / 40.000 Lux ((± 5.0%)
CAPACITA' RILEVAZIONE SUONO	35 - 100dB ((± 4dB)
STANDBY	Dopo 15 minuti
INDICATORE LIVELLO BATTERIA	Sì
BATTERIA	9V
DIMENSIONE	8x3.5x16.5H mm



ELETTRONICA E ELETTROTECNICA

CHIAVI DINAMOMETRICHE PER SERRAGGI DESTROSI E SINISTROSI

PRECISIONE DI SERRAGGIO: $\pm 4\%$

IMPUGNATURA ERGONOMICA IN POLIPROPILENE SOFT-TOUCH

QUADRANTE CON DOPPIA SCALA NM E LBS CON NUMERI DI FACILE LETTURA

SISTEMA DI INVERSIONE A GHIERA INTEGRATO SULLA TESTA

CROMATURA LUCIDA

MECCANISMO A 72 DENTI CON 5° DI RIPRESA

SISTEMA DI REGOLAZIONE CONTROLLATO CON AVVICINAMENTO SOFT

MECCANISMO INTERNO INTERAMENTE IN ACCIAIO DOTATO DI CUSCINETTO A SFERE



CERTIFICATO DI TARATURA FORNITO DI SERIE ALL'ACQUISTO



CHIAVI DINAMOMETRICHE A DISINNESTO E ATTACCO QUADRO

CODICE	RISOLUZIONE	NM	LISTINO	€/PROMO	
FG 531	0.1Nm	5-25Nm	205,00	119,00	1/4"
FG 533/2	0.25Nm	10-50Nm	230,00	135,00	3/8"
FG 536/1	0.5Nm	20-100Nm	230,00	135,00	1/2"
FG 536/2	1.0Nm	40-200Nm	250,00	139,00	1/2"
FG 536/3	2.0Nm	60-340Nm	255,00	156,00	1/2"

BARRE DINAMOMETRICHE A DISINNESTO E ATTACCO QUADRO

CODICE	NM	LISTINO	€/PROMO	
FG 538/1	140-560	880,00	459,00	3/4"
FG 538/2	200-800	880,00	519,00	3/4"
FG 539/1	200-1.000	1.150,00	659,00	1"

GRADO DI PRECISIONE: $\pm 4\%$

FORNITA IN CASSETTA DI ABS

CHIAVI DINAMOMETRICHE DIGITALI PER NM E GRADI

1/2"

CODICE	NM	LISTINO	€/PROMO
FG 543/DG1	16.8-135	630,00	379,00
FG 543/DG2	10-200	740,00	449,00

- Doppia modalità di misurazione: PICCO e TRACCIA
- Indicatore sonoro e visivo a 12 led al raggiungimento della coppia prefissata
- Possibilità di memorizzare fino a 250 differenti serraggi grazie al software PC incluso nel kit Interfaccia PC tramite presa USB
- Possibilità di impostare fino a 9 serraggi predefiniti
- Alimentazione: 2 batterie 1.5V (incluse)



1/2"

FG 546/DG

310,00€ 189,00€

GONIOMETRO DIGITALE PER SERRAGGI IN COPPIA E ANGOLARI

PRECISIONE DI SERRAGGIO: $\pm 2\%$

- Doppia modalità di misurazione: PICCO e TRACCIA
- Indicatore sonoro e visivo a 6 led al raggiungimento della coppia prefissata
- Possibilità di memorizzare fino a 50 serraggi differenti
- Alimentazione: 2 batterie 1.5V (incluse)



FG 547/DG

195,00€ 119,00€

GONIOMETRO DIGITALE PER SERRAGGI ANGOLARI

PRECISIONE DI SERRAGGIO: $\pm 2\%$

- Indicatore sonoro e visivo a 6 led al raggiungimento della coppia prefissata
- Dotato di supporto magnetico posteriore



MOLTIPLICATORE DI COPPIA DESTRO/SINISTRO

CODICE	□ X ■	RAPPORTO	Nm	Lbf.ft	LISTINO	€/PROMO
FG 581/A	1/2"x3/4"	1:6.5	231-1.500	1.106	800,00	489,00
FG 581/B	1/2"x1"	1:12	208-2.500	1.844	1.320,00	809,00

GIRAVITE DINAMOMETRICO A TARATURA LIBERA

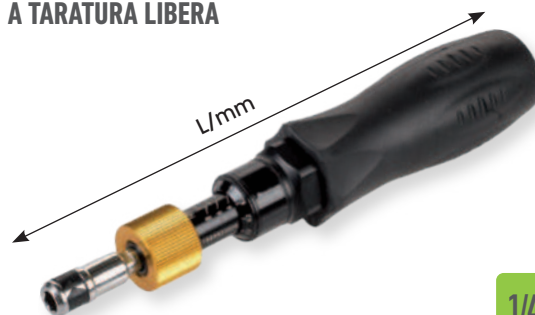

1/4"

CODICE	NM	L/MM.	LISTINO	€/PROMO
FG 559/1	0.1 - 1.2	155	210,00	119,00
FG 559/2	1 - 6	155	220,00	129,00
FG 559/3	5 - 10	155	225,00	135,00

PRECISIONE DI SERRAGGIO: $\pm 6\%$



UTENSILI DA TAGLIO



FG 70/S110

~~335,00€~~ **195,00€**

SET MASCHI E FILIERE IN ACCIAIO AL CROMO + ACCESSORI - 110PZ
PASSO GROSSO E FINE - FILETTATURA METRICA

						ACCESSORI
2x.04	6x0.75	12x1	2x0.4	6x0.75	12x1	GF25x9
3x0.5	7x0.75	12x1.25	3x0.5	7x0.75	12x1.25	GF8x14
4x0.7	8x0.75	12x1.5	4x0.7	8x0.75	12x1.5	GMM1.5
5x0.8	8x1	14x1	5x0.8	8x1	14x1	GMM3
6x1	9x0.75	14x1.25	6x1	9x0.75	14x1.25	GMC1
7x1	9x1	14x1.5	7x1	9x1	14x1.5	
8x1.25	10x0.75	16x1	8x1.25	10x0.75	16x1	
9x1.25	10x1	16x1.5	9x1.25	10x1	16x1.5	
10x1.5	10x1.25	18x1.5	10x1.5	10x1.25	18x1.5	
11x1.5	11x0.75		11x1.5	11x0.75		
12x1.75	11x1		12x1.75	11x1		
14x2	11x1.25		14x2	11x1.25		
16x2	12x0.75		16x2	12x0.75		



FG 75TIN/S25

SET 25 PUNTE ELICOIDALI CILINDRICHE IN ACCIAIO HSS -TIN 5% RETTIFICATE
1 - 13 X0,5MM

~~185,00€~~ **109,00€**



FG 75CO/S25

SET 25 PUNTE ELICOIDALI CILINDRICHE IN ACCIAIO HSS-COBALTO 5% RETTIFICATE
1 - 13 X0,5MM

~~230,00€~~ **135,00€**



FG 78HSS/S12

SET 9 FRESE A TAZZA IN ACCIAIO HSS BI-METAL + ACCESSORI

~~220,00€~~ **129,00€**

FG 48/B

**CUTTER A SERRAMANICO
CON LAMA TRAPEZOIDALE**
- CON 3 LAME DI RICAMBIO

~~21,00€~~ **12,90€**



FG 48/K12

**KIT 12 LAME TRAPEZOIDALI
PER FG 48/B**

~~8,00€~~ **4,90€**



FG 48/L9

**CUTTER EXTRA PIATTO
CON LAMA 9MM**

~~7,00€~~ **3,90€**



FG 48/KL9

**KIT 10 LAME TRAPEZOIDALI
PER FG 48/L9**

~~6,00€~~ **3,50€**



FG 49/TC

~~39,50€~~ **23,90€**

**FORBICE DA ELETTRICISTA,
DOTATA DI INCAVO SPELLAFILI
E CORPO INTEGRALMENTE IN ACCIAIO**

- L/MM 140 - A/MM 65MM
- LAMA MICRODENTATA IN ACCIAIO
- HRC: 56
- STRUTTURA INTEGRALE IN ACCIAIO INOX
- TAGLIACAVI 12MM
- CON SUPPORTO PER CINTURA

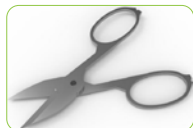

**STRUTTURA INTERAMENTE
IN ACCIAIO FORGIATO**



FG 49/TCX

~~46,00€~~ **27,90€**

**FORBICE DA ELETTRICISTA, DOTATA
DI INCAVO SPELLAFILI E CORPO
INTEGRALMENTE IN ACCIAIO**

- L/MM 160 - A/MM 50MM
- LAMA MICRODENTATA IN ACCIAIO
- HRC: 56
- STRUTTURA INTEGRALE IN ACCIAIO INOX
- TAGLIACAVI 15MM
- CON SUPPORTO PER CINTURA

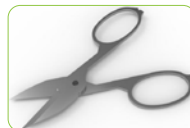

**STRUTTURA INTERAMENTE
IN ACCIAIO FORGIATO**



FG 49/L

~~17,00€~~ **9,90€**

**FORBICE MULTIUSO A
LAME LUNGHE IN ACCIAIO INOX**
L/MM 200 - A/MM 87MM
APERTURA MAX 151MM

HRC: 52-54



FG 49/MU

~~26,50€~~ **15,90€**

**FORBICI MULTIUSO CON GOLA
SPELLAFILI E LAME IN ACCIAIO
INOX ZIGRINATE**
HRC: 52-54



FG 77/PVC4

~~70,00€~~ **39,00€**

TRONCATUBI A CRICCO

- SISTEMA A CREMAGLIERA CON AVANZAMENTO PROGRESSIVO
- DOTATA DI PIATTAFORMA IN NYLON CHE FACILITA IL TAGLIO DI PROFILI PIATTI
- Ø: 0-42MM

TUBO IN PVC





MANUTENZIONE GENERALE



FLESSOMETRO CON CASSA IN ABS ANTI-SHOCK E NASTRO IN ACCIAIO RIVESTITO IN NYLON CLASSE II

CODICE	L/MM	BANDA	LISTINO	€/PROMO
FG 44/MT3	3	16MM	11,00	6,50
FG 44/MT5	5	25MM	18,00	10,90
FG 44/MT8	8	25MM	24,00	13,90
FG 44/MT10	10	25MM	29,00	16,90



FLESSOMETRO CON CASSA IN ABS E NASTRO IN ACCIAIO RIVESTITO IN NYLON CLASSE II

CODICE	L/MT	BANDA	LISTINO	€/PROMO
FG 43/MT3	3	16MM	6,30	4,20
FG 43/MT5	5	29MM	8,50	5,50

FG 95/CA

CALIBRO A CORSOIO, LETTURA CINQUANTESIMALE
- L/MM: 150



~~50,00€~~ **28,90€**

FG 95/DG

CALIBRO A CORSOIO, DIGITALE
- L/MM: 150



~~90,00€~~ **52,50€**



MARTELLO TIPO TEDESCO CON MANICO IN RESINA

CODICE	gr	L/mm	LISTINO	€/PROMO
FG 132/200	200	294	17,70	9,90
FG 132/300	300	297	19,50	11,90
FG 132/500	500	312	20,50	12,50
FG 132/800	800	342	26,00	15,90
FG 132/1000	1000	343	28,50	16,90

FG 127/S1

SET SCALPELLI E PUNZONI



~~48,00€~~ **27,90€**

FG 128C/S6

SET 6 CACCIASPINE
- MISURE: 2,3,4,5,6,8MM



~~45,00€~~ **26,90€**

FG 128P/S6

SET 6 PUNZONI
- MISURE: 1,2,3,4,5,6MM



~~40,00€~~ **23,90€**

FG 712/L4

PORTA MINUTERIE A RIPIANI GIREVOLI

- FORNITO CON DIVISORI INTERNI
- DOTATO DI 4 RIPIANI GIREVOLI E VASCETTA SUPERIORE PORTA MINUTERIE
- MATERIALE: ABS RESISTENTE AGLI URTI
- DOTATO DI 4 PIEDI D'APPOGGIO



~~120,00€~~ **49,00€**

FG 128/S11

SET 11 UTENSILI DA PERCUSSIONE CON IMPUGNATURA



~~116,00€~~ **69,00€**

FG 92/PM4

PROLUNGA MAGNETICA
TELESCOPICA (165-622MM)



~~27,50€~~ **12,90€**



FG 92/GR

PROLUNGA MAGNETICA FLESSIBILE
- CAPACITÀ 1KG - LUNGHEZZA: 700MM

CON GRIFFE PRENSILI



~~26,50€~~ **14,90€**

FG 92/PF

PROLUNGA MAGNETICA CON ASTA FLESSIBILE
CAPACITÀ 3.5KG

LUNGHEZZA
ASTA: 400MM



ASTA
DA 1 METRO

~~27,50€~~ **12,90€**

FG 92/PM

PROLUNGA MAGNETICA
CON ASTA FLESSIBILE

~~19,00€~~ **10,90€**



CE



FG 98/GAS

SALDATORE PORTATILE A GAS

- TEMPERATURA MAX: 210-450°C
- 25 WATT
- AUTONOMIA: 120 MIN CONTINUATIVI
- FORNITO CON PUNTE PER SALDARE, TAGLIARE E SOFFIARE

~~120,00€~~ **72,00€**

CE



FG 98/LT

SALDATORE PORTATILE CON BATTERIA AL LITIO

- TEMPERATURA MAX: 600°C
- AUTONOMIA: 40MIN CONTINUATIVI
- TEMPO DI RICARICA: 3.5H
- FORNITO CON PUNTE PER SALDARE, TAGLIARE E SOFFIARE

~~170,00€~~ **99,00€**

FG 98/ST8

MINI SALDATORE CON ATTACCO USB

- MAX TEMPERATURA: 480 °C

~~16,50€~~ **9,90€**



CE

FG 98/PC8

MINI CUTTER PER PLASTICA CON ATTACCO USB

- MAX TEMPERATURA: 400 °C

~~16,50€~~ **9,90€**



CE

FG 96/SS30

SALDATORE A STILO

- 30 WATT - 230V - Ø/mm 4 - 430 °C
- CLASSE DI PROTEZIONE: I

~~48,00€~~ **28,90€**



CE

FG 96/SS60

SALDATORE A STILO

- 60 WATT - 230V - Ø/mm 6 - 500 °C
- CLASSE DI PROTEZIONE: I

~~60,00€~~ **36,00€**

FG 494/S12

PISTOLA PER COLLA A CALDO
- KIT COMPLETO DI 12 STICK
DI COLLA TERMOFUSIBILE

~~55,00€~~ **32,90€**



CE

- POTENZA NOMINALE DI RISCALDAMENTO: 80W
- TEMPERATURA DI ESERCIZIO: 193°C (383°F)
- TEMPO DI RISCALDAMENTO: 3/5 MIN
- LUNGHEZZA STICK COLLA: 200MM
- DIAMETRO STICK COLLA: 11.5MM

FG 494/A180

**PISTOLA PROFESSIONALE
PER COLLA A CALDO**

~~165,00€~~ **99,00€**



CE

- POTENZA NOMINALE DI RISCALDAMENTO: 180W
- TEMPERATURA DI ESERCIZIO: 193°C (383°F)
- TEMPO DI RISCALDAMENTO: 3/5 MIN
- LUNGHEZZA STICK COLLA: 100,250,300MM
- DIAMETRO STICK COLLA: 11/11.5MM



FG 93/M50

**SPECCHIETTO TELESCOPICO
E ARTICOLATO IN ACCIAIO**



~~30,00€~~ **17,90€**

FG 93/M95

**SPECCHIETTO TELESCOPICO
E ARTICOLATO IN ACCIAIO**



~~30,00€~~ **17,90€**



FG 125/S3

**SET 3 LEVE IN ACCIAIO
CON TESTA A BATTERE**
CONTENUTO: 300, 450, 600MM

~~65,00€~~ **39,00€**

**PISTOLA PER SIGILLANTE
CON TUBO IN ACCIAIO**



CODICE	CAPACITA'	L/mm	L/mm TUBO	LISTINO	€/PROMO
FG 493/AL2	400CC	480	280	46,00	26,90
FG 493/AL3	600CC	580	380	55,00	32,90

FG 493/N

~~38,50€~~ **23,50€**

**PISTOLA PER SIGILLANTE
CON TUBO IN ALLUMINIO**

- DOTATA DI FUNZIONE
ANTI-GOCCIA



FG 97/T2

**TERMOMETRO DIGITALE
AD INFRAROSSI**

RANGE DI MISURAZIONE: -32°C - 1.650°C

~~620,00€~~ **199,00€**



CE

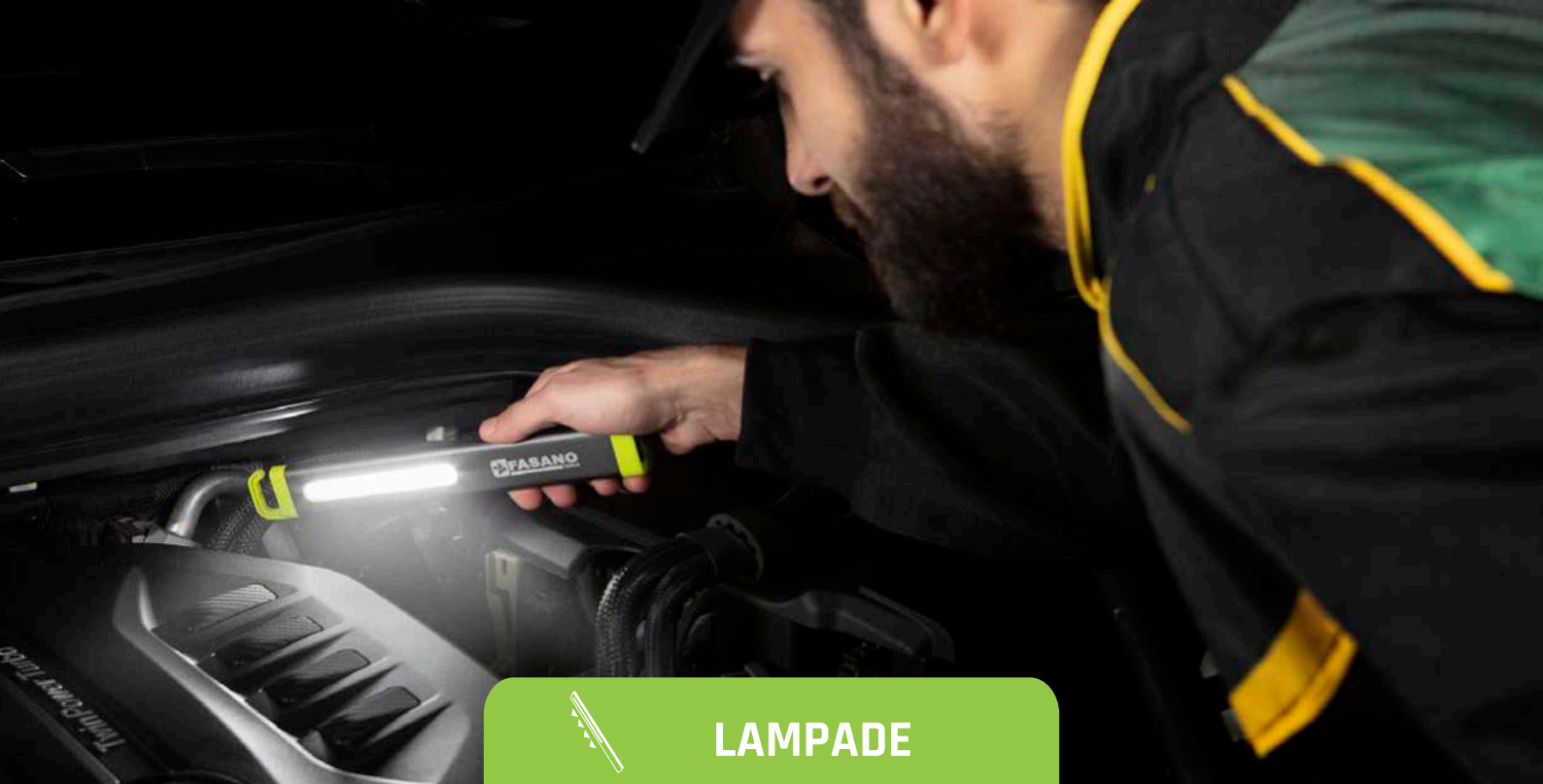

LAMPADE

FG 204

MINI LAMPADA PORTATILE A LED
BATTERIA AL LITIO LUNGA DURATA

~~30,00€~~ **17,90€**

300 LUMEN

- 300 lumen
- Li-Ion battery
- 12.5h
- Max 3h

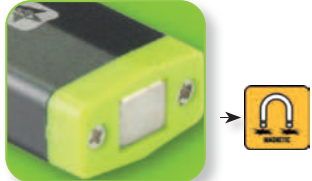

DOTATA DI SISTEMA
MAGNETICO



FG 206

LAMPADA RICARICABILE A LED

~~55,00€~~ **29,90€**

360 LUMEN

CE

- 360 LUMEN
- LI-ION BATTERY
- IPX4
- MAX 3 H



**COMPATTA, TASCABILE, POTENTE
PORTALA SEMPRE CON TE!**



EXTRA-PIATTA



**ULTRA SOTTILE, SNODATA
E DOTATA DI LED SUPERIORE**

FG 207

LAMPADA RICARICABILE A LED

~~65,00€~~ **33,90€**



300 LUMEN

100 LUMEN



BASE MAGNETICA



DOPPIA PORTA DI RICARICA
TIPO C E MICRO USB



ORIENTABILE A 360°

FG 210/A

MINI FARETTO PORTATILE A LED

~~90,00€~~ **49,90€**

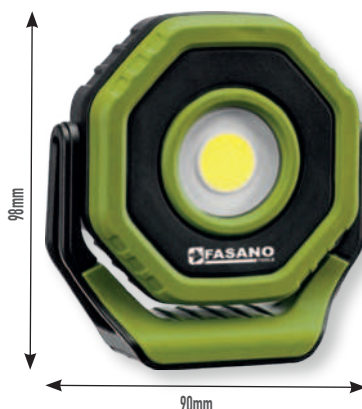

700 LUMEN



FG 203

NEW



MINI FARETTO PORTATILE A LED
DOTATO DI MAGNETI POSTERIORI, FUNZIONE
DI GESTIONE DELL'INTENSITA', DOPPIA PORTA PER RICARICA.
INCLUSO CAVO DI RICARICA USB.
CORPO IN ALLUMINIO ANODIZZATO
FUNZIONE DIMMER

~~25,00€~~ **12,90€**



**PORTATILE, MANEGGEVOLE
RICARICABILE**



LAMPADE



**LUMINOSITA' REGOLABILE
E DOTATA DI LED SUPERIORE**

ORIENTABILE A 360°

FG 211

~~110,00€~~ **59,00€**

LAMPADA RICARICABILE A LED

600 LUMEN

FG 212

~~78,00€~~ **39,00€**

LAMPADA RICARICABILE A LED

200 LUMEN



CE

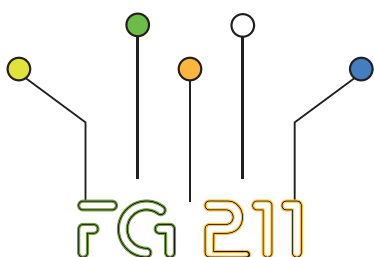

TOP LED DI PUNTAMENTO



ORIENTABILITÀ A 360°



REGOLATORE D'INTENSITÀ



INDICATORE DI CARICA



BASE MAGNETICA E GANCIO ESTRAIBILE



CE



FG 213/L480

~~65,00€~~ **39,00€**

LAMPADA DA TESTA A DOPPIO LED CON
SENSORE ON/OFF CONTACTLESS

480 LUMEN



SENSORE ON/OFF
CONTACTLESS



4 LIVELLI DI
INCLINAZIONE



DOTATA DI 4 MAGNETI POSTERIORI
PER L'UTILIZZO SENZA BANDA ELASTICA



FG 214/L600

~~85,00€~~ **39,00€**

TORCIA RICARICABILE A LED

600 LUMEN



CONO LUMINOSO
REGOLABILE



PIASTRA DI SUPPORTO
A PARETE IN DOTAZIONE



**CON UN SEMPLICE GESTO
DAI LUCE AL TUO LAVORO!**

600 LUMEN DURATA MAX 15H

LAMPADE

1.200 LUMEN



FG 209

~~260,00€~~ 149,00€



LAMPADA SOTTOCOFANO RICARICABILE
A LED CON LENTE TRASPARENTE E SEMITRASPARENTE

1200 LUMEN



BRIGHT MODE

1100 LUMEN



COMFORTABLE MODE

600 LUMEN



SOFT MODE

INDICATORE DI CARICA



ESTRAIBILE 760MM



1.200 LUMEN



FG 208

~~230,00€~~ 119,00€

LUNGHEZZA REGOLABILE:
1.300-2.060MM



LAMPADA PORTATILE
INTEGRATA E REMOVIBILE



DOTATA DI SISTEMA
MAGNETICO



LAMPADA SOTTO COFANO
RICARICABILE A LED



FG 205

LAMPADA PORTATILE A LED

DOTATA DI LED SUPERIORE, GANCIO ESTRAIBILE, BASE D'APPOGGIO MAGNETICA E ROTANTE FINO A 180°. INCLUSO CAVO DI RICARICA USB TIPO C.

~~85,00€~~

49,00€

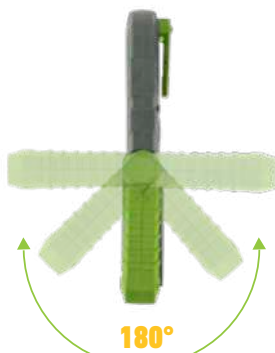

ROTAZIONE BASE
FINO A 180°



LED SUPERIORE



GANCIO ESTRAIBILE



INDICATORE DI CARICA



DOTATA DI SISTEMA
MAGNETICO

420 LUMEN



420 LUMEN

FG 210/B

LAMPADA A TUBO PORTATILE A LED

DOTATA DI LUCE SPOT SUPERIORE, BASE MAGNETICA, MODALITA' LUCE ROSSA D'EMERGENZA. INCLUSO CAVO DI RICARICA USB TIPO C. FUNZIONE DIMMER

~~85,00€~~

49,00€

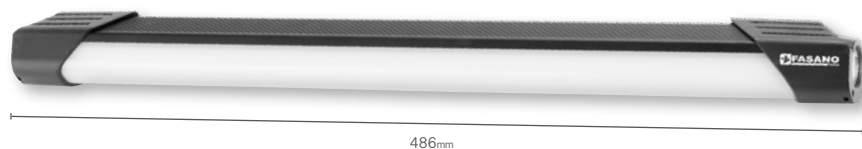

486mm



SISTEMA DI AGGANCIAMENTO
MAGNETICO



RICARICA USB TIPO C



LUCE SPOT 400 LUMEN



LUCE FRONTALE BIANCA 1200 LUMEN
LUCE FRONTALE ROSSA 50 LUMEN

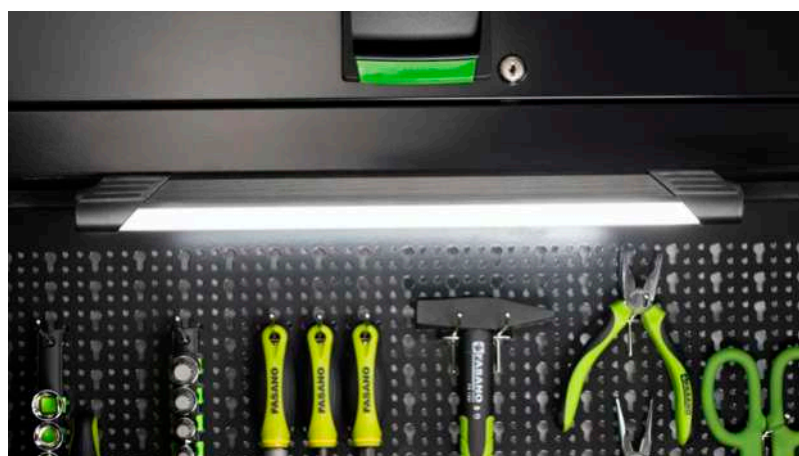

CE

NEW

FG 217

LAMPADA A 3 FARI LED,
PORTATILE E RICARICABILE
DOTATA DI SUPPORTO TELESCOPICO
REGOLABILE IN ALTEZZA.
INCLUSO CAVO DI RICARICA USB TIPO C.

~~250,00€~~ 149,00€



2.000 LUMEN



GANCIO ESTRAIBILE



MAGNETE



LUCE FREDDA

LUCE CALDA



PANNELLO DI CONTROLLO



**3 FARI LED DOTATA DI
SUPPORTO REGOLABILE IN ALTEZZA**

NEW



CE

FG 225/SK1.5

~~300,00€~~ **149,00€**

AVVOLGITORE AUTOMATICO 15M
3GX1.5MM² CON PRESA SCHUKO
LUNGHEZZA CAVO IN INGRESSO 1,20M

15m x 3G 1.5mm² ⚡ 1000W
— 230V AC — 2000W

FG 225/SK2.5

~~370,00€~~ **169,00€**

AVVOLGITORE AUTOMATICO 15M
3GX2.5MM² CON PRESA SCHUKO
LUNGHEZZA CAVO IN INGRESSO 1,20M

15m x 3G2.5mm² ⚡ 1600W
— 230V AC — 3200W

STAFFA A MURO ORIENTABILE A 360°



LIMITATORE DI RIENTRO



SISTEMA DI BLOCCAGGIO

AVVOLGITORE AUTOMATICO





LAMPADE PER CONTROLLO COLORE



LAMPADE PER CONTROLLO COLORE SETTORE CARROZZERIA



FG 234 ~~105,00€~~ **59,00€**

LAMPADA DA TESTA A DOPPIO LED
AD ELEVATO INDICE DI RESA CROMATICA
(CRI 96+) - 3 COLORI
SENSORE ON/OFF CONTACTLESS



COB LED - cri 96+
3 COLORI

2700K 4500K 6500K

NEW



SENSORE ON/OFF
CONTACTLESS



4 LIVELLI DI INCLINAZIONE



CE

NEW



FG 235 ~~135,00€~~ **79,00€**

LAMPADA LED AD ELEVATO
INDICE DI RESA CROMATICA
(CRI 96+) - 3 COLORI



COB LED - cri 96+
3 COLORI

2700K 4500K 6500K

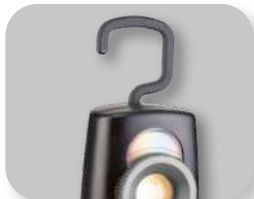

GANCIO ESTRAIBILE



LENTE SOSTITUIBILE



BASE MAGNETICA
+ SUPER MAGNETE SUL RETRO

CE

BASE DI RICARICA DA TAVOLO
CON PRESA USB + CAVO MICRO USB
DA 1 METRO IN DOTAZIONE



NEW



FG 236

~~335,00€~~ **199,00€**

FARO LED RICARICABILE PER CONTROLLO COLORE AD ALTO INDICE DI RESA CROMATICA (CRI 96+)
- 5 COLORI- 3 INTENSITA' 500 - 1000 - 2000 LUMEN



**LED - cri 96+
5 COLORI**

2700K 3500K 4500K 5500K 6500K



**ACCESSORIO TREPPIEDI
NON INCLUSO**



PANNELLO DI CONTROLLO



**CARICABATTERIE A SGANCIO
RAPIDO CON CAVO DA 5M**



NEW



FG 236/SU

~~100,00€~~ **59,00€**

TREPPIEDI PER FARO LED FG 236

PESO NETTO: 1.098 gr

ALTEZZA: 476 MM (CHIUSO) - 1440 MM (APERTO)

NUMERO DI ESTENSIONI DEI PIEDI: 3

MASSIMO CARICO: 2 KG



LA VERSATILITA' CONTA

Con il Sistema portautensili Fasano Tools componibile ed impilabile, disponi i portautensili assecondando le tue necessità. Adatto per ogni utilizzo, il nostro Kit di 4 valigie in ABS consente di lavorare in velocità, perché trovi tutto ciò di cui hai bisogno esattamente dove dovrebbe essere!



MANIGLIONE
A SCOMPARSA
PER FACILITARNE
IL TRASPORTO



PREDISPOSIZIONE
PER LUCCHETTO
DI CHIUSURA



SISTEMA
DI CHIUSURA
RINFORZATO



PORTA ETICHETTE



ORGANIZER VERSATILE

Il sistema di valigie portautensili Fasano Tools, presenta un design versatile. Predisponi come desideri la minuteria, gli accessori ed i piccoli utensili all'interno delle cassetine!

PORTATILE

COMPONIBILE

SICURA E DUREVOLE

SISTEMA DI
BLOCCAGGIO
ANTERIORE



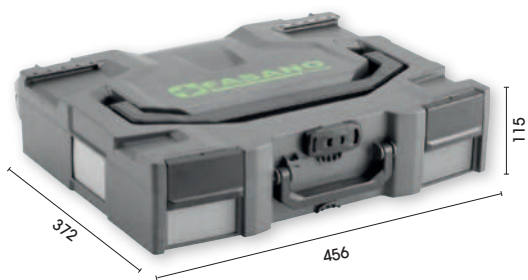

FG 1425

~~102,00€~~ **54,00€**

VALIGIA PORTAUTENSILI IN ABS

DIMENSIONE: 456X372X115MM

PESO: 2.1KG



FG 1426

~~120,00€~~ **64,00€**

VALIGIA PORTAUTENSILI IN ABS

DIMENSIONE: 456X372X155MM

PESO: 2.4KG



FG 1427

~~170,00€~~ **90,00€**

VALIGIA PORTAUTENSILI IN ABS

DIMENSIONE: 456X372X262MM

PESO: 3KG



FG 1434

VALIGIA PORTAUTENSILI IN ABS

DOTATA DI BOX INTERNI

DIMENSIONE: 456X372X115MM

PESO: 3.2KG

~~145,00€~~ **76,50€**

FG 1433

CARRELLO PIEGHEVOLE
RICHIUDIBILE

STRUTTURA IN FERRO

BASE IN ALLUMINIO

PESO: 6KG - PORTATA: 100KG

Ø RUOTE: 180MM

CHIUSO: 70X485X835MM

BASE: 480X350MM

~~190,00€~~ **105,00€**



NEW

1080 mm

490 mm

525 mm

NEW

FG 1438/S4C

KIT 4 VALIGIE IN ABS
IMPILABILI COMPLETO
DI CARRELLO PIEGHEVOLE

~~730,00€~~ **379,00€**



FG 1438/S4B

~~680,00€~~ **359,00€**

KIT 4 VALIGIE IN ABS IMPILABILI CON BASE
D'APPOGGIO DI CUI UNA DOTATA DI BOX INTERNI

PESO: 13.1KG - PORTATA: 100KG

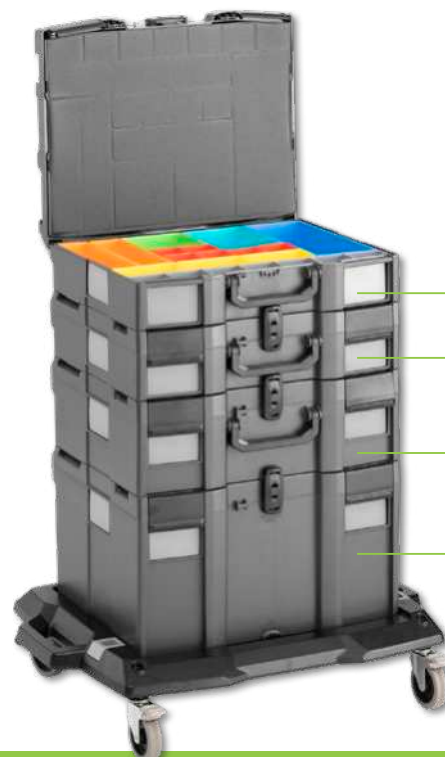

FG 1434

FG 1425

FG 1426

FG 1427



BORSE DA LAVORO

FG 114/L2

~~65,00€~~ **33,90€**

VALIGIA PORTA UTENSILI IN ABS

- 2 SCOMPARTI SOVRAPPONIBILI E SEPARABILI
- FINESTRE ANTERIORI TRASPARENTI
- MANIGLIA ERGONOMICA ORIENTABILE E REGOLABILE



FG 114/L3

~~110,00€~~ **52,50€**

CASSETTA PORTA UTENSILI A 3 RIPIANI

NEW



FG 1445

BOX PORTAMINUTERIE DOTATO DI 8 CONTENITORI ASPORTABILI E DIVISORI REGOLABILI

DIMENSIONE: 385X320X60MM

~~45,00€~~ **23,90€**



FG 1440

~~60,00€~~ **29,90€**

BOX PORTAMINUTERIE DOTATO DI 12 CONTENITORI ASPORTABILI



NEW

FG 109/L3

~~280,00€~~ **149,00€**

CARRELLO PORTA OGGETTI PIEGHEVOLE

PESO: 11KG
PORTATA: 300KG



SISTEMA DI SBLOCCAGGIO

FG 111/AS55

~~616,50€~~ **219,00€**

CASSETTA PORTA-UTENSILI FG 111/C CON 5
SCOMPARTI CON ASSORTIMENTO 55 UTENSILI



PER IL CONTENUTO CONSULTARE
PAGINA 297 DEL CATALOGO GENERALE

FG 111/AS104

~~835,80€~~ **299,00€**

CASSETTA PORTA-UTENSILI FG 111/C CON 5
SCOMPARTI CON ASSORTIMENTO 104 UTENSILI



PER IL CONTENUTO CONSULTARE
PAGINA 297 DEL CATALOGO GENERALE

FG 111/A

~~60,80€~~ **32,90€**

CASSETTA PORTA-UTENSILI A 3 SCOMPARTI

- PREDISPOSIZIONE PER LUCCHETTO
- DIVISORIO SCOMPARTO SUPERIORE
- STRUTTURA IN LAMIERA



CASSETTA PORTA-UTENSILI A 5 SCOMPARTI

- PREDISPOSIZIONE PER LUCCHETTO
- DIVISORIO SCOMPARTO SUPERIORE
- STRUTTURA IN LAMIERA



CODICE	DIMENSIONE	LISTINO	€/PROMO
FG 111/B	430x200x200mm	72,00	39,90
FG 111/C	530x200x200mm	85,00	49,90



BORSE DA LAVORO

FG 115/A

~~250,00€~~ **132,00€**

VALIGIA PORTA-UTENSILI IN POLIPROPILENE - MOD. BASIC

- SERRATURA CENTRALE CON CHIAVE
- SISTEMA PORTA UTENSILI AD ELASTICO
- DOTATA DI PIEDI DI APPOGGIO
- FONDO TERMOFORMATO PORTA OGGETTI
- 2 BOX IN PLASTICA PER MINUTERIA

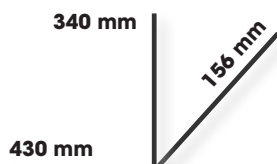

FG 117/A

~~420,00€~~ **219,00€**

VALIGIA PORTA-UTENSILI IN ABS TERMOFORMATO

- 2 SERRATURE LATERALI CON CHIAVE
- SISTEMA PORTA UTENSILI A TASCHE
- DOTATA DI PIEDI DDI APPOGGIO
- FONDO TERMOFORMATO
- SISTEMA TROLLEY INTEGRATO

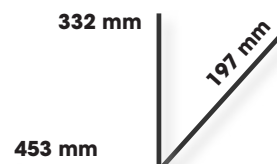

FG 118/AS56

~~749,90€~~ **399,00€**

ASSORTIMENTO 56 UTENSILI PER ELETTROTECNICA



FG 22E/2.5x75	GIRAVITE ISOLATO A TAGLIO 2.5x75 mm
FG 22E/3x100	GIRAVITE ISOLATO A TAGLIO 3x100 mm
FG 22E/4x100	GIRAVITE ISOLATO A TAGLIO 4x100 mm
FG 22E/5.5x125	GIRAVITE ISOLATO A TAGLIO 5.5x125 mm
FG 22E/6.5x150	GIRAVITE ISOLATO A TAGLIO 6.5x150 mm
FG 22E/PH0x60	GIRAVITE ISOLATO A CROCE PH0x60
FG 22E/PH1x80	GIRAVITE ISOLATO A CROCE PH1x80
FG 22E/PH2x100	GIRAVITE ISOLATO A CROCE PH2x100
FG 129/C4	CACCIASPINA 4mm
FG 129/C5	CACCIASPINA 5mm
FG 126/SL1	SCALPELLO LUNGO PER ELETTRICISTI
FG 126/SL2	SCALPELLO LUNGO PER ELETTRICISTI
FG 127/P1	SCALPELLO PIATTO mm26x240L
FG 602/SP9	SET 9 CHIAVI A DOPPIA FORCHETTA 6x7-21x23mm
FG 139/C	SET 10 CHIAVI MASCHIO A L ESAGONALE LUNGO
FG 96/SS36	SALDATORE A STILO 30/60W
FG 22/FX5	GIRAVITE A BUSSOLA 5mm
FG 22/FX6	GIRAVITE A BUSSOLA 6mm
FG 22/FX7	GIRAVITE A BUSSOLA 7mm
FG 22/FX8	GIRAVITE A BUSSOLA 8mm
FG 22/FX10	GIRAVITE A BUSSOLA 10mm
FG 22/FX13	GIRAVITE A BUSSOLA 13mm
FG 58/IS250	PINZA ISOLATA REGOLABILE A CERNIERA
FG 59/IS180	PINZA UNIVERSALE ISOLATA - 180mm
FG 61/IS200	PINZA ISOLATA BECCHI MEZZOTONDI -200mm
FG 63/IS160	TRONCHESE DIAGONALE ISOLATA -160mm
FG 68IS/160	PINZA SPELLAFILI ISOLATA -160mm
FG 49	FORBICE PER ELETTRICISTA
FG 48/IS	CUTTER ISOLATO PER ELETTRICISTI
FG 68/S1	PINZA X CAPICORDA NON-ISOLATI
FG 22/CF250	GIRAVITE CERCAFASE 110-250V
FG 68/CS2	SPELLAFILI 8-28mm
FG 48/L	CUTTER PROFESSIONALE A LAMA LUNGA
FG 136/L35	MAZZUOLA ANTI-RIMBALZO -35gr
FG 132/300	MARTELLO TEDESCO CON MANICO IN RESINA -300gr
FG 81/PT2	PUNTE A TRACCIARE
FG 44/MT5	FLESSOMETRO IN NYLON 5Mx25mm
FG 50/MS	MINISEGHETTO CON LAMA
FG 497/OP2	OLIATORE A PRESSIONE CANNUCCIA OTTONE 80cc

FG 118/AS75

~~564,40€~~ **329,00€**

ASSORTIMENTO 75 UTENSILI PER MANUTENZIONE GENERALE



FG 602/SP9	SET 9 CHIAVI A DOPPIA FORCHETTA 6x7-21x23mm
FG 22/2.5x75	GIRAVITE A TAGLIO 2.5x75mm
FG 22/3.5x100	GIRAVITE A TAGLIO 3.5x100mm
FG 22/4x150	GIRAVITE A TAGLIO 4x150mm
FG 22/6.5x150	GIRAVITE A TAGLIO 6.5x150mm
FG 22/8x150	GIRAVITE A TAGLIO 8x150mm
FG 22/PH0x60	GIRAVITE A CROCE PH0x60
FG 22/PH1x80	GIRAVITE A CROCE PH1x80
FG 22/PH2x150	GIRAVITE A CROCE PH2x150
FG 58/B240	PINZA REGOLABILE CERNIERA 240mm
FG 59SR/180	PINZA UNIVERSALE -180mm
FG 61SR/160	PINZA BECCHI MEZZOTONDI -160mm
FG 63SR/160	TRONCHESE TAGLIANTI DIAGONALI -160mm
FG 49/HE250	FORBICE MULTIUSO MOD. PESANTE 250mm
FG 69/CJ250	PINZA AUTOBLOCCANTE 250mm
FG 35/B4	CHIAVE A RULLINO mm250
FG 132/500	MARTELLO TEDESCO CON MANICO IN RESINA -500gr
FG 49	FORBICE PER ELETTRICISTA
FG 44/MT5	FLESSOMETRO IN NYLON 5Mx25mm
FG 80/8AP	LIMA PIATTA TAGLIO MEZZODOLCE 200mm
FG 81/MS	MATITA X FALEGNAMI
FG 48/L	CUTTER PROFESSIONALE A LAMA LUNGA
FG 79/SP3	SPAZZOLA FILI RIGIDI IN ACCIAIO
FG 139/C	SET 10 CHIAVI MASCHIO A L ESAGONALE LUNGO
FG 85/S31	SET 31 INSERTI + ADATTATORE PORTA INSERTI
FG 94/300	LIVELLA MAGNETICA 300mm
FG 88/P14	GIRAVITE PORTA INSERTI 1/4"
FG 80/8AQ	LIMA QUADRA TAGLIO MEZZODOLCE 200mm

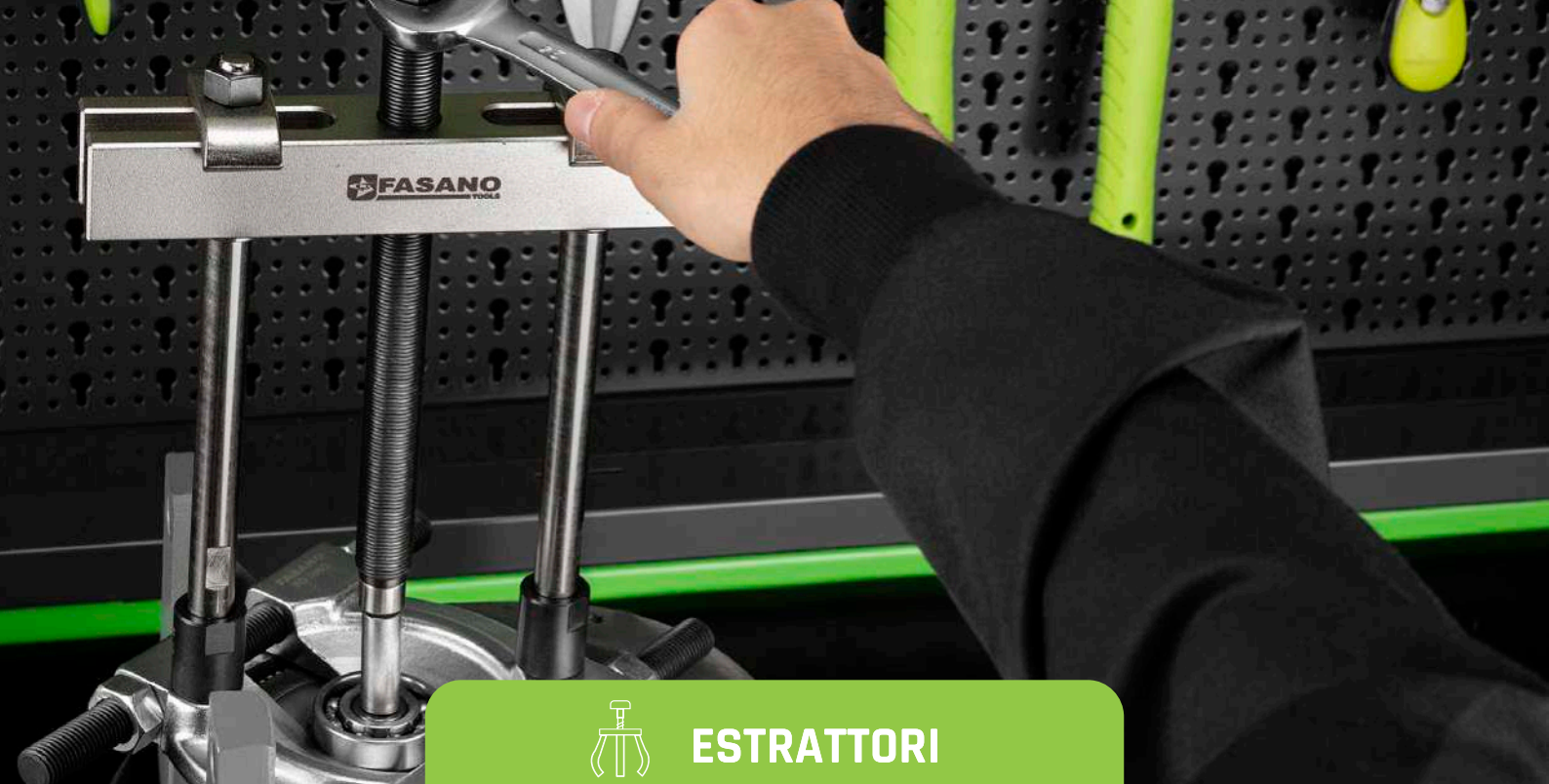

ESTRATTORI



FG 162/S3

~~355,00€~~ 215,00€

SET 3 ESTRATTORI A 2 GRIFFE
27-90MM, 27-135MM, 35-155MM



+



FG 163/S2B

ESTRATTORE A 3 GRIFFE PER PRESA
ESTERNA + GRIFFE PER PRESA INTERNA
- APERTURA MAX PER PRESA ESTERNA: 7-140MM
- APERTURA MAX PER PRESA INTERNA: 50-70MM

~~255,00€~~ 149,00€



ESTRATTORE A 2/3 GRIFFE

- DOTATO DI 3 GRIFFE PER PRESA INTERNA E 3 GRIFFE PER PRESA ESTERNA
- GRIFFE IN ACCIAIO CROMO VANADIO

CODICE	Ø INTERNAL	Ø ESTERNA	LISTINO	€/PROMO
FG 165/IE1	25-100mm	0-75mm	310,00	179,00
FG 165/IE2	45-150mm	40-130mm	740,00	439,00

MASSA BATTENTE

- M12 X 1.5

CODICE	PER	LISTINO	€/PROMO
FG 165/MB1	FG 165/IE1	165,00	99,00
FG 165/MB2	FG 165/IE2	320,00	189,00

FG 165/...

ESTRATTORE AUTOCENTRANTE A 3 GRIFFE

- POSSIBILITÀ DI 4 POSIZIONI DIFFERENTI
- PRESA ESTERNA
- MECCANISMO AUTOCENTRANTE
- GRIFFE CON APERTURA PER CONSENTIRE UNA MIGLIOR PRESA SU BULLONI SPECIALI

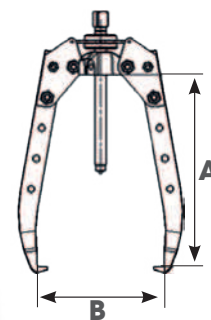

CODICE	A/MM	B/MM	LISTINO	€/PROMO
FG 165/1	120	125	290,00	169,00
FG 165/2	210	220	360,00	209,00
FG 165/3	270	280	540,00	309,00

FG 162/ME

ESTRATTORE A 2 GRIFFE OSCILLANTI

- GRIFFE IN ACCIAIO CROMO VANADIO
- VITE IN ACCIAIO CROMO VANADIO
- A/MM 60MM - H/MM 85MM

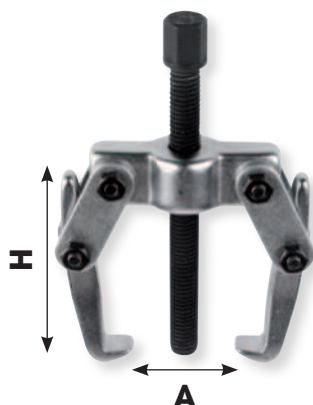

~~32,50€~~ **18,90€**

FG 168EP/S5

SET 5 ESTRATTORI CONICI PER VITI E PRIGIONIERI SPEZZATI

- INSERIMENTO A PERCUSSIONE



~~32,00€~~ **18,90€**

FG 182/S5B

~~460,00€~~ **279,00€**

SET ESPANSORI A SETTORE PER INTERNI CON ACCESSORI

CONTENUTO: FG 182/EG1 - FG 182/ES1
FG 182/ES2 - FG 182/ES3 - FG 182/ES4 - FG 182/ES5

NEW

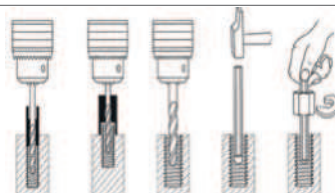

- DOTATO DI GUIDE PER INTERNO ED ESTERNO E PUNTE PER FORARE
- PER VITI/BULLONI CON DIAMETRO 6-16MM

FG 168/S25

~~140,00€~~ **79,00€**

SET ESTRATTORI PER VITI E PRIGIONIERI SPEZZATI

FG 182/S14

~~230,00€~~ **139,00€**

SET ESTRATTORI PER CUSCINETTI CON FALSE SFERE

- ØMM: 5, 6, 8, 9, 11, 12,5





UTENSILI PNEUMATICI



CE



COPPIA
DI SPUNTO



MARTELLO
SINGOLO

1.200

746
Nm

610
Nm

AIRIA 1/2"
136
L/min

9.500
RPM

6:2
Bar

FGA 307

~~250,00€~~ 149,00€

AVVITATORE AD IMPULSI-1/2"



CE



COPPIA
DI SPUNTO



MARTELLO
DOPPIO

1.900

1.085
Nm

746
Nm

AIRIA 1/2"
151
L/min

7.300
RPM

6:2
Bar

FGA 309

~~300,00€~~ 179,00€

AVVITATORE AD IMPULSI-1/2"



CE



COPPIA
DI SPUNTO



MARTELLLO
DOPPIO



FGA 312

~~380,00€~~ **199,00€**

AVVITATORE AD IMPULSI-1/2"



CE



MARTELLLO
DOPPIO



FGA 302

~~240,00€~~ **125,00€**

AVVITATORE AD IMPULSI-1/2"



CE



Coppia
di spunto



Martello
singolo



FGA 307/AN

~~340,00€~~ **179,00€**

AVVITATORE ANGOLARE
AD IMPULSI-1/2"



CE



COPPIA
TORCENTE



FGA 292/B

~~215,00€~~ **129,00€**

CRICCHETTO REVERSIBILE 1/2"



UTENSILI PNEUMATICI

FGA 316/L

~~830,00€~~ **479,00€**

AVVITATORE AD IMPULSI - 3/4"
AD ALBERO LUNGO 6"

FGA 316

~~760,00€~~ **429,00€**

AVVITATORE AD IMPULSI-3/4"



MARTELLINO DOPPIO



FGA 319/L

~~1.250,00€~~ **649,00€**

AVVITATORE AD IMPULSI 1"
AD ALBERO LUNGO 6"

FGA 319

~~1.150,00€~~ **599,00€**

AVVITATORE AD IMPULSI -1"



PIN-LESS



FGA 321/B

~~1.100,00€~~ **579,00€**

AVVITATORE AD IMPULSI 1"
AD ALBERO LUNGO 6"

FGA 321

~~1.050,00€~~ **559,00€**

AVVITATORE AD IMPULSI -1"



MARTELLINO DOPPIO





PIN-LESS



FGA 321/C

AVVITATORE AD IMPULSI 1"
AD ALBERO LUNGO 6"

~~1.220,00€~~ **599,00€**



IDEALE PER UTILIZZI INTENSIVI



FGA 291/C

~~135,00€~~ **79,00€**

MINI-CRICCHETTO
REVERSIBILE PER INSERTI 1/4"



FGA 291/B

~~122,00€~~ **75,00€**

MINI-CRICCHETTO
REVERSIBILE DA 1/4"



FGA 390

PISTOLA DI
GONFIAGGIO

~~140,00€~~ **85,00€**

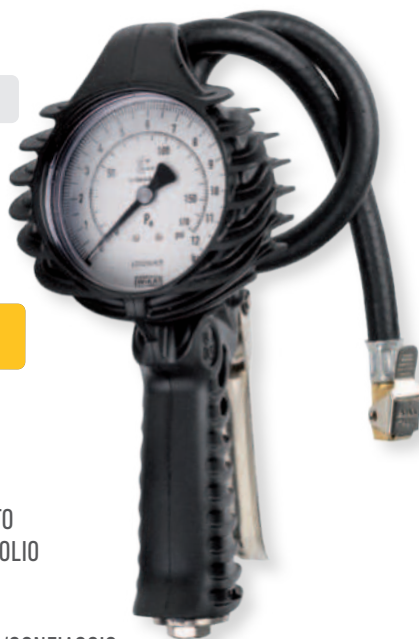

- OMOLOGATA CEE

- CORPO IN ALLUMINIO NICHELATO
- RIVESTIMENTO IN GOMMA ANTIOLIO
- MANOMETRO Ø80 (0-10BAR)
- PROTEZIONE SOVRAPRESSIONI
- LEVA A DUE POSIZIONI SCARICO/GONFIAGGIO
- LUNGHEZZA TUBO: 500MM



FGA 322

LEVIGATRICE
PER PNEUMATICI

~~140,00€~~ **85,00€**



FGA 322/R2: MOLA DI
RICAMBIO 30,00€



UTENSILI PNEUMATICI

FGA 332



TRAPANO REVERSIBILE CON
MANDRINO AUTOSERRANTE 1-10MM



~~145,00€~~ 89,00€

FGA 333



TRAPANO REVERSIBILE CON
MANDRINO AUTOSERRANTE 1-13MM



~~185,00€~~ 109,00€

FGA 333/AC

~~210,00€~~ 125,00€

TRAPANO REVERSIBILE CON
MANDRINO IN ACCIAIO 1-13MM



FGA 332/AN

~~180,00€~~ 109,00€

TRAPANO ANGOLARE
MANDRINO AUTOSERRANTE
1-10MM



FGA 340

~~295,00€~~ 169,00€

- ø orbita: 5.0mm
- platorello 15 fori



FGA 340/B

~~295,00€~~ 169,00€

- ø orbita: 2.5mm
- platorello 15 fori



FGA 342/B

LEVIGATRICE
ROTO-ORBITALE

- ø orbita: 2.5mm
- platorello 3 fori



~~285,00€~~ 169,00€

FGA 337

CE

LEVIGATRICE PNEUMATICA
PER RIMOZIONE RESIDUI GOMMOSI



~~125,00€~~ **75,00€**

FGA 330

CE

SEGHETTO ALTERNATIVO



~~295,00€~~ **159,00€**

FGA 339/B

LEVIGATRICE ANGOLARE
- ø disco: 50mm



~~190,00€~~ **99,00€**

DISCHETTI PER FGA 339/B

CODICE	GRANA	LISTINO	€/PROMO
FGA 339/B-G60	60	9,00	5,40
FGA 339/B-G80	80	10,00	6,00
FGA 339/B-G120	120	12,00	7,20

FGA 346/B

~~220,00€~~ **129,00€**

MICROSMERIGLIATRICE ASSIALE
- Capacità pinza: 3mm



CE

NEW

FGA 335

RIVETTATRICE PNEUMATICA
- 4 testine intercambiabili



~~210,00€~~ **109,00€**

FGA 336

RIVETTATRICE PNEUMATICA
- 4 testine intercambiabili



~~585,00€~~ **359,00€**



UTENSILI PNEUMATICI

FGA 338

SMERIGLIATRICE DIRITTA A PINZA

~~125,00€~~ 75,00€



CE

LAME ROTORE IN KEVLAR

FGA 334

SMERIGLIATRICE DIRITTA A PINZA

~~145,00€~~ 85,00€



CE

FGA 338/B

SMERIGLIATRICE DIRITTA A PINZA A BASSA VELOCITA'

~~160,00€~~ 95,00€



CE

FGA 334/AN115

SMERIGLIATRICE ANGOLARE A PINZA - INCLINAZIONE 115°



CE

FGA 338/AN

SMERIGLIATRICE ANGOLARE A PINZA

~~170,00€~~ 99,00€



CE

FGA 334/AN

SMERIGLIATRICE ANGOLARE A PINZA



CE

FGA 338/L

SMERIGLIATRICE DIRITTA A PINZA AD ALBERO LUNGO

~~165,00€~~ 99,00€



CE

FGA 334/AL

SMERIGLIATRICE DIRITTA A PINZA AD ALBERO LUNGO

~~185,00€~~ 109,00€



CE

FGA 343/N10



LEVIGATRICE A NASTRO
- 10x330mm

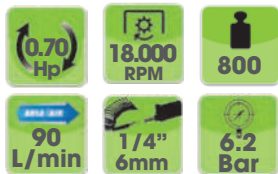

~~220,00€~~ **129,00€**



FGA 342

LEVIGATRICE ORBITALE
- ø orbita: 2mm



~~220,00€~~ **125,00€**



FGA 343/N20

~~285,00€~~ **165,00€**

LEVIGATRICE A NASTRO
- 20X520MM



FILTRO REGOLATORE LUBRIFICATORE

- Portata massima: 4.000 l/min
- Pressione d'uso: 1.5-9.0BAR/21-128PSI
- Temperatura d'utilizzo: 5-60°
- Capacità tazza olio: 75cc
- Capacità tazza aria: 40cc
- Peso: 980gr.



CODICE	ATTACCO	LISTINO	€/PROMO
FGA 385	1/4"	135,00	79,00
FGA 386	3/8"	135,00	79,00
FGA 387	1/2"	135,00	79,00



TUBO IN POLIURETANO RETINATO
STAFFA A MURO ORIENTABILE A 360°

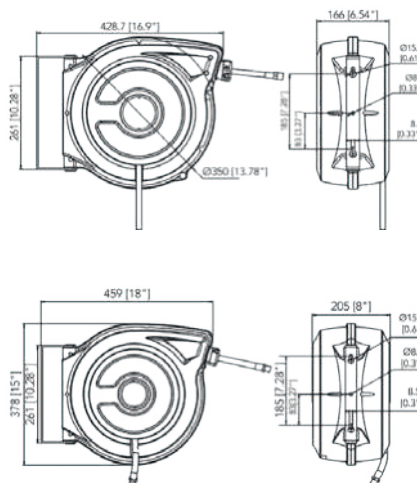

FGA 383/AR15

AVVOLGITUBO AUTOMATICO PER ARIA COMPRESSA -15MT.
- ø tubo interno: 8mm

~~270,00€~~ **139,00€**

FGA 385/AR15

AVVOLGITUBO AUTOMATICO PER ARIA COMPRESSA -15MT.
- ø tubo interno: 10mm

~~360,00€~~ **169,00€**

NEW

Guida di scorrimento automatico



Sistema di bloccaggio a qualsiasi lunghezza

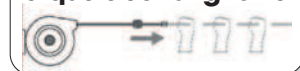

Riavvolgimento a velocità controllata





CARRELLI E BANCHI DA LAVORO

5 VARIANTI COLORE
PER ARREDARE I TUOI SPAZI

RAL 7021

RAL 9016

RAL 6018

RAL 5002

RAL 3001



MADE IN ITALY



SCEGLI TRA I MODELLI A DISPOSIZIONE
QUELLO PIU' ADATTO ALLE TUE NECESSITA'



SIMPLE TOOL TROLLEY



EXTENDED TOOL TROLLEY



KG 500
PORTATA
STATICA

FG 101

CARRELLO PORTA UTENSILI MOD. FG 101

CARATTERISTICHE TECNICHE:

- Guide telescopiche con sistema di aggancio automatico
- 4 ruote in gomma vulcanizzata Ø125mm (2 fisse e 2 girevoli - 1 con freno)
- maniglione laterale in acciaio
- chiusura centralizzata
- cassetti dotati di tappetino interno in gomma

FG101

CODICE	CASSETTI	€/LISTINO	€/PROMO
FG 101V/5G	5 CASSETTI	680,00	359,00
FG 101V/6G	6 CASSETTI	710,00	379,00
FG 101V/7G	7 CASSETTI	750,00	399,00



SISTEMA DI APERTURA A BAIONETTA



MANIGLIONE IN ACCIAIO



TOP IN GOMMA



KG 800
PORTATA
STATICA

FG 102

CARRELLO PORTA UTENSILI MOD. FG 102

CARATTERISTICHE TECNICHE:

- Guide telescopiche con sistema di aggancio automatico
- 4 ruote in gomma vulcanizzata Ø125mm
- maniglione laterale in acciaio
- chiusura centralizzata
- cassetti dotati di tappetino interno in gomma

FG102



CODICE	Casetti	€/Listino	€/PROMO
FG 102V/5G	5 CASSETTI	960,00	469,00
FG 102V/6G	6 CASSETTI	1.030,00	499,00
FG 102V/7G	7 CASSETTI	1.100,00	529,00
FG 102V/8G	8 CASSETTI	1.150,00	559,00



4 RUOTE Ø125 (2 GIREVOLI-2 FISSE)



TOP IN GOMMA



MANIGLIONE IN ACCIAIO

MADE IN ITALY



CARRELLI E BANCHI DA LAVORO



KG 600
PORTATA
STATICA

MADE IN ITALY

FG 100

CARRELLO PORTA UTENSILI MOD. FG 100

CARATTERISTICHE TECNICHE:

- Guide telescopiche con sistema di aggancio automatico
- 4 ruote in gomma vulcanizzata Ø125mm
- ripiano superiore in ABS con maniglione integrato
- chiusura laterale centralizzata
- porta flaconi laterali di serie

FG 100



**SISTEMA DI CHIUSURA
LATERALE**



**RIPIANO SUPERIORE
IN ABS**



**CASSETTO CON
APERTURA COMPLETA**

CODICE					CASSETTI	€/LISTINO	€/PROMO
FG 100V/5T	FG 100B/5T	FG 100R/5T	FG 100D/5T	FG 100W/5T	5 CASSETTI	-1.000,00-	519,00
FG 100V/6T	FG 100B/6T	FG 100R/6T	FG 100D/6T	FG 100W/6T	6 CASSETTI	-1.050,00-	539,00
FG 100V/7T	FG 100B/7T	FG 100R/7T	FG 100D/7T	FG 100W/7T	7 CASSETTI	-1.100,00	559,00



KG 1000
PORTATA
STATICA

MADE IN ITALY

FG 104

CARRELLO PORTA UTENSILI MOD. FG 104

CARATTERISTICHE TECNICHE:

- Guide telescopiche con sistema di aggancio automatico
- 4 ruote in gomma vulcanizzata Ø125mm
- maniglione laterale in acciaio
- chiusura centralizzata
- cassetti dotati di tappetino interno in gomma



**MANIGLIONE IN
ACCIAIO INOX**



**CHIUSURA
CENTRALIZZATA**



CODICE				CASSETTI	€/LISTINO	€/PROMO
FG 104V/6G	FG 104D/6G	FG 104B/6G	FG 104R/6G	6 CASSETTI	-1.250,00-	579,00
FG 104V/7G	FG 104D/7G	FG 104B/7G	FG 104R/7G	7 CASSETTI	-1.350,00-	599,00



FG 105

CARRELLO PORTA UTENSILI MOD. FG 105

CARATTERISTICHE TECNICHE:

- Guide telescopiche con sistema di aggancio automatico
- 4 ruote in gomma vulcanizzata Ø125mm
- maniglione laterale in acciaio
- chiusura centralizzata
- cassetti dotati di tappetino interno in gomma



RIPIANI INTERNI REGOLABILI



ANTINA APRIBILE A 90°, DOTATA DI SERRATURA



MADE IN ITALY



CODICE				CASSETTI	€/LISTINO	€/PROMO
FG 105V/5G	FG 105B/5G	FG 105R/5G	FG 105D/5G	5 CASSETTI	1.300,00	689,00
FG 105V/6G	FG 105B/6G	FG 105R/6G	FG 105D/6G	6 CASSETTI	1.400,00	739,00
FG 105V/7G	FG 105B/7G	FG 105R/7G	FG 105D/7G	7 CASSETTI	1.450,00	769,00



FG 109

CARRELLO PORTA UTENSILI MOD. FG 109 CON APPENDICE LATERALE



RIPIANI IN GOMMA



RIPIANI INTERNI AMOVIBILI E REGOLABILI



MADE IN ITALY



CODICE				CASSETTI	€/LISTINO	€/PROMO
FG 109V/6G	FG 109B/6G	FG 109R/6G	FG 109D/6G	6 CASSETTI	1.600,00	849,00
FG 109V/7G	FG 109B/7G	FG 109R/7G	FG 109D/7G	7 CASSETTI	1.650,00	879,00



CARRELLI E BANCHI DA LAVORO



FG 150

CARRELLO PORTA UTENSILI MOD. FG 150

CARATTERISTICHE TECNICHE:

- Guide telescopiche con sistema di aggancio automatico
- 4 ruote in gomma vulcanizzata Ø125mm (2 fisse e 2 girevoli)
- maniglione in acciaio INOX
- chiusura centralizzata
- cassetti dotati di tappetino interno in gomma
- Portata cassetti modello FG 150: 30Kg



TOP IN GOMMA



MANIGLIONE IN ACCIAIO INOX



CHIUSURA CENTRALIZZATA



KG 800 PORTATA STATICA

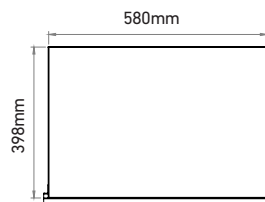

DIMENSIONI CASSETTO FG 150

CODICE	CASSETTI	€/LISTINO	€/PROMO
FG 150D/5G	5 CASSETTI	1.000,00	529,00
FG 150D/6G	6 CASSETTI	1.050,00	549,00
FG 150D/7G	7 CASSETTI	1.100,00	579,00



NEW



2 RIPIANI (SUPERIORE E INFERIORE) PORTA OGGETTI 680X440MM



POSSIBILITA' DI INSERIMENTO MODULI UTENSILERIA

FG 101V/3G

~~500,00€~~ 249,00€

CARRELLO PORTA UTENSILI A 3 CASSETTI MOD. FG 101



NEW



DOTATO DI 16 VASCHETTA AMOVIBILI PORTA MINUTERIE



STRUTTURA LATERALE IN ALLUMINIO E RIPIANI E ACCESSORI IN ABS

FG 108/B

~~250,00€~~ 129,00€

CARRELLO MULTI-SERVIZIO UNIVERSALE PER MINUTERIE E ATTREZZI DA LAVORO



FG 160

CARRELLO PORTA UTENSILI MOD. FG 160

CARATTERISTICHE TECNICHE:

- Guide telescopiche con sistema di aggancio automatico
- 4 ruote in gomma vulcanizzata Ø160mm
- maniglione laterale in acciaio
- chiusura centralizzata
- cassetti dotati di tappetino interno in gomma



- Antina apribile a 90°, dotata di serratura con chiave
- 2 ripiani interni amovibili



- 7 cassetti porta minuteria Profondità: 580x235mm

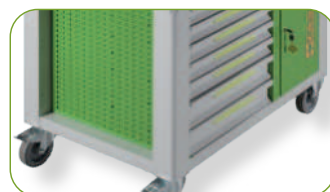

- Larga griglia laterale porta utensili Dimensioni: 665x595mm



KG
2.400

**PORTATA
STATICA**

CODICE	CASSETTI	€/LISTINO	€/PROMO			
FG 160V/14L	FG 160B/14L	FG 160R/14L	FG 160D/14L	14 CASSETTI	3.550,00	1.889,00

JUMBO

MADE IN ITALY

FG 94/MS

**SUPPORTO MAGNETICO
PORTA UTENSILI**



PVC ANTI-GRAFFIO



~~34,00€~~ **16,90€**

FG 94/MI

**SUPPORTO MAGNETICO
PORTA UTENSILI**

DIMENSIONI: 120x94x400mm

KG
9

**PORTATA
MASSIMA**



~~52,00€~~ **22,90€**



FG 94/R

PORTA MINUTERIE MAGNETICO

Dimensione: 165x245mm

~~20,00€~~ **11,90€**



FG 94/T

PORTA MINUTERIE MAGNETICO

Ø 150mm

~~17,00€~~ **9,90€**



CARRELLI E BANCHI DA LAVORO



NEW

FG 101V/AS106

CARRELLO PORTA UTENSILI A 3 CASSETTI MOD. FG 101 CON ASSORTIMENTO 106 UTENSILI IN MODULI RIGIDI

~~1.301,00€~~ 499,00€



2 RIPIANI (SUPERIORE E INFERIORE) PORTA OGGETTI 680X440MM



POSSIBILITA' DI INSERIMENTO MODULI UTENSILERIA

1°CASSETTO

- FG 102/03G: Modulo 14 chiavi combinate 6 - 19mm
- FG 102/17: Modulo 11 chiavi a bussola da 1/4" 4-14mm + accessori
- FG 102/21E: Modulo chiavi a bussola esagonali 1/2" 8-32mm + accessori



2°CASSETTO

- FG 102/48D: Modulo inserti + portainseri 1/4"
- FG 102/VA1: Modulo porta minuterie
- FG 102/65B: Modulo pinza autobloccante e pinza regolabile a cerniera aperta



3°CASSETTO

- FG 102/45D: Modulo 6 giraviti taglio e croce
- FG 102/45I: Modulo 6 giraviti con impronta Torx
- FG 102/39D: Modulo 3 pinze



 **FASANO**
TOOLS



NEW

FG 101V/AS123

CARRELLO PORTA UTENSILI A 3 CASSETTI MOD. FG 101 CON ASSORTIMENTO 123 UTENSILI IN MODULI RIGIDI

~~1.504,50€~~ **599,00€**



2 RIPIANI (SUPERIORE E INFERIORE) PORTA OGGETTI 680X440MM



POSSIBILITA' DI INSERIMENTO MODULI UTENSILERIA

1°CASSETTO

- **FG 102/03G:** Modulo 14 chiavi combinate 6 - 19mm
- **FG 102/17:** Modulo 11 chiavi a bussola da 1/4" 4-14mm + accessori
- **FG 102/21E:** Modulo chiavi a bussola esagonali 1/2" 8-32mm + accessori



2°CASSETTO

- **FG 102/48G:** Modulo 52 inserti 10mm
- **FG 102/VA1:** Modulo porta minuterie
- **FG 102/65B:** Modulo pinza autobloccante e pinza regolabile a cerniera aperta



3°CASSETTO

- **FG 102/45D:** Modulo 6 giraviti taglio e croce
- **FG 102/45I:** Modulo 6 giraviti con impronta Torx
- **FG 102/39D:** Modulo 3 pinze

- **FG 618/A8 - A10 - A13 - A17 - A19:** Chiavi a T esagonali snodate





CARRELLI E BANCHI DA LAVORO

FG 101V/AS136

**CARRELLO PORTA UTENSILI FG 101
A 6 CASSETTI CON ASSORTIMENTO
136 UTENSILI IN MODULI RIGIDI**

~~1.812,00€~~ **699,00€**

**KG
500** **PORTATA
STATICA**



**SISTEMA DI APERTURA
A BAIONETTA**



**MANIGLIONE IN
ACCIAIO**



TOP IN GOMMA

1°CASSETTO

- **FG 102/03G:** Modulo 14 chiavi combinate 6 - 19mm
- **FG 102/17:** Modulo 11 chiavi a bussola da 1/4" 4-14mm + accessori
- **FG 102/21E:** Modulo chiavi a bussola esagonali 1/2" 8-32mm + accessori

2°CASSETTO

- **FG 102/21TX:** Modulo 44 utensili con impronta Torx
- **FG 102/21H:** Modulo rigido inserti a bussola 1/2" esagonali e XZN
- **FG 102/65B:** Modulo pinza autobloccante e pinza regolabile a cerniera aperta



3°CASSETTO

- **FG 102/45D:** Modulo 6 giraviti taglio e croce
- **FG 102/45I:** Modulo 6 giraviti con impronta Torx
- **FG 102/39D:** Modulo 3 pinze



 **FASANO**
TOOLS



FG 101V/AS182

**CARRELLO PORTA UTENSILI FG 101
A 7 CASSETTI CON ASSORTIMENTO
182 UTENSILI IN MODULI RIGIDI**

~~1.966,00€~~ **799,00€**

**KG
500** **PORTATA
STATICA**



**SISTEMA DI APERTURA
A BAIONETTA**



**MANIGLIONE IN
ACCIAIO**



TOP IN GOMMA

1°CASSETTO

- **FG 102/03G:** Modulo 14 chiavi combinate 6 - 19mm
- **FG 102/17E:** Modulo 65 utensili da 1/4"
- **FG 102/21E:** Modulo chiavi a bussola esagonali 1/2" 8-32mm + accessori



3°CASSETTO

- **FG 102/48G:** Modulo 52 inserti - attacco 10mm
- **FG 102/VA1:** Modulo porta minuterie
- **FG 102/23C:** Modulo 14 utensili rinforzati da 1/2"



2°CASSETTO

- **FG 102/39D:** Modulo 3 pinze
- **FG 102/45I:** Modulo 6 giraviti con impronta Torx
- **FG 102/45D:** Modulo 6 giraviti taglio e croce



4°CASSETTO

- **FG 618/A8, A10, A13, A17, A19:** Chiavi a T esagonali snodate





CARRELLI E BANCHI DA LAVORO



FG 102V/AS155

NEW

**CARRELLO PORTA UTENSILI FG 102
A 6 CASSETTI CON ASSORTIMENTO
155 UTENSILI IN MODULI RIGIDI**

~~2.407,50€~~ **999,00€**

**KG
800** PORTATA
STATICA



**4 RUOTE Ø125
(2 GIREVOLI-2 FISSE)**



TOP IN GOMMA



**MANIGLIONE IN
ACCIAIO**



CODICE

FG 102V/AS155	FG 102B/AS155	FG 102R/AS155	FG 102D/AS155
---------------	---------------	---------------	---------------

1°CASSETTO

- **FG 102/03G:** Modulo 14 chiavi combinate 6 - 19mm
- **FG 102/21B:** Modulo chiavi a bussola esagonali 1/2" 8-32mm + accessori
- **FG 102/17:** Modulo 11 chiavi a bussola da 1/4" 4-14mm + accessori

2°CASSETTO

- **FG 102/21TX:** Modulo 44 utensili TORX
- **FG 102/21H:** Modulo rigido inserti a bussola 1/2" esagonali e XZN
- **FG 102/39XT:** Modulo 3 pinze - serie Industrial



3°CASSETTO

- **FG 102/45F:** Modulo 6 giraviti a croce phillips
- **FG 102/45G:** Modulo 7 giraviti ad intaglio
- **FG 102/45I:** Modulo 6 giraviti TORX

4°CASSETTO

- **FG 618/A8, A10, A13, A17, A19:** Chiavi a T esagonali snodate





FG 100V/AS193

NEW

**CARRELLO PORTA UTENSILI FG 100
A 7 CASSETTI CON ASSORTIMENTO
193 UTENSILI IN MODULI RIGIDI**

~~2.572,00€~~ **1.099,00€**

**KG
800** PORTATA
STATICA



CODICE

FG 100V/AS193 FG 100B/AS193 FG 100R/AS193 FG 100D/AS193 FG 100W/AS193



**SISTEMA DI CHIUSURA
LATERALE**



**RIPIANO SUPERIORE
IN ABS**



**CASSETTO CON
APERTURA COMPLETA**

1°CASSETTO

- FG 102/03G: Modulo 14 chiavi combinate 6 - 19mm
- FG 102/03L: Modulo 6 chiavi combinate
- FG 102/21B: Modulo chiavi a bussola esagonali 1/2" 8-32mm + accessori



2°CASSETTO

- FG 102/17E: Modulo 65 utensili da 1/4"
- FG 102/48G: Modulo 52 inserti - attacco 10mm
- FG 102/45I: Modulo 6 giraviti con impronta Torx



3°CASSETTO

- FG 102/39D: Modulo 3 pinze
- FG 102/42C: Modulo 4 pinze per anelli elastici
- FG 102/39XT: Modulo 3 pinze - serie Industrial



4°CASSETTO

- FG 102/56C: Modulo utensili da percussione
- FG 102/65B: Modulo pinza autobloccante e inza regolabile a cerniera aperta
- FG 102/62B: Modulo lime a taglio mezzodolce





CARRELLI E BANCHI DA LAVORO



FG 100V/AS177

**CARRELLO PORTA UTENSILI FG 100
A 7 CASSETTI CON ASSORTIMENTO
177 UTENSILI IN MODULI RIGIDI**

~~2.492,00€~~ **1.099,00€**

**KG
800** **PORTATA
STATICA**

NEW



**SISTEMA DI CHIUSURA
LATERALE**



**RIPIANO SUPERIORE
IN ABS**



**CASSETTO CON
APERTURA COMPLETA**



NEW

NEW

CODICE

FG 100V/AS177	FG 100B/AS177	FG 100R/AS177	FG 100D/AS177	FG 100W/AS177
---------------	---------------	---------------	---------------	---------------

1°CASSETTO

- **FG 102/03G:** Modulo 14 chiavi combinate 6 - 19mm
- **FG 102/VA1:** Modulo porta minuterie
- **FG 102/21B:** Modulo chiavi a bussola esagonali 1/2" 8-32mm + accessori



2°CASSETTO

- **FG 102/17:** Modulo 11 chiavi a bussola da 1/4" 4-14mm + accessori
- **FG 102/48G:** Modulo inserti corti e lunghi con attacco 10mm
- **FG 102/21TX:** Modulo 44 utensili Torx



3°CASSETTO

- **FG 102/39XT:** Modulo 3 pinze - serie Industrial
- **FG 102/45D:** Modulo 6 giraviti a taglio e a croce
- **FG 102/45I:** Modulo 6 giraviti con impronta Torx



4°CASSETTO

- **FG 102/10C:** Modulo 8 chiavi a T snodate esagonali 7-19mm





FG 100V/AS362

NEW

**CARRELLO PORTA UTENSILI FG 100
A 7 CASSETTI CON ASSORTIMENTO
362 UTENSILI IN MODULI RIGIDI**

~~3.619,00€~~ **1.399,00€**

**KG
800** **PORTATA
STATICA**



CODICE

FG 100V/AS362 FG 100B/AS362 FG 100R/AS362 FG 100D/AS362 FG 100W/AS362



- **FG 102/03G:** Modulo 14 chiavi combinate 6 - 19mm
- **FG 102/03L:** Modulo rigido 6 chiavi combinate
- **FG 102/03E:** Modulo 8 chiavi doppia forchetta
- **FG 102/17E:** Modulo 65 utensili da 1/4"
- **FG 102/19:** Modulo utensili con attacco quadro 3/8"
- **FG 102/21B:** Modulo utensili con attacco quadro 1/2"
- **FG 102/21TX:** Modulo utensili torx con attacco 1/4" e 1/2"
- **FG 102/21H:** Modulo inserti a bussola esagonali e xzn con attacco 1/2"
- **FG 102/21R:** Modulo inserti a bussola ribe con attacco 1/2"

- **FG 102/56C:** Modulo utensili da percussione
- **FG 102/39C:** Modulo 3 pinze con manici rivestiti in bi-materiale
- **FG 102/42C:** Modulo 4 pinze per anelli elastici
- **FG 102/45G:** Modulo 7 giraviti con testa ad intaglio
- **FG 102/45F:** Modulo 6 giraviti con testa a croce phillips
- **FG 102/45I:** Modulo 6 giraviti con impronta Torx
- **FG 102/48G:** Modulo 52 inserti con attacco 10mm + adattatore
- **FG 102/65B:** Modulo pinze autobloccanti
- **FG 102/62B:** Modulo 5 lime con taglio mezzodolce
- **FG 85/531:** SET INSERTI DA 1/4" + ADATTATORE PORTA INSERTI 1/4"x1/4"

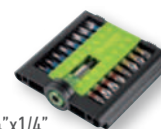



CARRELLI E BANCHI DA LAVORO



FG 102/03G

~~135,00€~~ **79,00€**

MODULO RIGIDO 14 CHIAVI COMBinate

6, 7, 8, 9, 10, 11, 12, 13, 14, 15, 16, 17, 18, 19 mm



FG 102/03H

MODULO RIGIDO 18 CHIAVI COMBinate

6, 7, 8, 10, 11, 12, 13, 14, 16, 17, 18, 19, 21, 22, 24, 27, 30, 32 mm

~~250,00€~~ **149,00€**



FG 102/03L

~~145,00€~~ **89,00€**

MODULO RIGIDO 6 CHIAVI COMBinate

21, 22, 24, 27, 30, 32 mm



FG 102/03E

MODULO RIGIDO 8 CHIAVI A DOPPIA FORCHETTA

6x7-20x22 mm + 139C/FS

~~80,00€~~ **49,00€**



FG 102/03F

MODULO RIGIDO 5 CHIAVI A DOPPIA FORCHETTA

21x23, 24x26, 25x28, 27x29, 30x32 mm

~~92,00€~~ **55,00€**



FG 102/07C

~~92,00€~~ **55,00€**

MODULO 7 CHIAVI DOPPIE POLIGONALI

6x7, 8x9, 10x11, 12x13, 14x15, 16x17, 18x19mm



FG 102/07D

~~135,00€~~ **79,00€**

MODULO 5 CHIAVI DOPPIE POLIGONALI

20x22, 21x23, 24x27, 25x28, 30x32mm



FG 102/08C

~~230,00€~~ **139,00€**

MODULO 11 CHIAVI COMBinate A CRICCO REVERSIBILE

8, 10, 11, 12, 13, 14, 15, 16, 17, 18, 19mm

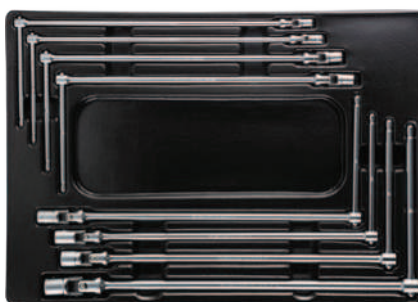

FG 102/10C

MODULO 8 CHIAVI A T SNODATE ESAGONALI

7, 8, 10, 11, 13, 14, 17, 19 mm

~~330,00€~~ **199,00€**



FG 102/13C

~~175,00€~~ **105,00€**

MODULO 10 CHIAVI A PIPA ESAGONALI-POLIGONALI

6,7,8,10,11,12,13,14, 17,19mm



FG 102/17

MODULO 18 UTENSILI DA 1/4"

4-14mm

~~125,00€~~ **75,00€**



FG 102/17E

MODULO 65 UTENSILI DA 1/4"

~~265,00€~~ **159,00€**



FG 102/19

MODULO 18 UTENSILI DA 3/8"
8-23mm ESAGONALI

~~200,00€~~ **119,00€**



FG 102/19B

MODULO 18 UTENSILI DA 3/8"
8-23mm POLIGONALI

~~180,00€~~ **109,00€**



FG 102/21B

MODULO 25 UTENSILI DA 1/2"
10-32mm ESAGONALI

~~230,00€~~ **139,00€**

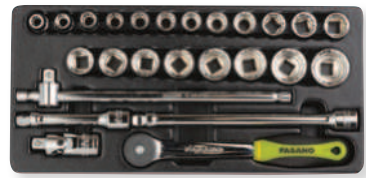

FG 102/21C

MODULO 25 UTENSILI DA 1/2"
10-32mm POLIGONALI

~~230,00€~~ **139,00€**



FG 102/21E

MODULO 16 UTENSILI DA 1/2"
10-32mm ESAGONALI

~~165,00€~~ **99,00€**



FG 102/21D

MODULO 16 UTENSILI DA 1/2"
10-32mm POLIGONALI

~~165,00€~~ **99,00€**



FG 102/21TX

MODULO 44 UTENSILI TORX

~~235,00€~~ **139,00€**



FG 102/21H

**MODULO RIGIDO INSERTI A
BUSSOLA 1/2" ESAGONALI E XZN**

~~200,00€~~ **119,00€**

FG 102/25

**MODULO
9 UTENSILI DA 3/4"**
34-50mm ESAGONALI

~~395,00€~~
219,00€



FG 102/25B

**MODULO
9 UTENSILI DA 3/4"**
34-50mm POLIGONALI

~~395,00€~~
219,00€



FG 102/21R

MODULO INSERTI A BUSSOLA RIBE
R4-R14, LR4.LR14

~~220,00€~~ **135,00€**



FG 102/23C

MODULO 14 UTENSILI RINFORZATI DA 1/2"
10,11,12,13,14,16,17,18,19,21,22,23,24mm + FG 628/PR125

~~145,50€~~ **79,00€**



FG 102/51H

MODULO 7 CHIAVI A T MASCHIO ESAGONALI
10,11,12,2, 2.5, 3, 4, 5, 6, 8mm

~~130,00€~~ **79,00€**



FG 102/39C

MODULO 3 PINZE SOFT-RUN
FG 59SR/180, FG 61SR/160, FG 63SR/160

~~85,00€~~ **49,00€**



FG 102/39XT

MODULO 3 PINZE SERIE INDUSTRIAL
FG 59/XT180 - FG 61/XT160 - FG 63/XT160

~~95,00€~~ **58,00€**

NEW



FG 102/39D

MODULO 3 PINZE CON MANICI IN PVC
FG 59PV/180, FG 61PV/160, FG 63PV/160

~~70,00€~~ **42,00€**



CARRELLI E BANCHI DA LAVORO



FG 102/41C

~~95,00€~~

55,00€

MODULO 4 PINZE PER ANELLI ELASTICI

Capacità: 8-25mm

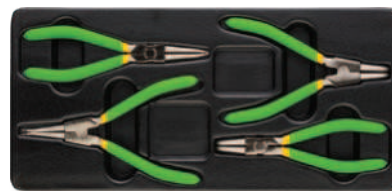

FG 102/42C

~~100,00€~~

59,90€

MODULO 4 PINZE PER ANELLI ELASTICI

Capacità: 19-60mm



FG 102/45D

~~45,00€~~

26,90€

MODULO 6 GIRAVITI AD INTAGLIO E A CROCE PHILLIPS

3x100, 4x125, 5.5x150, 6.5x150, PH1x80, PH2x150



FG 102/45E

~~55,00€~~

32,90€

MODULO 8 GIRAVITI AD INTAGLIO E A CROCE PHILLIPS

3x100, 4x125, 5.5x150, 6.5x150, 6.5x38PH1x80, PH2x150, PH2x38



FG 102/45U

MODULO 12 GIRAVITI AD INTAGLIO E A CROCE PHILLIPS

2.5x60, 3x75, 4x30, 4x100, 5.5x150, 8x150, PH 0x60, PH1x30, PH1x80, PH2x100, PH3x150

~~90,00€~~

55,00€



FG 102/45F

~~52,00€~~

29,90€

MODULO 6 GIRAVITI A CROCE PHILLIPS

PH0x60, PH1x150, PH2x100, PH2x150, PH3x150, PH2x38



FG 102/45G

~~50,00€~~

29,90€

MODULO 7 GIRAVITI AD INTAGLIO

2.5x60, 3x100, 3.5x100, 4x125, 5.5x150, 5.5x100, 6.5x150



FG 102/45I

~~62,00€~~

36,90€

MODULO 6 GIRAVITI TORX

TX10, TX15, TX20, TX25, TX27, TX30



FG 102/45L

~~65,00€~~

39,00€

MODULO 6 GIRAVITI TORX CON FORO

RTX10, RTX15, RTX20, RTX25, RTX27, RTX30



FG 102/45T

~~65,00€~~

39,00€

MODULO 5 GIRAVITI A BUSSOLA ESAGONALI

FX6, FX7, FX8, FX10, FX13



FG 102/48D

~~95,00€~~ **49,90€**

MODULO 40 INSERTI DA 1/4"
+ PORTA INSERTI



FG 102/48G

~~120,00€~~ **69,90€**

MODULO 52 INSERTI DA 10MM
+ ADATTATORE PER CRICCHETTO DA 1/2"



FG 102/50F

~~76,00€~~ **45,00€**

MODULO 6 CHIAVI MASCHIO ESAGONALI
2, 2.5, 3, 4, 5, 6mm



FG 102/50G

~~76,00€~~ **45,00€**

MODULO 6 CHIAVI MASCHIO TORX
TX10, TX15, TX20, TX25, TX27, TX30



FG 102/56C

~~120,00€~~ **72,90€**

MODULO UTENSILI DA PERCUSSIONE
FG 132/500, FG 136/40, FG 126/SN1, FG 126/SN3



FG 102/60C

~~45,00€~~ **26,90€**

MODULO UTENSILI PER MANUTENZIONE
FG 50/MS, FG 48/L, FG 497/OP1, FG 44/MT5



FG 102/62B

~~90,00€~~ **55,00€**

MODULO 5 LIME A TAGLIO MEZZODOLCE



FG 102/VA1

~~15,00€~~ **8,90€**

MODULO PORTA MINUTERIE



FG 102/65B

~~65,00€~~ **39,00€**

MODULO PINZA AUTOBLOCCANTE
E PINZA REGOLABILE A CERNIERA APERTA



CARRELLI E BANCHI DA LAVORO



FG 102V/AS195

NEW

**CARRELLO PORTA UTENSILI FG 102
A 6 CASSETTI CON ASSORTIMENTO
195 UTENSILI IN MODULI DI GOMMA**

~~2.474,80€~~ **999,00€**

**KG
800** PORTATA
STATICA



CODICE

FG 102D/AS195 FG 102B/AS195 FG 102R/AS195 FG 102V/AS195



**4 RUOTE Ø125
(2 GIREVOLI-2 FISSE)**



TOP IN GOMMA



**MANIGLIONE IN
ACCIAIO**

1°CASSETTO

- **FG 100/03G:** Modulo 14 chiavi combinate 6 - 19mm
- **FG 100/VA1:** Modulo porta minuterie
- **FG 100/03E:** Modulo 8 chiavi a forchetta 6x7-20x22mm + set 9 chiavi maschio esagonali



2°CASSETTO

- **FG 100/17E:** Modulo 65 utensili da 1/4"
- **FG 100/VA4:** Modulo porta minuterie
- **FG 100/21H:** Modulo chiavi a bussola esagonali

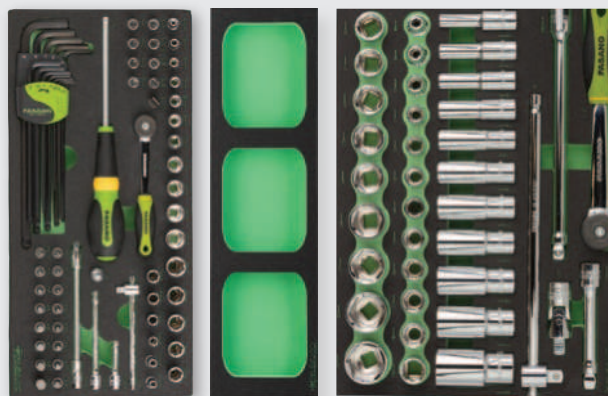

3°CASSETTO

- **FG 100/39XT:** Modulo 3 pinze assortite - serie industrial
- **FG 100/VA1:** Modulo porta minuterie
- **FG 100/48D:** Modulo 40 inserti da 1/4" + porta inserti



4°CASSETTO

- **FG 100/45F:** Modulo 6 giraviti a croce Phillips
- **FG 100/45G:** Modulo 7 giraviti a taglio
- **FG 100/45M:** Modulo 6 giraviti a testa esagonale

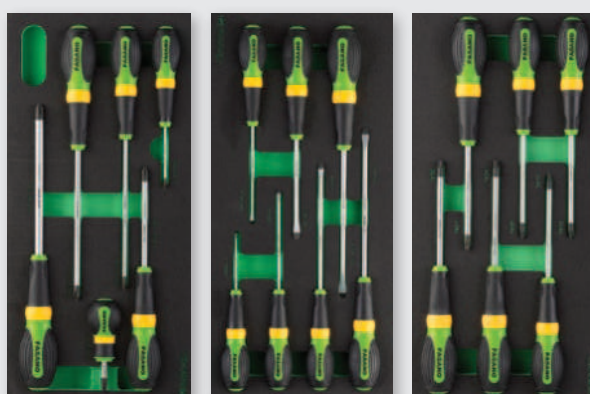



FG 100V/AS224

**CARRELLO PORTA UTENSILI FG 100
A 7 CASSETTI CON ASSORTIMENTO
224 UTENSILI IN MODULI DI GOMMA**

NEW

~~2.794,00€~~ **1.199,00€**

KG 800 PORTATA
STATICA



NEW

NEW

CODICE

FG 100V/AS224	FG 100B/AS224	FG 100R/AS224	FG 100D/AS224	FG 100W/AS224
---------------	---------------	---------------	---------------	---------------



**SISTEMA DI CHIUSURA
LATERALE**



**RIPIANO SUPERIORE
IN ABS**



**CASSETTO CON
APERTURA COMPLETA**

1°CASSETTO

- **FG 100/03G:** Modulo 14 chiavi combinate 6 - 19mm
- **FG 100/17E:** Modulo 65 utensili da 1/4"
- **FG 100/21B:** Modulo chiavi a bussola esagonali 1/2" 8-32mm + accessori

2°CASSETTO

- **FG 100/39XT:** Modulo 3 pinze assortite - serie industrial
- **FG 100/VA1:** Modulo porta minuterie
- **FG 100/21TX:** Modulo 44 utensili TORX



3°CASSETTO

- **FG 100/45I:** Modulo 6 giraviti con impronta Torx
- **FG 100/45D:** Modulo 6 giraviti a taglio e croce
- **FG 100/48G:** Modulo inserti corti e lunghi con attacco 10mm

4°CASSETTO

- **FG 100/10C:** Modulo 8 chiavi a T snodate 7-19mm

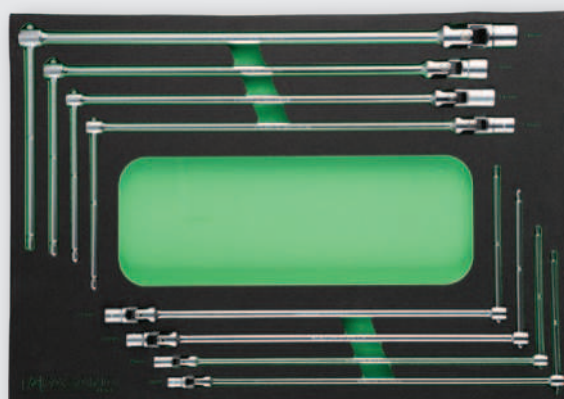



CARRELLI E BANCHI DA LAVORO

NEW

FG 150R/AS167

**CARRELLO PORTA UTENSILI
A 7 CASSETTI CON ASSORTIMENTO
167 UTENSILI IN MODULI DI GOMMA**

~~2.938,00€~~ **1.299,00€**

1°CASSETTO

- FG 100/03G: Modulo 14 chiavi combinate 6 - 19mm
- FG 100/VA1: Modulo di riempimento con vani porta minuteria
- FG 100/03E: Modulo 8 chiavi a forchetta 6x7-20x22mm
+ set 9 chiavi maschio esagonali



3°CASSETTO

- FG 100/81F: Modulo inserti a bussola da 1/2" esagonali e XZN
- FG 100/42C: Modulo 4 pinze per anelli elastici 19-60mm
- FG 100/65B: Modulo pinze autobloccanti e a cerniera



5°CASSETTO

- FG 100/10C: Modulo 8 chiavi a T snodate 7-19mm

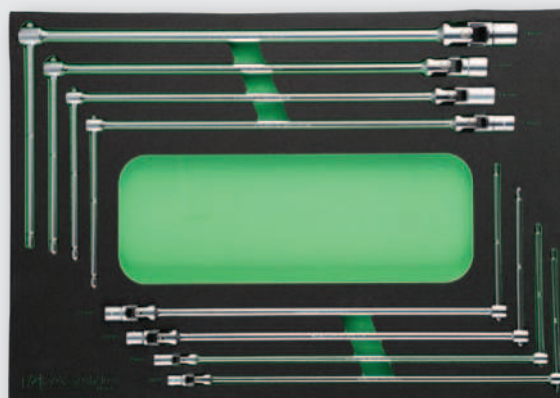

CODICE

FG 150R/AS167 FG 150D/AS167

**KG
800** PORTATA
STATICA

2°CASSETTO

- FG 100/17: Modulo 11 chiavi a bussola da 1/4" esagonali + accessori
- FG 100/21TX: Modulo 44 utensili con impronta TORX
- FG 100/21B: Modulo chiavi a bussola esagonali 1/2" 8-32mm + accessori

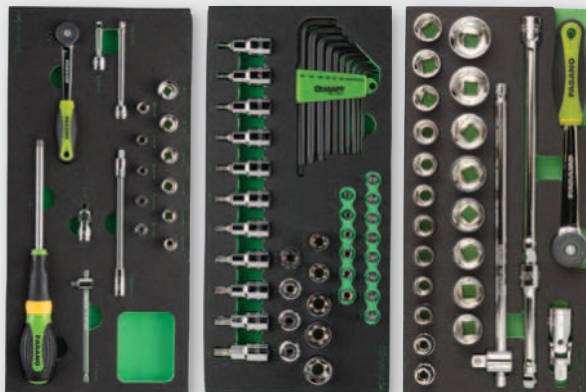

4°CASSETTO

- FG 100/39XT: Modulo 3 pinze assortite - serie industrial
- FG 100/VA1: Modulo di riempimento con vani porta minuteria
- FG 100/45D: Modulo 6 giraviti ad intaglio e a croce phillips





FG 100V/AS214

NEW

**CARRELLO PORTA UTENSILI FG 100
7 CASSETTI CON ASSORTIMENTO
214 UTENSILI IN MODULI IN GOMMA**

~~3.361,00€~~ **1.399,00€**

KG 800 **PORTATA STATICA**

1° CASSETTO

- **FG 100/03G:** Modulo 14 chiavi combinate 6 - 19mm
- **FG 100/VA1:** Modulo di riempimento con vani porta minuteria
- **FG 100/03L:** Modulo 6 chiavi combinate



NEW

NEW

CODICE

FG 100V/AS214	FG 100B/AS214	FG 100R/AS214	FG 100D/AS214	FG 100W/AS214
---------------	---------------	---------------	---------------	---------------

2° CASSETTO

- **FG 100/17E:** Modulo 65 utensili da 1/4"
- **FG 100/21TX:** Modulo 44 utensili con impronta Torx
- **FG 100/21B:** Modulo chiavi a bussola esagonali 1/2" 8-32mm + accessori



3° CASSETTO

- **FG 100/81F:** Modulo inserti a bussola da 1/2" esagonali e XZN
- **FG 100/65B:** Modulo pinze autobloccanti
- **FG 100/42C:** Modulo 4 pinze per anelli elastici 19-60mm



4° CASSETTO

- **FG 100/39XT:** Modulo 3 pinze assortite - serie industrial
- **FG 100/45D:** Modulo 6 giraviti ad intaglio e a croce phillips
- **FG 100/45I:** Modulo 6 giraviti con impronta TORX

5° CASSETTO

- **FG 100/10D:** Modulo 12 chiavi a T snodate

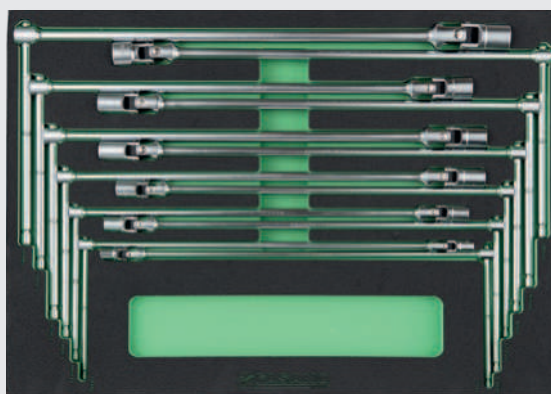



CARRELLI E BANCHI DA LAVORO



FG 100V/AS263

NEW

**CARRELLO PORTA UTENSILI FG 100
7 CASSETTI CON ASSORTIMENTO
263 UTENSILI IN MODULI IN GOMMA**

~~3.314,00€~~ **1.399,00€**

**KG
800** PORTATA
STATICA

1°CASSETTO

- **FG 100/03G:** Modulo 14 chiavi combinate 6 - 19mm
- **FG 100/03L:** Modulo 6 chiavi combinate
- **FG 100/03E:** Modulo 8 chiavi doppia forchetta



NEW

NEW

CODICE

FG 100V/AS263 FG 100B/AS263 FG 100R/AS263 FG 100D/AS263 FG 100W/AS263

2°CASSETTO

- **FG 100/17E:** Modulo 65 utensili da 1/4"
- **FG 100/19:** Modulo chiavi a bussola esagonali
- **FG 100/21B:** Modulo chiavi a bussola esagonali 1/2" 8-32mm + accessori



3°CASSETTO

- **FG 100/21TX:** Modulo utensili con impronta Torx
- **FG 100/48G:** Modulo 52 inserti - attacco 10mm
- **FG 100/23C:** Modulo 20 chiavi a bussola rinforzate

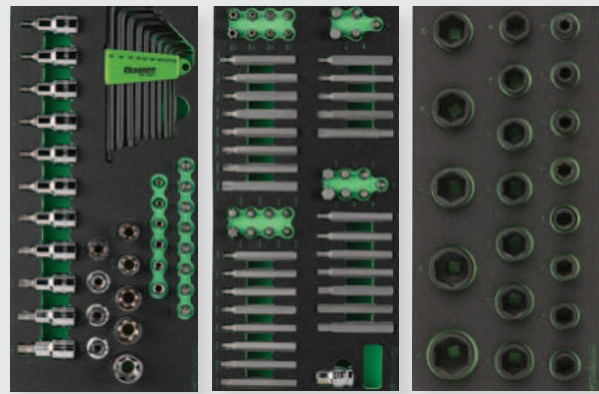

4°CASSETTO

- **FG 100/65B:** Modulo pinze autobloccanti
- **FG 100/39XT:** Modulo 3 pinze assortite - serie industrial
- **FG 100/42C:** Modulo 4 pinze per anelli elastici 19-60mm



5°CASSETTO

- **FG 100/45D:** Modulo 6 giraviti ad intaglio e a croce phillips
- **FG 100/45I:** Modulo 6 giraviti con impronta TORX
- **FG 100/56C:** Modulo utensili da percussione





FG 100V/AS366

**CARRELLO PORTA UTENSILI FG 100
A 7 CASSETTI CON ASSORTIMENTO
366 UTENSILI IN MODULI RIGIDI**

~~3.803,00€~~ **1.499,00€**

**KG
800** **PORTATA
STATICA**

NEW



**SISTEMA DI CHIUSURA
LATERALE**



**RIPIANO SUPERIORE
IN ABS**



**CASSETTO CON
APERTURA COMPLETA**



NEW

NEW

CODICE

FG 100V/AS366 FG 100B/AS366 FG 100R/AS366 FG 100D/AS366 FG 100W/AS366



- FG 102/03G: Modulo 14 chiavi combinate 6 - 19mm
- FG 102/03L: Modulo rigido 6 chiavi combinate
- FG 102/03E: Modulo 8 chiavi doppia forchetta
- FG 102/17E: Modulo 65 utensili da 1/4"
- FG 102/21H: Modulo utensili con attacco quadro 1/2"
- FG 102/VA4: Modulo vuoto porta minuterie
- FG 102/21TX: Modulo utensili torx con attacco 1/4" e 1/2"
- FG 102/81F: Modulo inserti a bussola esagonali e xzn con attacco 1/2"
- FG 102/82B: Modulo inserti a bussola ribe con attacco 1/2"

- FG 102/56C: Modulo utensili da percussione
- FG 102/39XT: Modulo 3 pinze assortite - serie industrial
- FG 102/42C: Modulo 4 pinze per anelli elastici
- FG 102/45G: Modulo 7 giraviti con testa ad intaglio
- FG 102/45F: Modulo 6 giraviti con testa a croce phillips
- FG 102/45I: Modulo 6 giraviti con impronta Torx
- FG 102/50E: Modulo chiavi maschio esagonali e Torx
- FG 102/48G: Modulo 52 inserti con attacco 10mm + adattatore
- FG 85/S31: SET INSERTI DA 1/4" + ADATTATORE PORTA INSERTI 1/4"x1/4"

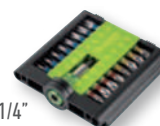



CARRELLI E BANCHI DA LAVORO



**PORTATA
STATICA**

FG 104D/AS242

**CARRELLO PORTA UTENSILI FG 104
A 7 CASSETTI CON ASSORTIMENTO
242 UTENSILI IN MODULI DI GOMMA**

~~3.856,00€~~ **1.499,00€**



CODICE

FG 104V/AS242 FG 104D/AS242 FG 104B/AS242 FG 104R/AS242



**MANIGLIONE IN
ACCIAIO INOX**



**CHIUSURA
CENTRALIZZATA**

1°CASSETTO

- FG 100/03G: Modulo 14 chiavi combinate 6 - 19mm
- FG 100/03L: Modulo 6 chiavi combinate 21 - 32mm
- FG 100/VA4: Modulo di riempimento con vani porta minuteria
- FG 100/21H: Modulo 32 chiavi a bussola esagonali da 1/2" 8-32m + acc.



2°CASSETTO

- FG 100/17E: Modulo 65 utensili da 1/4"
- FG 100/21TX: Modulo 44 utensili con impronta Torx
- FG 100/81F: Modulo inserti a bussola da 1/2" esagonali e XZN
- FG 100/23C: Modulo 20 chiavi a bussola rinforzate da 1/2"

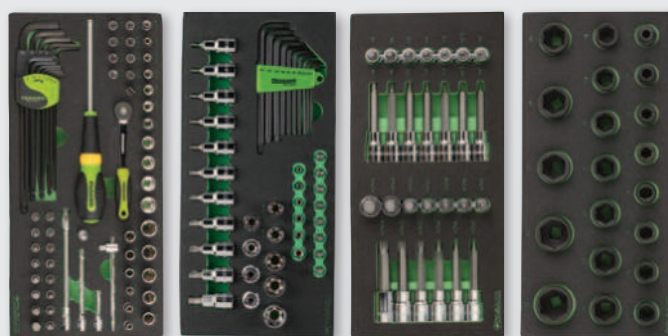

3°CASSETTO

- FG 100/42C: Modulo 4 pinze per anelli elastici 19-60mm
- FG 100/39XT: Modulo 3 pinze assortite - serie industrial
- FG 100/45D: Modulo 6 giraviti ad intaglio e a croce Phillips
- FG 100/45I: Modulo 6 giraviti con impronta Torx



4°CASSETTO

- FG 100/65B: Modulo pinza autobloccante e pinza regolabile a cerniera
- FG 100/10C: Modulo 8 chiavi a T snodate esagonal





FG 160V/AS290

**CARRELLO PORTA UTENSILI A 14 CASSETTI
MOD. FG 160 CON ASSORTIMENTO
290 UTENSILI IN MODULI DI GOMMA**

6.037,80€ 2.999,00€



CODICE

FG 160B/AS290

FG 160R/AS290

FG 160D/AS290

**KG
2.400**

**PORTATA
STATICA**

6 CASSETTI COMPLETI DI UTENSILI

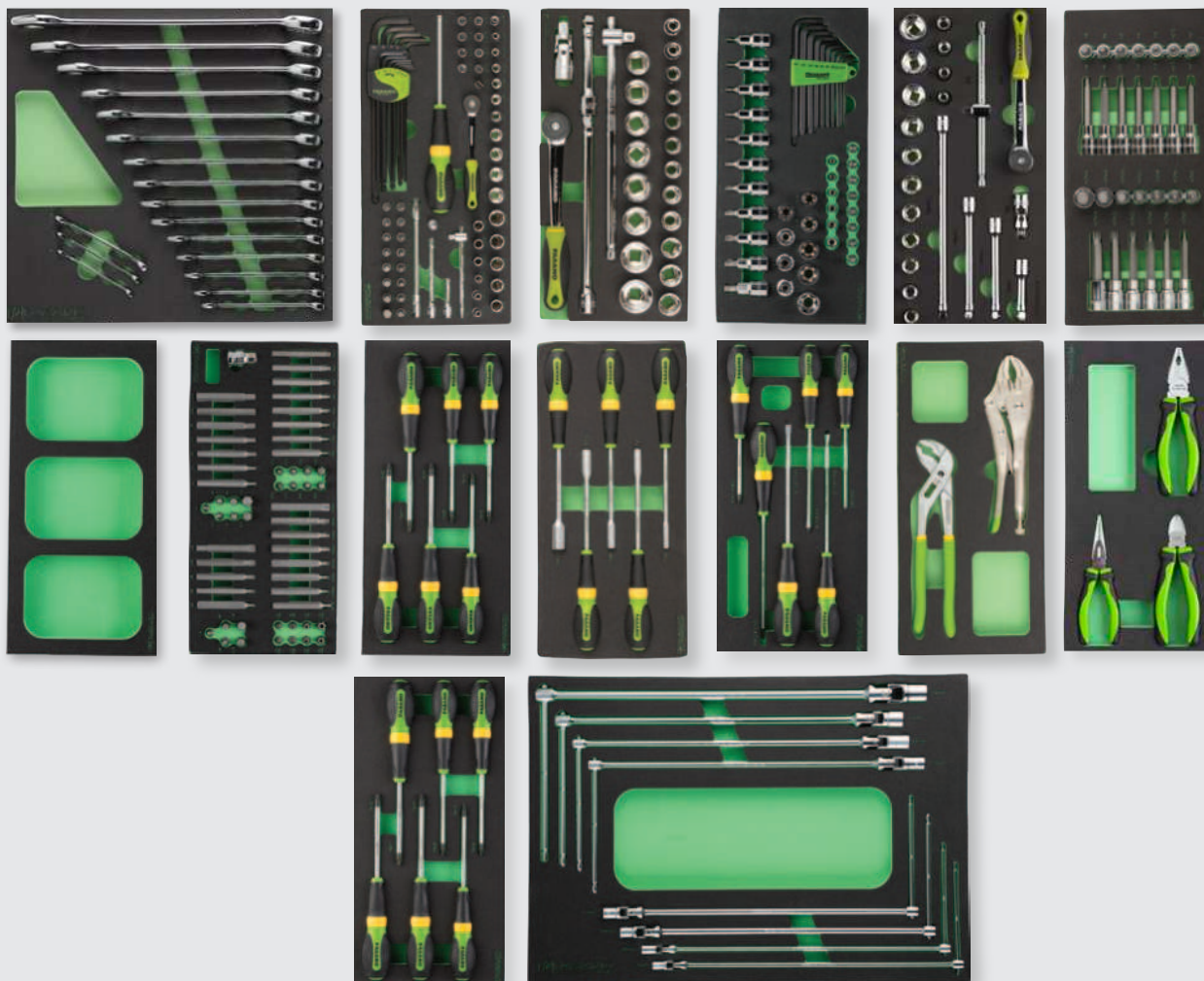

- **FG 100/03H:** Modulo 18 chiavi combinate in mm
- **FG 100/17E:** Modulo 65 utensili da 1/4"
- **FG 100/21B:** Modulo 25 utensili da 1/2"
- **FG 100/21TX:** Modulo 44 utensili con impronta Torx
- **FG 100/19:** Modulo chiavi a bussola esagonali
- **FG 100/81F:** Modulo inserti a bussola da 1/2" esagonali e XZN
- **FG 100/VA1:** Modulo di riempimento con vani porta minuteria
- **FG 100/48G:** Modulo 52 inserti da 10mm

- **FG 100/45I:** Modulo 6 giraviti con impronta TORX
- **FG 100/45T:** Modulo 5 giraviti a bussola esagonali
- **FG 100/45D:** Modulo 6 giraviti taglio e croce
- **FG 100/65B:** Modulo pinza autobloccante e pinza regolabile a cerniera aperta
- **FG 100/39XT:** Modulo 3 pinze assortite - serie industrial
- **FG 100/45M:** Modulo 6 giraviti a testa esagonale
- **FG 100/10C:** Modulo 8 chiavi a T snodate 7-19mm



CARRELLI ASSORTITI SETTORE CARROZZERIA



FG 100V/AS171

~~2.839,00€~~ **1.149,00€**

**CARRELLO PORTA UTENSILI FG 100 6 CASSETTI
CON ASSORTIMENTO 171 UTENSILI IN MODULI IN GOMMA**

NEW

KG 800 **PORTATA STATICA**

1°CASSETTO

- FG 100/03G: Modulo 14 chiavi combinate 6 - 19mm
- FG 100/17E: Modulo utensili con attacco quadro 1/4"
- FG 100/39C: Modulo 3 pinze con manici rivestiti



NEW

NEW

CODICE

FG 100V/AS263 FG 100B/AS263 FG 100R/AS263 FG 100D/AS263 FG 100W/AS263

2°CASSETTO

- FG 100/45I: Modulo 6 giraviti con testa con impronta torx
- FG 100/52F: Modulo 5 raschietti in acciaio con manico in abs
- FG 100/52G: Modulo 5 utensili carrozzeria

3°CASSETTO

- FG 100/52A: Modulo 8 levapioli
- FG 100/52B: Modulo 26 utensili da taglio per carrozzeria
- FG 100/VA4: Modulo vuoto porta minuterie



4°CASSETTO

- FG 100/52C: Modulo 5 utensili per cristalli veicoli
- FG 100/52D: Modulo 10 leve in nylon
- FG 100/52E: Modulo 5 cunei in plastica

5°CASSETTO

- FG 100/52H: Modulo utensili manutenzione per carrozzeria



NEW



FG 104V/AS284

**CARRELLO PORTA UTENSILI FG 104
7 CASSETTI CON ASSORTIMENTO 284
UTENSILI IN MODULI IN GOMMA**

~~4.270,00€~~ **1.599,00€**



CODICE

FG 104V/AS284 FG 104D/AS284 FG 104B/AS284 FG 104R/AS284

KG 1000 **PORTATA STATICA**

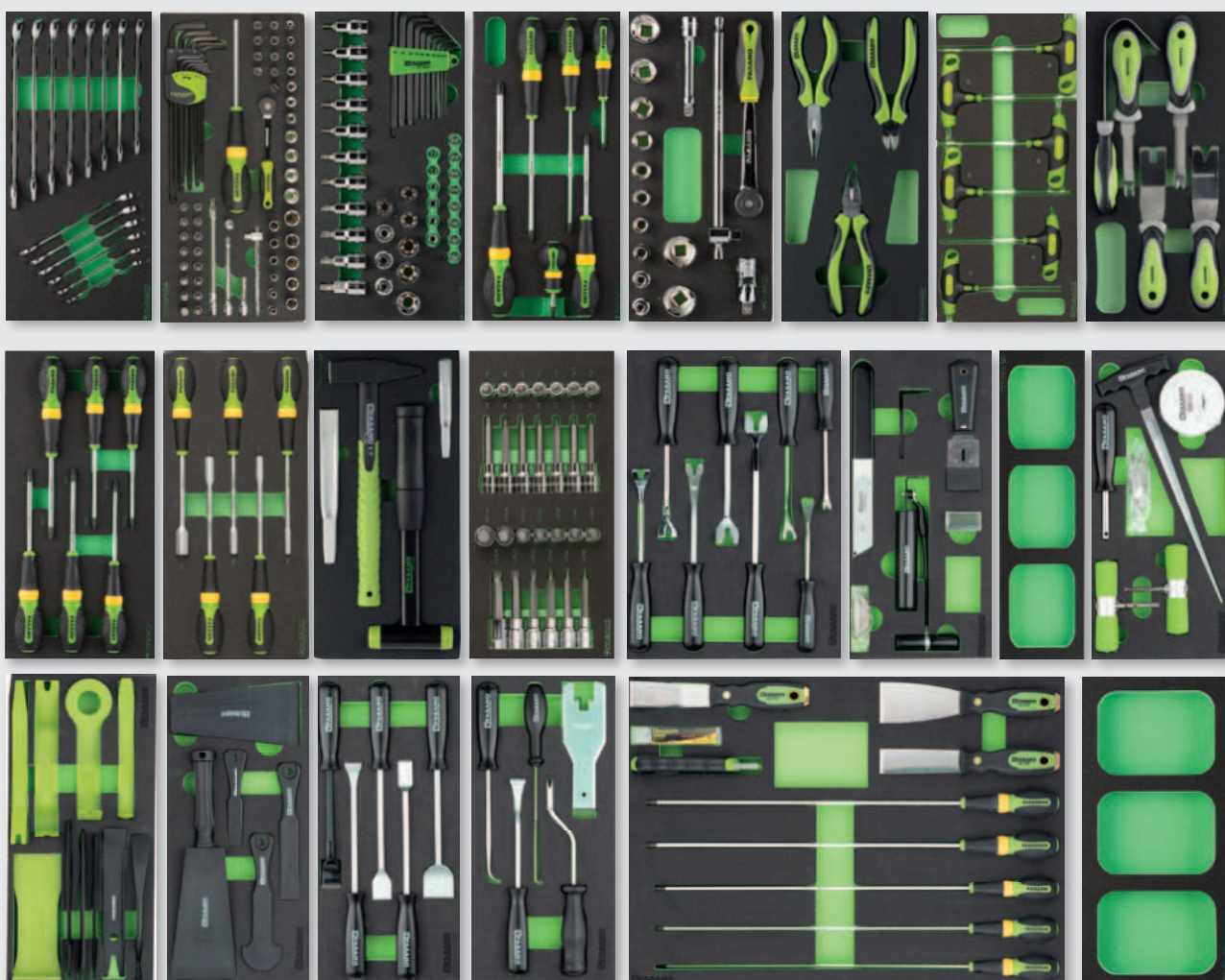

- FG 100/03G: Modulo 14 chiavi combinate
- FG 100/17E: Modulo 65 utensili da 1/4"
- FG 100/21TX: Modulo 44 utensili con impronta Torx
- FG 100/45F: Modulo 6 giraviti con testa a croce phillips
- FG 100/21M: Modulo chiavi a bussola esagonali
- FG 100/39C: modulo 3 pinze con manici rivestiti in bi-materiale
- FG 100/50G: Modulo 6 chiavi maschio torx
- FG 100/68: Modulo 5 levapioli
- FG 100/45I: Modulo 6 giraviti con impronta TORX
- FG 100/45T: Modulo 5 giraviti a bussola esagonali
- FG 100/56C: Modulo utensili da percussione
- FG 100/81F: Modulo inserti a bussola da 1/2" esagonali e XZN

- FG 100/52A: Modulo 8 levapioli
- FG 100/52B: Modulo 26 utensili da taglio per carrozzeria
- FG 100/VA4: Modulo vuoto porta minuterie
- FG 100/52C: Modulo 5 utensili per cristalli veicoli
- FG 100/52D: Modulo 10 leve in nylon
- FG 100/52E: Modulo 5 cunei in plastica
- FG 100/52F: Modulo 5 raschietti in acciaio con manico in abs
- FG 100/52G: Modulo 5 utensili carrozzeria
- FG 100/52H: Modulo utensili manutenzione per carrozzeria
- FG 100/VA1: Modulo vuoto porta minuterie

THE HYBRID REVOLUTION

UTENSILI ESSENZIALI PER AFFRONTARE LE NUOVE SFIDE DEL FUTURO



SPECIALE VEICOLI ELETTRICI

FG 603/S28A

FG 603/S28B

KIT 26 UTENSILI ISOLATI, COMPLETO DI ELMETTO DIELETTICO E GUANTI DIELETTICI 1.000V

IDEALE PER INTERVENTI SU VEICOLI ELETTRICI ED IBRIDI



 1000V
IEC 60900



FG 59/IS200



FG 625E/CR12



FG 61/IS200



FG 625E/PR250



FG 63/IS160



FG 49/E



FG 603/E10,11,12,
13,14,17,19



FG 48/IS



FG 625E/10,11,12,
13,14,17,19



FG 22/CF250



FG 22E/4X100, 5.5X125,
FG22E/PH1X80, PH2X100



CODICE	TAGLIA GUANTI	LISTINO	€/PROMO
FG 603/S28A	TAGLIA 9	1.005,00	499,00
FG 603/S28B	TAGLIA 10	1.005,00	499,00

FG 603/TA1

~~270,80€~~

139,00€

TAPPETO ISOLANTE 1000V

- 1.000x1.000x4mm



**ASSORTIMENTO 56
UTENSILI ISOLATI**



**PORTATA
STATICA
800
KG**

2° CASSETTO

- **FG 100/21-IS: Modulo bussole da 1/2 e accessori isolati**
- Chiavi a bussola esagonali da 1/2" 10-32mm
- Inserti a bussola esagonali corti e lunghi da 1/2" 4-10mm
- Accessori da 1/2"



**SCEGLI TRA 5 VARIANTI DI COLORE
LA TUA PREFERITA!**

Il nuovo carrello porta utensili FG 100 a 6 cassette è ancora più performante e presenta **un assortimento di 56 UTENSILI ISOLATI** in moduli in gomma, **INDISPENSABILI PER LA MANUTENZIONE DI VEICOLI ELETTRICI E IBRIDI.**

FG 100V/AS56

CARRELLO PORTA UTENSILI FG 100 A 6 CASSETTI CON ASSORTIMENTO 56 UTENSILI ISOLATI IN MODULI IN GOMMA

~~3.165,70€~~ **1.299,00€**

1° CASSETTO

- **FG 100/03-IS: Modulo chiavi a forchetta e giraviti isolati**
- Chiavi a forchetta isolate 7-19mm
- Giraviti isolati a taglio 2.5x75mm, 3x100mm, 5.5x125mm, 6.5x150mm, 8x175mm
- Giraviti isolati per viti a croce Phillips PH0x60, PH1x80, PH2x100, PH3x150

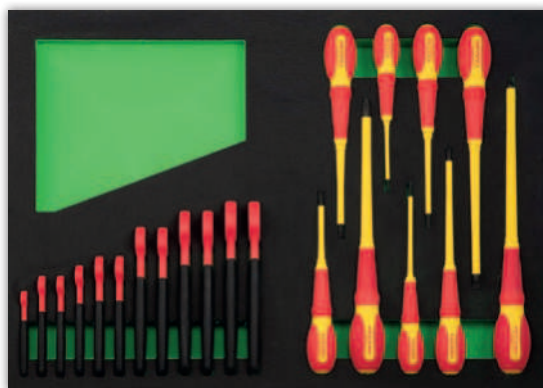

3° CASSETTO

- **FG 100/39-IS: Modulo pinze e utensili da taglio isolati**
- Pinze assortite e tronchese diagonale isolate
- Forbice con manici isolati
- Cutter professionale isolato
- Spellacavi elicoidale



CODICE				
FG 100V/AS56	FG 100B/AS56	FG 100R/AS56	FG 100D/AS56	FG 100W/AS56



CARRELLI E BANCHI DA LAVORO



FG 100/03G

~~150,00€~~ **89,00€**

MODULO 14 CHIAVI COMBinate

6, 7, 8, 9, 10, 11, 12, 13, 14, 15, 16, 17, 18, 19 mm



FG 100/03H

MODULO 18 CHIAVI COMBinate IN mm

FG 600/B6, 7, 8, 10, 11, 12, 13, 14, 16, 17, 18, 19, 21, 22, 24, 27, 30, 32 mm

~~290,00€~~ **169,00€**



FG 100/03L

~~145,00€~~ **89,00€**

MODULO 6 CHIAVI COMBinate

21, 22, 24, 27, 30, 32 mm



FG 100/03E

MODULO 8 CHIAVI A DOPPIA FORCHETTA IMPRONTA ESAGONALE
6x7-20x22 mm + 139C/FS

~~90,00€~~ **55,00€**



FG 100/03F

MODULO 5 CHIAVI A DOPPIA FORCHETTA

21x23, 24x26, 25x28, 27x29, 30x32 mm

~~100,00€~~ **59,00€**



FG 100/07C

~~105,00€~~ **59,00€**

MODULO 7 CHIAVI DOPPIE POLIGONALI

6x7, 8x9, 10x11, 12x13, 14x15, 16x17, 18x19 mm



FG 100/08C

~~240,00€~~ **139,00€**

MODULO 8 CHIAVI COMBinate A CRICCO

8, 10, 11, 12, 13, 14, 15, 16, 17, 18, 19 mm

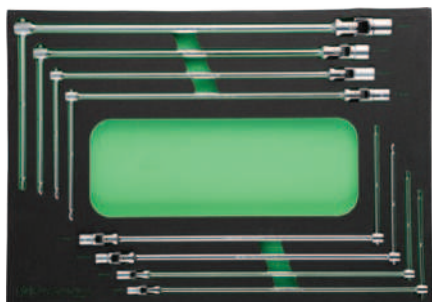

FG 100/10C

MODULO 8 CHIAVI A T SNODATE ESAGONALI

7, 8, 10, 11, 13, 14, 17, 19 mm

~~361,00€~~

219,00€

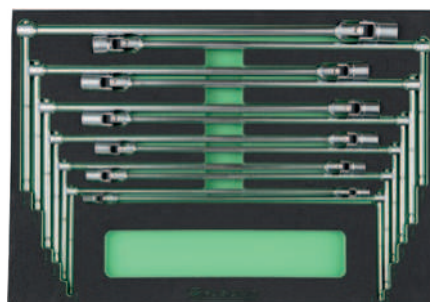

FG 100/10D

MODULO 12 CHIAVI A T SNODATE ESAGONALI

7, 8, 10, 11, 12, 13, 14, 15, 16, 17, 18, 19 mm

~~523,00€~~

319,00€



FG 100/17

~~135,00€~~ **79,00€**

MODULO 18 UTENSILI DA 1/4"

4-14 mm



FG 100/17E

~~285,00€~~ **169,00€**

MODULO 65 UTENSILI DA 1/4"



FG 100/21B

MODULO 25 UTENSILI DA 1/2"
10-32mm ESAGONALI

~~240,00€~~ **139,00€**



FG 100/21C

MODULO 25 UTENSILI DA 1/2"
10-32mm POLIGONALI

~~240,00€~~ **139,00€**



FG 100/21M

MODULO 16 UTENSILI DA 1/2"
10-32mm ESAGONALI

~~159,00€~~ **95,00€**



FG 100/21D

MODULO 16 UTENSILI DA 1/2"
10-32mm POLIGONALI

~~159,00€~~ **95,00€**

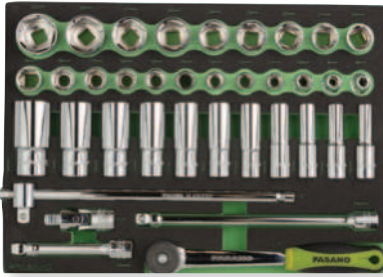

FG 100/21H

MODULO 32 CHIAVI A BUSSOLA ESAGONALI 1/2" + ACCESSORI
BUSSOLE CORTE: 8-32mm
(esclusa 25mm)
BUSSOLE LUNGHE: 10-32mm

~~430,00€~~ **249,00€**

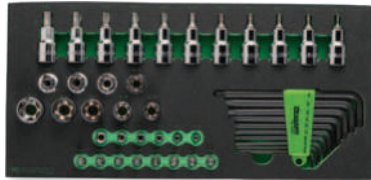

FG 100/21TX

MODULO 44 UTENSILI TORX

~~255,00€~~ **149,00€**

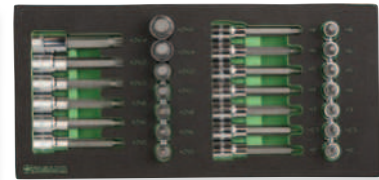

FG 100/81F

MODULO INSERTI A BUSSOLA DA 1/2" ESAGONALI XZN

~~200,00€~~ **119,00€**

FG 100/25

MODULO 9 UTENSILI DA 3/4"
34-50mm ESAGONALI

~~420,00€~~
239,00€



FG 100/25B

MODULO 9 UTENSILI DA 3/4"
34-50mm POLIGONALI

~~420,00€~~
239,00€

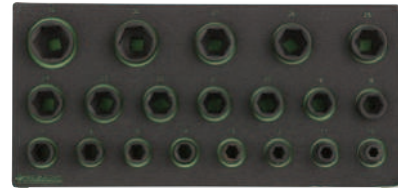

FG 100/23C

MODULO 20 UTENSILI RINFORZATI DA 1/2"

10, 11, 12, 13, 14, 15, 16, 17, 18, 19, 20, 21, 22, 23, 24, 25, 26, 27, 30, 32mm

~~220,00€~~ **129,00€**



FG 100/39C

MODULO 3 PINZE SOFT-RUN
FG 59SR/180, FG 61SR/160, FG 63SR/160

~~95,00€~~ **55,00€**

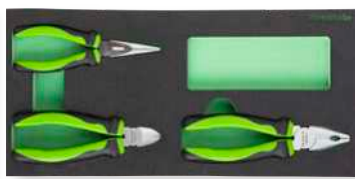

FG 100/39XT

MODULO 3 PINZE ASSORTITE - SERIE INDUSTRIAL
FG 59/XT180 - FG 61/XT160 - FG 63/XT160

~~104,00€~~ **62,90€**



FG 100/65B

MODULO PINZA AUTOBLOCCANTE E PINZA REGOLABILE A CERNIERA APERTA

~~78,00€~~ **48,00€**



FG 100/65C

MODULO PINZE AUTOBLOCCANTI
FG 70/CJ250 - FG 58/A240 - FG 49/HE250

~~125,50€~~ **75,00€**



FG 100/41C

MODULO 4 PINZE PER ANELLI ELASTICI
Capacità: 8-25mm

~~110,00€~~ **65,00€**



FG 100/42C

MODULO 4 PINZE PER ANELLI ELASTICI
Capacità: 19-60mm

~~112,00€~~ **68,00€**



CARRELLI E BANCHI DA LAVORO



FG 100/45D

~~65,00€~~

35,00€

MODULO 6 GIRAVITI AD INTAGLIO E A CROCE PHILLIPS

3x100, 4x125, 5.5x150, 6.5x150, PH1x80, PH2x150



FG 100/45E

~~78,00€~~

45,00€

MODULO 8 GIRAVITI AD INTAGLIO E A CROCE PHILLIPS

3x100, 4x125, 5.5x150, 6.5x150, 6.5x38PH1x80, PH2x150, PH2x38



FG 100/45I

~~80,00€~~

45,00€

MODULO 6 GIRAVITI TORX

TX10, TX15, TX20, TX25, TX27, TX30



FG 100/45T

~~85,00€~~

49,00€

MODULO 5 GIRAVITI A BUSSOLA ESAGONALI

FX6, FX7, FX8, FX10, FX13

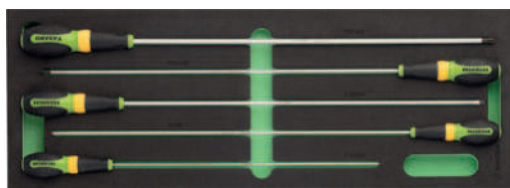

FG 100/45H

~~80,00€~~

45,00€

MODULO 5 GIRAVITI EXTRA LUNGH

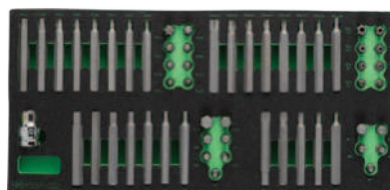

FG 100/48G

~~130,00€~~

79,00€

MODULO 52 INSERTI DA 10MM



FG 100/51H

MODULO 7 CHIAVI MASCHIO ESAGONALI

2, 5, 3, 4, 5, 6, 8mm



~~140,00€~~

85,00€



FG 100/54

MODULO 5 UTENSILI DI MISURAZIONE

~~160,00€~~

98,00€



FG 100/56C

~~130,00€~~

79,90€

MODULO UTENSILI DA PERCUSSIONE

FG 132/500, FG 136/40, FG 126/SN1, FG 126/SN3



FG 100/76C

NEW

~~274,00€~~

159,00€

MODULO TAPPI E CHIAVI FILTRI OLIO

FG 176/F01 - FG 176/RE - FG 175/S15



FG 100/VA1

~~24,00€~~

13,90€

MODULO VUOTO PORTA MINUTERIE



FG 107/A

CARRELLO PORTA ATTREZZI IN LAMIERA D'ACCIAIO

- Dimensione: 380x730x780mm
- 2 ruote fisse e 2 ruote girevoli con freno (Ø 100mm)
- Peso totale: 16.4Kg

~~165,80€~~

89,00€

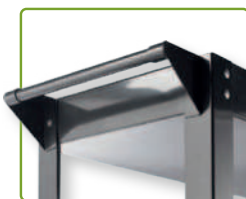

**MANIGLIONE LATERALE
IN LAMIERA D'ACCIAIO**



**4 RUOTE Ø 100MM
(2 GIREVOLI FRENANTI
E 2 FISSE)**



**RIPIANO CON BORDO RIALZATO
(PROFONDITA' 75MM)**



FG 106/A

CARRELLO PORTA ATTREZZI IN LAMIERA D'ACCIAIO

- Dimensione: 350x750x957mm
- Lamiera d'acciaio 1.5mm
- Ruote montate su supporto rotante a piastra con gruppo rotante realizzato con doppia corona di sfere
- 2 ruote fisse, 1 girevole + 1 girevole con freno (Ø80mm)
- Peso totale: 19.5Kg

~~250,80€~~

129,00€



FG 106/B

~~300,80€~~

169,00€

CARRELLO PORTA ATTREZZI IN LAMIERA D'ACCIAIO

- Dimensione: 460x930x885mm
- Lamiera d'acciaio 1.5mm
- Ruote montate su supporto rotante a piastra con gruppo rotante realizzato con doppia corona di sfere
- 2 ruote fisse, 1 girevole + 1 girevole con freno (Ø100mm)
- Peso totale: 22.0Kg

FG 106/C

~~390,80€~~

199,00€

CARRELLO PORTA ATTREZZI IN LAMIERA D'ACCIAIO - MOD. GIGANTE

- Dimensione: 560x1.000x950mm
- Lamiera d'acciaio 2.0mm
- Ruote montate su supporto rotante a piastra con gruppo rotante realizzato con doppia corona di sfere
- 2 ruote fisse, 1 girevole + 1 girevole con freno (Ø125mm)
- Peso totale: 44.0Kg



CARRELLI E BANCHI DA LAVORO

GAMMA FG 128



FG 128/2

BANCO DA LAVORO 2MT SENZA CASSETTI

Peso totale: 59,5Kg
Portata statica: 2000Kg
Dimensioni: 2.000x670x880mm

~~700,00€~~ **349,00€**

NEW

MADE IN ITALY

DISPONIBILE CON DUE CASSETTI IN TRE VARIANTI COLORE



FG 128/D2

BANCO DA LAVORO 2MT DOTATO DI 2 CASSETTI

Peso totale: 74,5Kg
Portata statica: 2000Kg
Dimensioni: 2.000x670x880mm

~~950,00€~~ **479,00€**

NEW

MADE IN ITALY



FG 128/B2

FG 128/R2

GAMMA FG 129

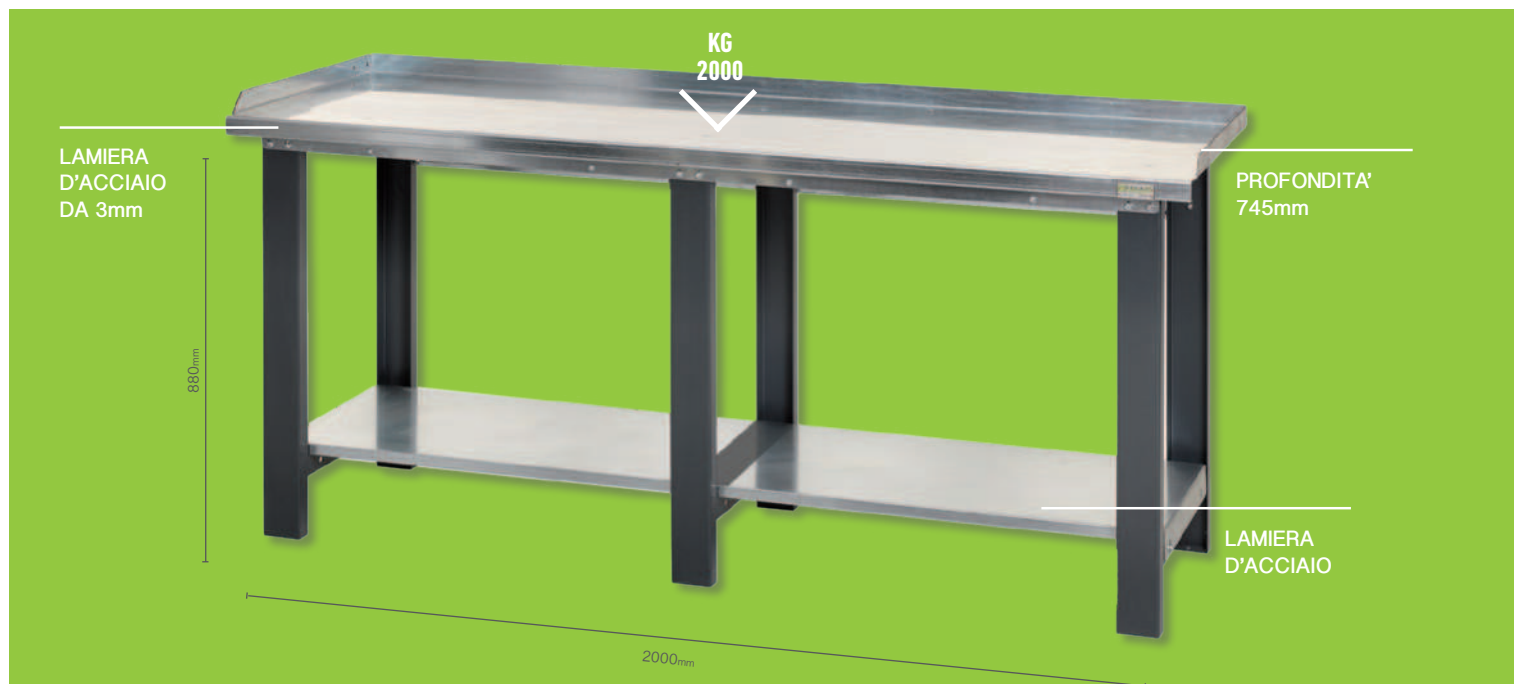

FG 129/2

BANCO DA LAVORO 2MT SENZA CASSETTI

Peso totale: 59,5Kg
Portata statica: 2000Kg
Dimensioni: 2.000x745x880mm

~~850,00€~~ **449,00€**

NEW

MADE IN ITALY

DISPONIBILE CON DUE CASSETTI IN TRE VARIANTI COLORE



FG 129/D2

BANCO DA LAVORO 2MT DOTATO DI 2 CASSETTI

Peso totale: 74,5Kg
Portata statica: 2000Kg
Dimensioni: 2.000x745x880mm

~~1.100,00€~~ **579,00€**



FG 129/B2

FG 129/R2

NEW

MADE IN ITALY



CARRELLI E BANCHI DA LAVORO

BANCO DA LAVORO CON 1 CASSETTIERA A 5 CASSETTI



FG 131/D2

**BANCO DA LAVORO 2.0MT CON RIPIANO
IN ACCIAIO E CASSETTIERA A 5 CASSETTI**

Peso totale: 121.50Kg
Portata statica: 2.000Kg
Dimensioni: 2.000x670x920mm

~~1.700,00€~~ **899,00€**

NEW

MADE IN ITALY

BANCO DA LAVORO CON 2 CASSETTIERE A 5 CASSETTI



FG 132/D2

**BANCO DA LAVORO 2.0MT CON RIPIANO
IN ACCIAIO E 2 CASSETTIERE A 5 CASSETTI**

Peso totale: 156.50Kg
Portata statica: 2.000Kg
Dimensioni: 2.000x670x920mm

~~2.350,00€~~ **1.249,00€**

NEW

MADE IN ITALY



FG 137/D1.5

**BANCO DA LAVORO 1.5MT
CON VASCA DI RACCOLTA
DI COLORE GRIGIO DARK
E RUOTE GIREVOLI**

Peso totale: 90,00Kg
Dimensione: 1.500x745x880mm

~~1.400,00€~~ **739,00€**



FG 137/R1.5



FG 131/B2

RIPIANO MICRO FORATO

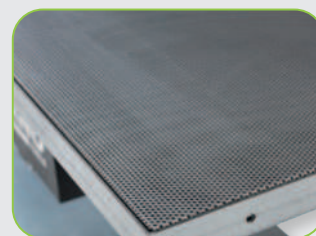

FG 131/A1

**BANCO DA LAVORO 1.0MT
- RIPIANO IN ACCIAIO INOX
E RUOTE GIREVOLI (2 FRENANTI)**

Dimensione: 1.000x750x920 mm

~~1.350,00€~~ **699,00€**



**PARTICOLARMENTE INDICATO
PER LAVORI SU CAMBI AUTOMATICI**

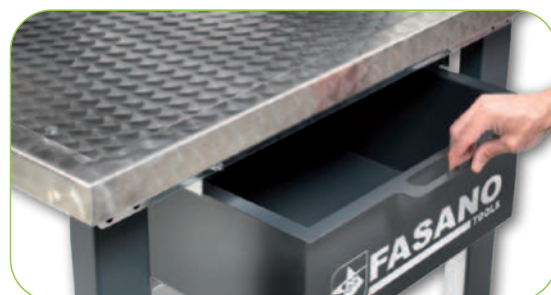

**VASCA DI RACCOLTA ESTRAIBILE DOTATA
DI RUBINETTO DI SPURGO
PORTATA: 30 LITRI**



ARREDAMENTO TECNICO

Il meglio del made in Italy

RAL
6018

RAL
5002

RAL
3001

Personalizza i tuoi spazi di lavoro!

I prodotti **Fasano Tools** sono frutto di un intenso lavoro di ricerca, sviluppo e progettazione interna. La vasta gamma di prodotti che proponiamo è caratterizzata da attenzione e cura per i dettagli, ma anche da stile e design.



MADE IN ITALY



PRESE IN DOTAZIONE
PRESA 220V A 2 POLI
+ 1 PRESA SHUKO A
2 POLI + USB



MODULO DISTRIBUZIONE
OLIO, DOTATO DI
2 PISTOLE DIGITALI
CONTA LITRI



PENSILI DOTATI DI
PISTONI A GAS
PER AGEVOLARE
L'APERTURA/CHIUSURA
DELLO SPORTELLO



VANO PORTA RIFIUTI
MONTATO SU GUIDE
TELESCOPICHE



PIANO DI LAVORO
IN ACCIAIO INOX
E VASCA DI RACCOLTA
ESTRAIBILE



CASSETTI PREDISPOSTI
PER L'INSERIMENTO
DEI MODULI COMPLETI
DI UTENSILI



DIMENSIONI: 2.050X757X2.000mm

MADE IN ITALY

FG 118/C013V

**CONFIGURAZIONE DI ARREDAMENTO
TECNICO DA 2.050MM**

CONFIGURAZIONE COMPOSTA DA:

- FG 118/69V7 (Cassettiera fissa a 7 cassetti)
- FG 118V/40F (Modulo porta carta, dotato di cassetto porta rifiuti)
- FG 118V/69A (Modulo armadietto a 2 antine)
- 02 griglie porta utensili **complete di illuminazione LED**
- 02 prese di corrente composte da 1 presa 220V a 2 poli, 1 presa Schuko a 2 poli, USB

~~5.600,00€~~ **2.849,00€**



FG 118/C013B



FG 118/C013R



DIMENSIONI: 2.050X757X2.000mm

MADE IN ITALY

FG 118/C02V

**CONFIGURAZIONE DI ARREDAMENTO
TECNICO DA 2.050MM**

CONFIGURAZIONE COMPOSTA DA:

- FG 118V/69A (Modulo armadietto a 2 antine)
- FG 118V/7T (Cassettiera mobile a 7 cassetti)
- FG 118V/40F (Modulo porta carta, dotato di cassetto porta rifiuti)
- 02 pensili superiori dotati di pistoni a gas e serratura di chiusura
- 02 griglie porta utensili
- 01 presa di corrente composta da 1 presa 220V a 2 poli, 1 presa Schuko a 2 poli, USB

~~5.840,00€~~ **2.999,00€**



FG 118/C02B



FG 118/C02R



FG 118/C03V

CONFIGURAZIONE DI ARREDAMENTO TECNICO DA 2.550MM

CONFIGURAZIONE COMPOSTA DA:

- FG 118V/69A (Modulo armadietto a 2 antine)
- FG 118V/7T (Cassettiera mobile a 7 cassetti)
- FG 118V/40F (Modulo porta carta, dotato di cassetto porta rifiuti)
- FG 118/AR1V (Armadietto laterale da 500mm)
- 02 pensili superiori dotati di pistoni a gas e serratura di chiusura
- 02 griglie porta utensili
- 01 presa di corrente composta da 1 presa 220V a 2 poli, 1 presa Schuko a 2 poli, USB

~~6.568,00€~~ **3.399,00€**

DIMENSIONI: 2.550X757X2.000mm

MADE IN ITALY



FG 118/C03B



FG 118/C03R



FG 118/C08V

CONFIGURAZIONE DI ARREDAMENTO TECNICO DA 1.220M DOTATA DI PENSILE SUPERIORE E GRIGLIA PORTA UTENSILI

CONFIGURAZIONE COMPOSTA DA:

- FG 118/69V7 (Cassettiera fissa a 7 cassetti)
- FG 118M/40F (Modulo porta carta, dotato di cassetto porta rifiuti)
- Pensile superiore dotato di pistoni a gas e serratura di chiusura
- 01 griglia porta utensili semplice
- 02 prese di corrente composte da 1 presa 220V a 2 poli, 1 presa Schuko a 2 poli cadauna, USB

~~3.778,00€~~ **1.999,00€**

DIMENSIONI: 1.225X757X2.000mm

MADE IN ITALY



FG 118/C08B



FG 118/C08R



FG 118/C020V

**CONFIGURAZIONE DI ARREDAMENTO
TECNICO DA 5.600MM**

~~14.420,00€~~ **7.599,00€**

CONFIGURAZIONE COMPOSTA DA:

- 04 pensili superiori dotati di pistoni a gas
- FG 118V/69A (Modulo armadietto a 2 antine)
- FG 118V/7T (Cassetiera mobile a 7 cassetti)
- FG 118V/40F (Modulo porta carta dotato di cassetto porta rifiuti)
- FG 118V/69E (Modulo porta rifiuti, dotato di contenitori interni in plastica)
- FG 118M/40D (Modulo distribuzione aria compressa)
- FG 118/69V7 (Cassetiera fissa a 7 cassetti)
- FG 118/AR1V (Armadietto laterale da 500mm)
- FG 118/AR2V (Armadietto laterale da 1.000mm a 2 antine)



FG 118/C020B



FG 118/C020R



MODULAR FORMS

FG 116

NEW



RAL 7021

RAL 6018

13 MODULI SINGOLI
per comporre la configurazione ideale
per il tuo spazio di lavoro

CARRELLI



CASSETTIERE



MODULI MULTIFUNZIONE





POSSIBILITA' DI INSERIRE MODULI DI UTENSILERIA ALL'INTERNO DEI CASSETTI



PIANO DI LAVORO IN ACCIAIO ZINCATO DA 2mm

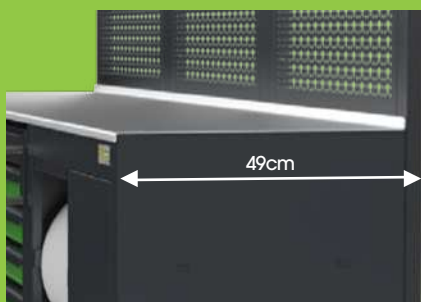

COMPOSIZIONE COMPATTA CON SOLO 49cm DI PROFONDITA'



VANO PORTA RIFIUTI MONTATO SU GUIDE TELESCOPICHE



GRIGLIE PORTA UTENSILI

NUOVO SISTEMA DI ARREDAMENTO TECNICO per l'organizzazione e la personalizzazione del tuo spazio di lavoro

COMPATTEZZA:

49 cm di profondità, ideale per arredare anche gli ambienti meno spaziosi

ROBUSTEZZA:

Spessore del piano di lavoro in acciaio zincato: **2mm**
Spessore struttura in lamiera zincata e verniciata: **1mm**

QUALITÀ:

Struttura per griglie e pensili realizzata con colonne montata sugli stessi moduli per un'elevata resistenza nel tempo

FUNZIONALITÀ:

Cassetti predisposti per l'inserimento dei moduli di utensili Fasano Tools

MADE IN ITALY:

Progettato e realizzato in Italia all'interno dei nostri stabilimenti per garantire cura dei dettagli, stile elegante ed attenzione nella scelta dei materiali

VERSATILITÀ:

Sistema flessibile e modulare, con possibilità di completa personalizzazione oppure scelta di combinazioni predeterminate ampliabili o modificabili nel tempo.



4 TIPOLOGIE DI STRUTTURA BASE

MADE IN ITALY

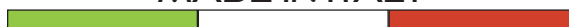



ARREDAMENTO TECNICO

CONFIGURAZIONI FG 116 DA 2.065mm

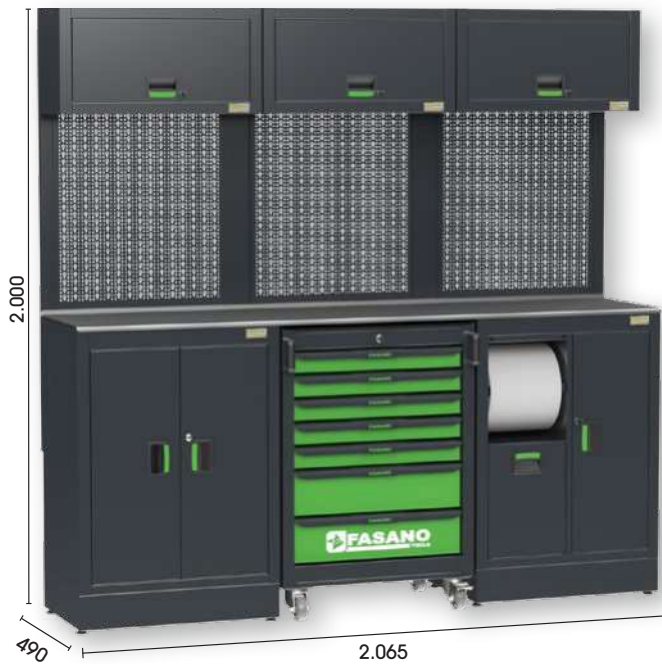

FG 116/C02V

~~4.305,00€~~ **2.149,00€**

CONFIGURAZIONE COMPOSTA DA:

- FG 116V/68A: Modulo armadietto
- FG 116V/7G: Carrello porta utensili
- FG 116V/68B: Armadietto, porta carta e porta rifiuti

CONFIGURAZIONI FG 116 DA 2.065mm + ARMADIO



FG 116/C03V

~~5.025,00€~~ **2.599,00€**

CONFIGURAZIONE COMPOSTA DA:

- FG 116V/68A: Modulo armadietto
- FG 116V/7G: Carrello porta utensili
- FG 116V/68B: Armadietto, porta carta e porta rifiuti
- FG 118/AR1V: Armadio alto - 500x510x2.000mm

CONFIGURAZIONI FG 116 DA 2.065mm

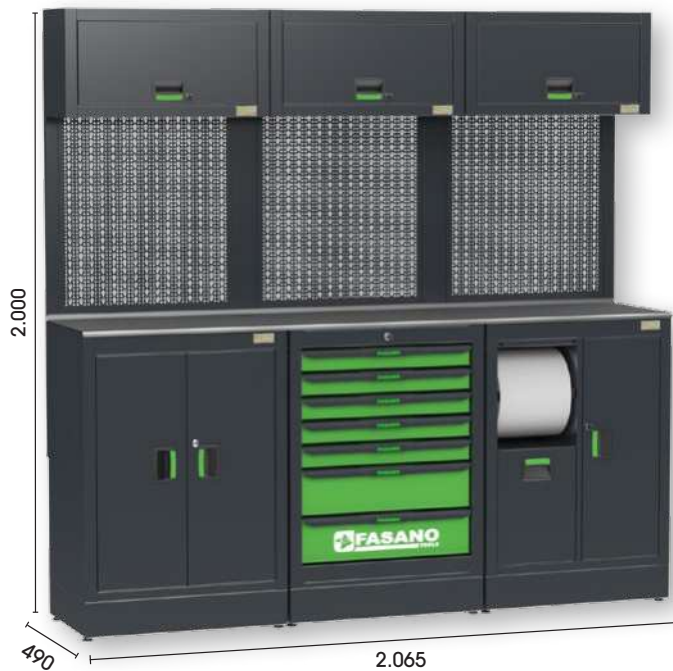

FG 116/C06V

~~4.355,00€~~ **2.199,00€**

CONFIGURAZIONE COMPOSTA DA:

- FG 116V/68A: Modulo armadietto
- FG 116/68V7: Cassettiera fissa a 7 cassetti
- FG 116V/68B: Armadietto, porta carta e porta rifiuti

CONFIGURAZIONI FG 116 DA 2.065mm

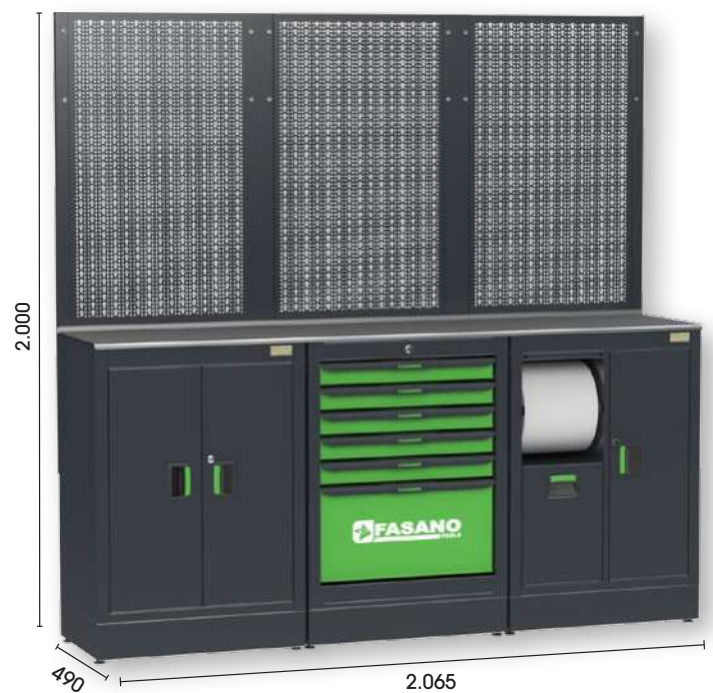

FG 116/C010V

~~3.535,00€~~ **1.879,00€**

CONFIGURAZIONE COMPOSTA DA:

- FG 116V/68A: Modulo armadietto
- FG 116/68V6: Cassettiera fissa a 6 cassetti
- FG 116V/68B: Armadietto, porta carta e porta rifiuti

CONFIGURAZIONI FG 116 DA 1.375mm



FG 116/C014V

~~2.548,00€~~ **1.299,00€**

CONFIGURAZIONE COMPOSTA DA:

- FG 116/68V6: Cassettiera fissa a 6 cassetti
- FG 116V/68B: Armadietto, porta carta e porta rifiuti

CONFIGURAZIONI FG 116 DA 1.375mm



FG 116/C015V

~~3.068,00€~~ **1.499,00€**

CONFIGURAZIONE COMPOSTA DA:

- FG 116/68V6: Cassettiera fissa a 6 cassetti
- FG 116V/68B: Armadietto, porta carta e porta rifiuti

CONFIGURAZIONI FG 116 AD ANGOLO



FG 116/C030V

~~8.078,00€~~ **3.999,00€**

CONFIGURAZIONE COMPOSTA DA:

- FG 116V/68B: Armadietto, porta carta e porta rifiuti
- FG 116V/7G: Carrello porta utensili a 7 cassetti
- FG 116V/68A: Modulo armadietto
- FG 116/68V6: Cassettiera fissa a 6 cassetti
- FG 116V/68A: Modulo armadietto

Il lavoro on the road

Arredamento furgoni!

Ai nostri clienti offriamo il massimo della qualità e dell'efficienza anche su strada. L'allestimento **Fasano Tools** per furgoni e veicoli commerciali offre la possibilità di creare l'ambiente di lavoro ideale per le proprie esigenze.

Totalmente personalizzabile e modulare, si compone di cassettiere, armadietti, mensole, scaffali e pareti provviste di griglie portautensili, porta minuterie e una vasta gamma di accessori.

Tutto il necessario per lavorare al di fuori della propria officina, seppur portandola sempre con sé.

L'arredo tecnico Fasano Tools dedicato ai veicoli attrezzati si adegua perfettamente ad ogni necessità del lavoro quotidiano. Scegli il colore e la composizione ideale!

MADE IN ITALY

Nuovi moduli in 3 varianti colore

RAL 6018

RAL 5002

RAL 3001



MODULI

ARREDAMENTO FURGONI



MANIGLIE IN ABS
CON IMPUGNATURA
ERGONOMICA



CASSETTI CON
APERTURA COMPLETA
PER MODULI
PORTA UTENSILI



VALIGIE COMPONENTI
CON SCOMPARTI
PORTA MINUTERIE



ANTE ESTRAIBILI
AD APERTURA
TOTALE



VASCHE IN PLASTICA
PORTA MINUTERIE



PIANALI
ANTISCIVOLO

LA SOLUZIONE MODULARE PER COMPORRE
L'ARREDAMENTO DEL TUO FURGONE

in 3 facili STEP



1°

STEP BASE

SELEZIONARE LA BASE:

- APERTA (SE POSIZIONATA SUL PASSARUOTA) OPPURE CHIUSA
- EVENTUALE RIALZO

2°

STEP CASSETTI

SELEZIONARE LA CASSETTIERA

(LA TIPOLOGIA ED IL NUMERO DELLE CASSETTIERE VARIANO IN FUNZIONE DELLA LARGHEZZA DELLA BASE)

3°

STEP RIPIANI

AGGIUNGERE EVENTUALI RIPIANI CON I RELATIVI MONTANTI LATERALI

(TENERE PRESENTE LA PROFONDITA' DELLA STRUTTURA E LA SAGOMA DEL FURGONE)



Progettiamo e realizziamo arredi modulari per furgoni attrezzati, in base ad esigenze specifiche e richieste del cliente.

Ogni nostro allestimento furgoni è ideato per ottimizzare gli spazi, creando un ambiente di lavoro efficiente, su misura ed altamente funzionale.

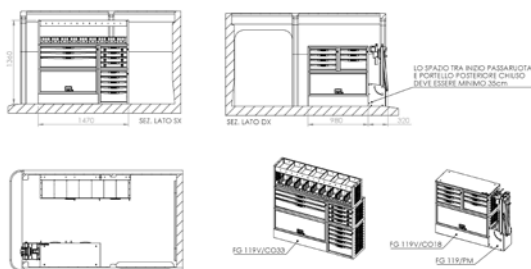



ARREDAMENTO FURGONI

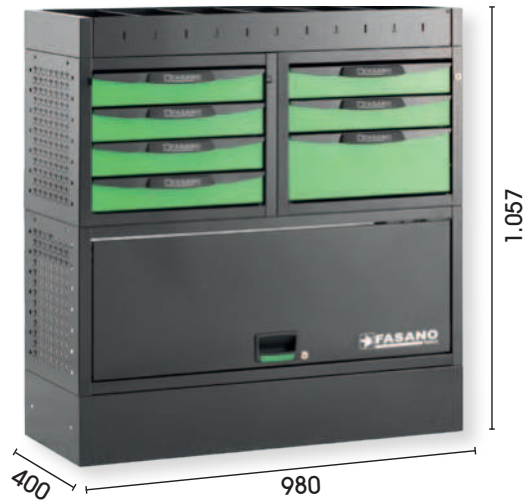

FG 119V/C016

~~2.400,00€~~ 1.199,00€

CONFIGURAZIONE ARREDAMENTO TECNICO PER FURGONI

Dimensioni: 980x400x1.057mm

Peso: 61,8 Kg



FG 119B/C016



FG 119R/C016



FG 119V/C025

~~2.930,00€~~ 1.499,00€

CONFIGURAZIONE ARREDAMENTO TECNICO PER FURGONI

Dimensioni: 1.225x400x1.057mm

Peso: 76,2 kg



FG 119B/C025



FG 119R/C025



FG 119V/C012

~~2.920,00€~~ 1.499,00€

CONFIGURAZIONE ARREDAMENTO TECNICO PER FURGONI

Dimensioni: 980x400x1.592mm

Peso: 74,9 kg



FG 119B/C012



FG 119R/C012



FG 119V/C022

~~3.478,00€~~ **1.799,00€**

**CONFIGURAZIONE ARREDAMENTO
TECNICO PER FURGONI**

Dimensioni: 1.225x400x1.592mm

Peso: 91,2 kg



FG 119B/C022



FG 119R/C022



FG 119V/C033

~~4.178,00€~~ **2.199,00€**

**CONFIGURAZIONE ARREDAMENTO
TECNICO PER FURGONI**

Dimensioni: 1.470x400x1.360mm

Peso: 114 kg



FG 119B/C033



FG 119R/C033



FG 119/BL

BANCO DA LAVORO

Dimensioni piani: 810x250mm

Peso: 22,3Kg

~~850,00€~~ **439,00€**



FG 119/PM

**BANCO DA LAVORO DOTATO
DI MORSA 125MM CON
BASE GIREVOLE**

Dimensioni piano: 560x250mm

Peso: 40,5Kg

~~1.250,00€~~ **599,00€**



AUTOMOTIVE



CHIAVE A NASTRO
REGOLABILE PER FILTRI OLIO

CODICE	Ø MM	LISTINO	€/PROMO
FG 176/RP	65-110	45,00	25,90
FG 176/RP2	110-150	48,00	27,90

FG 175/F074

CHIAVE A TAZZA PER FILTRI OLIO
FORD 1.0,2.0,2.3 ECOBOOST

~~44,00€~~ 24,90€



3/8"



FG 175/F074.5

CHIAVE A TAZZA PER FILTRI OLIO
FORD 1.5, 1.6 ECOBOOST



~~44,00€~~ 24,90€

FG 175/F014M

CHIAVE A TAZZA PER FILTRI
OLIO MOTORI MERCEDES CDI

~~34,00€~~ 19,90€



1/2"

FG 175/F014T

CHIAVE A TAZZA PER FILTRI
OLIO MOTORI TOYOTA

~~29,00€~~ 16,90€



1/2"

FG 175/OP1

CHIAVE FILTRO OLIO
OPEL/VAUXHALL

~~45,00€~~ 26,90€

NEW

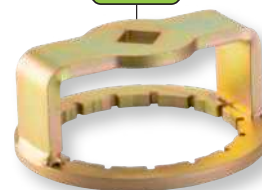

1/2"

FG 175/F084

CHIAVE A TAZZA PER FILTRI
OLIO MOTORI MERCEDES

~~55,00€~~ 32,90€



1/2"

FG 175/HI

CHIAVE A TAZZA PER FILTRI OLIO
MOTORE HYUNDAI TUCSON

~~65,00€~~ 36,90€



1/2"



FG 175/S114

**SET RIPARAZIONE
TAPPI OLIO**

- M13x1.25 - M17x1.5
- M13x1.5 - M20x1.5
- M15x1.5 - M22x1.5

~~255,00€~~ **149,00€**



FG 175/S30

**SET 28 CHIAVI A TAZZA
PER FILTRI OLIO**

~~215,00€~~ **119,00€**



FG 178/UF

**IMBUTO UNIVERSALE
PER OLIO**

~~60,00€~~ **29,90€**



FG 175/S4

**SET UTENSILI PER
SMONTAGGIO TAPPI
OLIO IN PLASTICA**

~~70,00€~~ **34,90€**

- Adatto a:
- VAG TFSI e TDI
 - FORD
 - BMW
 - CITROEN/PEUGEOT

**IMBUTI PER INSERIMENTO
LIQUIDO ADBLUE**

CODICE	CAPACITA'	LISTINO	€/PROMO
FG 491/AD1	1.1 LITRI	35,00	21,00
FG 491/AD2	1.1 LITRI	36,00	21,90



**INSERITORI AD ESPANSIONE
PER CUSCINETTI E PARA-OLI**

CODICE	Ø/MM	LISTINO	€/PROMO
FG 178/P1	9.5 - 50	85,00	45,00
FG 178/P2	18-90	110,00	59,00



FG 203/S20

KIT PER IL CONTROLLO
TENUTA DELL'IMPIANTO
DI RAFFREDDAMENTO

~~370,00€~~ **199,00€**



21Pz



FG 203/BW1

BMW



FG 203/F01

FORD Fiesta dal
2008



FG 203/F02

FORD



FG 203/OP1

OPEL



FG 203/T01

TOYOTA

TAPPI OPTIONAL

CODICE	LISTINO	€/PROMO
FG 203/BW1	35,00	21,00€
FG 203/F01	35,00	21,00€
FG 203/F02	35,00	21,00€
FG 203/OP1	35,00	21,00€
FG 203/T01	35,00	21,00€

FG 202/PV

POMPA DI PRESSIONE
E DEPRESSIONE

~~220,00€~~ **129,00€**



FG 203/S7

STRUMENTO PER IL RIEMPIMENTO A DEPRESSIONE DEI
CIRCUITI DI RAFFREDDAMENTO

- Utile per effettuare uno spurgo
perfetto grazie alla messa sotto
vuoto del circuito di raffreddamento

~~160,00€~~ **95,00€**

FG 176/S13

POMPA PER
INSERIMENTO OLIO
CAMBI E DIFFERENZIALI

Capacità 7,5 litri



~~445,00€~~ **259,00€**

- Fornito di 12 accessori per connessione diretta
- Dotato di valvola di non ritorno

FG 491/200

SIRINGA PER OLIO E FLUIDI

Fornita con 2
guarnizioni di ricambio

~~37,00€~~ **22,50€**



200CC

FG 491/1500

SIRINGA PER OLIO

Fornita con 2
guarnizioni di ricambio

~~82,00€~~ **49,50€**



1.500CC

Non adatta per
carburanti
e olii minerali



FG 191/S22

~~600,00€~~ **359,00€**

SET UNIVERSALE PER ESTRAZIONE ELETTRO-INIETTORI BOSCH, DELPHI, SIEMENS E DENSO

- completo di massa battente 4.8KG

CODICE	DESCRIZIONE	APPLICAZIONE
FG 191/ES-1	Adattatore M14X1.5	Delphi
FG 191/ES-2	Adattatore M16X1.5	Denso
FG 191/ES-3	Adattatore M25X0.5	Denso
FG 191/ES-4	Adattatore M25X0.75	Bosch
FG 191/ES-5	Adattatore M27X1.0	Denso
FG 191/ES-6	Adattatore M16X1.0	Bosch
FG 191/ES-7	Adattatore M17X1.0	Denso
FG 191/ES-8	Adattatore M20X1.0	Siemens
FG 191/ES-9	Adattatore M25X1.0	Siemens
FG 191/ES-10	Adattatore M27X1.0	Bosch
FG 191/ES-11	Estrattore a forchetta Ø 12 mm	Bosch
FG 191/ES-12	Estrattore a forchetta Ø 13.5 mm	Bosch
FG 191/ES-13	Estrattore a forchetta Ø 16 mm	
FG 191/ES-14	Estrattore a forchetta Ø 26 mm	
FG 191/ES-15	Giunto snodato	
FG 190/A25	Bussola rimozione connessione elettrica 25mm	Siemens
FG 190/A27	Bussola rimozione connessione elettrica 27mm	Siemens
FG 190/A29	Bussola rimozione connessione elettrica 29mm	Bosch
FG 190/A30	Bussola rimozione connessione elettrica 30mm	Bosch
FG 190/EL	Attrezzo rimozione elettrodo ø 7.5mm	
FG 190/EL1	Attrezzo rimozione elettrodo ø 6.9mm	

FG 190/S8

~~140,00€~~ **49,00€**

KIT ESTRAZIONE INIETTORI BMW N54/MINI N14



FG 190/AD1

ESTRATTORE A FORCHETTA PER INIETTORI PIEZO ELETTRICI

~~52,00€~~ **29,90€**

FG 190/AD2

ESTRATTORE LATERALE PER ELETTRO-INIETTORI BOSCH

~~34,00€~~ **19,90€**

Per le masse battenti da associare ai codici FG 190/AD e FG 190/AD2 consultare il Catalogo generale a pagina 175

NEW



FG 190/OP

ESTRATTORE INIETTORI OPEL MOTORI BENZINA AD INIEZIONE DIRETTA

~~45,00€~~ **26,90€**



FG 190/RE

ESTRATTORE INIETTORI DIESEL M9R - RENAULT/OPEL/NISSAN

~~235,00€~~ **139,00€**



NEW





FG 174/F2

~~70,00€~~ 42,50€

**CHIAVE REGOLABILE PER
GHIERE GALLEGGIANTI
SERBATOIO CARBURANTE
GRUPPO FCA**

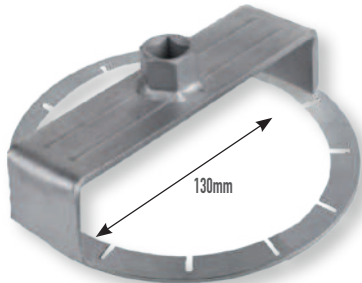

FG 175/FT1

~~65,00€~~ 39,00€

**CHIAVE PER
GHIERE GALLEGGIANTI
SERBATOIO CARBURANTE**
per ghiera in alluminio Fiat, VW,
Opel, Mercedes, BMW

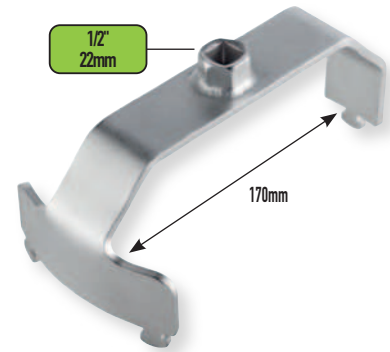

1/2"
22mm

FG 175/FT2

**CHIAVE PER
GHIERE GALLEGGIANTI
SERBATOIO CARBURANTE**
per ghiera in plastica
Citroen e Peugeot

~~80,00€~~ 49,00€

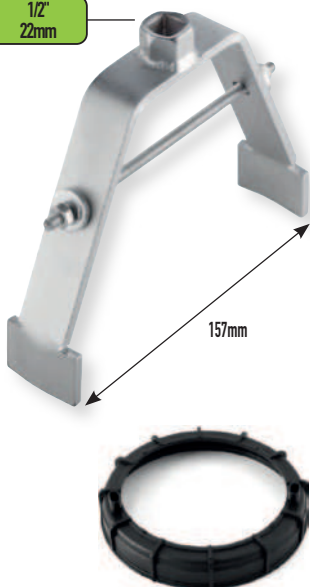

1/2"
22mm

FG 175/FT3

**CHIAVE REGOLABILE PER
GHIERE GALLEGGIANTI
SERBATOIO CARBURANTE**
per ghiera in plastica
FCA (Fiat Freemont, 500L,
500X, Jeep Renegade, ecc)

~~80,00€~~ 49,00€

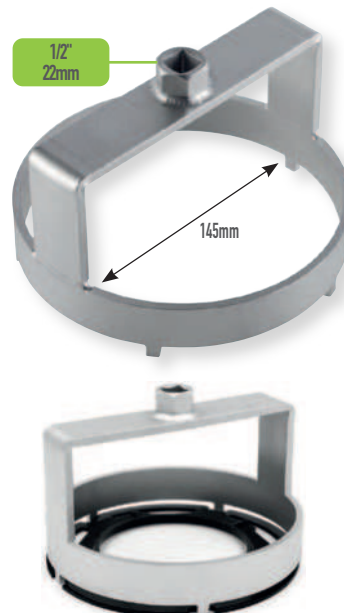

FG 175/FT4

~~70,00€~~ 42,50€

**CHIAVE PER
GHIERE GALLEGGIANTI
SERBATOIO CARBURANTE**
per ghiera in plastica gruppo VAG

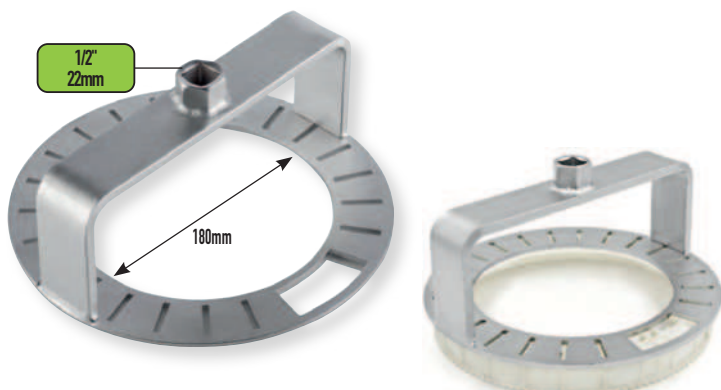

1/2"

FG 175/FT5

**CHIAVE PER
GHIERE GALLEGGIANTI
SERBATOIO CARBURANTE**
per ghiera in alluminio
gruppo OPEL

~~70,00€~~ 42,50€





FG 182/S16

**SET ESTRAZIONE
CANDELETTE SPEZZATE**
M8, M10, MULTIJET

~~500,00€~~ **299,00€**



FG 179/S16

**SET UTENSILI PER PULEGGE
LIBERE ALTERNATORI**

~~155,00€~~ **85,00€**



FG 190/S21

**ASSORTIMENTO 21 UTENSILI
E ALESATORI PER PULIZIA
SEDI INIETTORI E CANDELETTE**

~~340,00€~~ **199,00€**



FG 183/S5

**SET CHIAVI A BUSSOLA PER CANDELETTE
PRERISCALDAMENTO MOTORI DIESEL**
8, 9, 10, 12, 14mm

~~105,00€~~ **59,00€**



FG 181/S130

~~275,00€~~ **159,00€**

SET RIPRISTINA FILETTI CON ELICOIL
- M5x0.8 - M6x1.0 - M8x1.25 - M10x1.5 - M12x1.75

FG 800/9

**CHIAVE SMONTAGGIO
VALVOLE GPL GRUPPO VAG**

~~145,00€~~ **79,00€**





AUTOMOTIVE

FG 178/BF

ASPIRATORE PNEUMATICO PER LIQUIDO FRENI

- capacità: 2 Litri
- dotato di sonde e attacchi universali

~~255,00€~~ 149,00€



FG 199/SF

SIRINGA PER ESTRAZIONE OLIO CIRCUITO FRENI

- Capacità: 200CC
- Dotata di attacchi specifici per raccordi circuito freno
- Guarnizione interna in VITON

~~60,00€~~ 36,00€



FG 178/SF

~~1.760,00€~~ 899,00€

APPARECCHIO SPURGO LIQUIDO FRENI

- alimentazione 12V con cavi batteria
- dotato di vano posteriore porta oggetti e contenitore di recupero olio
- 2 tappi universali in dotazione

TAPPI IN DOTAZIONE



42mm

44,45,46mm

TAPPI SPECIFICI PER MOTORI FORD (NON IN DOTAZIONE DI BASE)



FG 178SF/AD13

Fiesta 2011-2016

~~55,00€~~ 32,90€

FG 178SF/AD14

Mondeo dal 2014
Fiesta dal 2016
Mazda CX3/CX5

~~55,00€~~ 32,90€



PRESSIONE REGOLABILE FINO A 2 BAR

CAPACITÀ SERBATOIO 5L

SCocca IN ACCIAIO INOX

DOTATO DI SENSORE FINE LIQUIDO

FG 198/S11

~~135,00€~~ 79,00€

KIT SMONTAGGIO BULLONI PINZE FRENO

BMW, Ford, VAG, Mercedes



NEW



FG 178/S6

~~330,00€~~ 169,00€

KIT TAPPI PER VEICOLI ASIATICI

- TOYOTA
- HYUNDAI
- NISSAN
- MITSUBISHI
- MAZDA
- SUBARU
- HONDA
- SUZUKI

FG 198/B7

CHIAVE A BUSSOLA PER BULLONI PINZE FRENO - 14MM

~~16,50€~~ 9,90€

FG 198/B9

CHIAVE A BUSSOLA PER BULLONI PINZE FRENO - 9MM

~~16,50€~~ 9,90€

FG 199/PF

**SET ARRETRATORE
PNEUMATICO PER
PISTONCINI FRENI
A DISCO**

Per destrorsi e sinistrorsi

~~220,00€~~ **129,00€**



FG 628/R18.5

**CHIAVE A BUSSOLA RINFORZATA PER
DADI BULLONI FORD**

Misura: 18.5x19.5mm
Attacco quadro interno: 1/2"

~~20,00€~~ **11,90€**



1/2"

FG 627/S3

**CHIAVI A BUSSOLA PER
CERCHI IN LEGA LEGGERA**

17, 19, 21mm



~~85,00€~~ **44,90€**

DOTATE DI ANELLO
MAGNETICO DI TENUTA

FG 628/S7

**CHIAVI A BUSSOLA RINFORZATE PER CERCHI IN LEGA
LEGGERA CON ADATTATORI PER BULLONI DANNEGGIATI**

17, 19, 21mm

~~115,00€~~ **69,00€**

NEW



1/2"

KIT PER RIMOZIONE DADI ANTIFURTO

FG 164/S3

**KIT RIMOZIONE DADI ANTI FURTO
CON COLLARE - BMW**

Completo di massa battente e box in ABS

~~250,00€~~ **139,00€**

FG 164/S3B

**KIT RIMOZIONE DADI ANTI FURTO
CON COLLARE - BMW**

Da usare con massa battente
FG 190MI - FG 190/MI2

~~165,00€~~ **89,00€**





AUTOMOTIVE

FG 186P/S4

SET 4 LEVE IN NYLON



~~23,00€~~ **13,90€**

FG 126/VP

LEVA PER VALVOLE PNEUMATICI

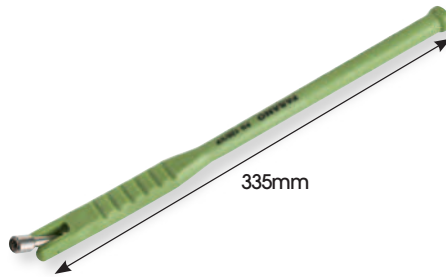

~~21,50€~~ **12,90€**

FG 198/PE

PINZA PER RIMOZIONE PESI ADESIVI EQUILIBRATURA RUOTE

NEW



~~60,00€~~ **35,90€**

FG 165/S26

~~700,00€~~ **419,00€**

SET UTENSILI SPECIALI PER SMONTAGGIO E MONTAGGIO SILENT BLOCK

- boccole per Ø 44-82mm
- 4 barre filettate M10, M12, M14, M16



FG 166/S28

KIT PER SMONTAGGIO E MONTAGGIO CUSCINETTI RUOTA

- smontaggio Ø 34-45mm
- montaggio Ø 60-84mm



~~460,00€~~ **279,00€**

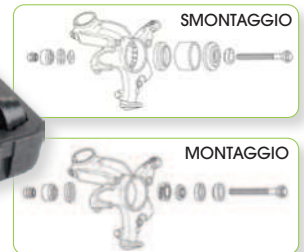

FG 165/G01

~~180,00€~~ **99,00€**

ESTRATTORE PER GIUNTI OMOCINETICI

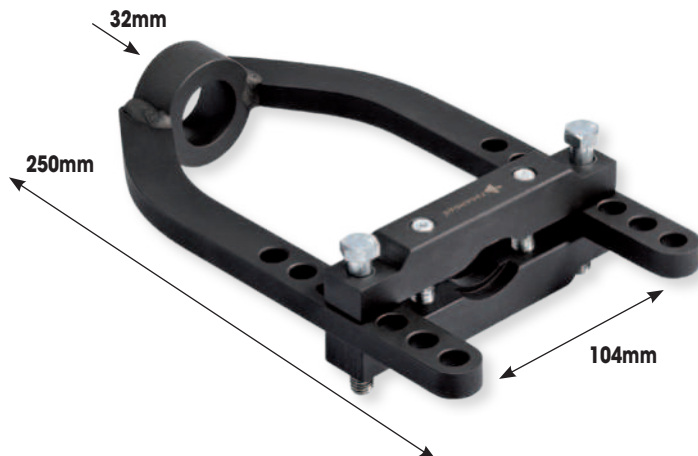

FG 165/G02

~~150,00€~~ **89,00€**

UTENSILE PER SMONTAGGIO GIUNTI OMOCINETICI

NEW





Scocca anteriore in acciaio resistente agli urti



Led di puntamento

Impugnatura Bi-material per un maggior grip

Sistema di sgancio rapido

Aggancio rinforzato

Batteria al Litio 5.0 Ampere e 18 Volt

18v - 5.0A

Coppia massima

2.900

1.000 Nm

650 Nm

BRUSHLESS MOTOR

Fornito in valigetta di ABS con 1 caricat batterie

Modalità L: -900RPM

-1.200 colpi per minuto

Modalità H: -1.900RPM

-2.400 colpi per minuto

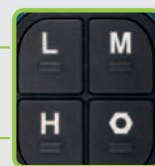

Modalità M: -1.200RPM

-1.600 colpi per minuto

Modalità svitamento soft

permette di applicare una velocità controllata finché il bullone risulta ancora bloccato



FG 166/LT2

920,00€

459,00€

AVVITATORE AD IMPULSI 18V (KIT CON 2 BATTERIE)



FG 166/LT

750,00€

399,00€

AVVITATORE AD IMPULSI 18V (KIT CON 1 BATTERIA)



AVVIATORI

CODICE	VOLT	CORRENTE DI SPUNTO	LISTINO	€/PROMO
FG 99	12	2.000A	550,00	289,00
FG 99/B	12	2.500A	670,00	355,00
FG 99/C	12 - 24	5.000A (A 12V)-2.500A (A 24V)	1.980,00	999,00



CARATTERISTICHE TECNICHE:

- Batteria ermetica al piombo (AGM)
- Alimentazione: 220V e accendisigari 12V



FG 184/S24

**KIT MONTAGGIO E
SMONTAGGIO MAGLIE
CATENE DI DISTRIBUZIONE**

~~450,00€~~ **269,00€**



FG 172/TC

**PINZA PER RIMOZIONE
PIOLI CATENE**

~~54,00€~~ **29,90€**



FG 172/FA

**PINZA PER FASCETTE
A SCATTO CLIC**

~~70,00€~~ **39,90€**



FG 172/PA

**PINZA PER SERRAGGIO E
TAGLIO FASCETTE A NASTRO
IN ACCIAIO INOX**

Ø/MM 4.7 - 9.5

INDICATA ANCHE
PER FASCETTE PANDUIT



~~65,00€~~ **39,90€**

FG 172/AS2

**PINZA PER ANELLI STRINGITUBO
CON PROLUNGA INTERCAMBIABILE**

-Apertura: 3-52mm

~~108,00€~~ **65,00€**



PROLUNGHE SINGOLE

CODICE	APERTURA	LISTINO	€/PROMO
FG 172/AS2-A	3-52MM	26,00	14,90
FG 172/AS2-B	0-75MM	50,00	29,90
FG 172/AS2-C	0-24MM	30,00	17,90
FG 172/AS2-D	PER CONNETTORI CARBURANTE	33,00	19,90



FG 184/S5

SET 5 CHIAVI PER DADI TENDICINGHIA

13, 15, 16, 17, 19mm

~~150,00€~~ **89,00€**

FG 184/S6

~~95,00€~~

39,00€

SET CHIAVE TENDICINGHIA
CON INSERTI MASCHIO

CONTENUTO:

- TX40, TX45, TX60
- H8, H10



FG 184/FT1

~~70,00€~~

39,00€

CHIAVI PER DADI TENDICINGHIA
FIAT, FORD, CITROEN, PEUGEOT



Torx



FG 184TX/S5

SET 5 CHIAVI PER DADI TENDICINGHIA

E10, E12, E14, E16, E18

~~170,00€~~ **69,00€**

NEW



FG 181/PM2

~~90,00€~~

55,00€

ESTRATTORE UNIVERSALE PER PULEGGE

FG 172/TG

PINZA RIMOZIONE TUBI
ACQUA E CARBURANTE

~~49,50€~~ **19,90€**

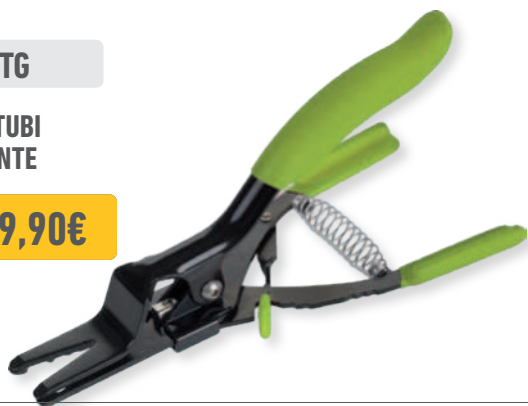

FG 172/S4

KIT UTENSILI PER SGANCIO
RACCORDI FILTRI GASOLIO

~~48,00€~~ **19,90€**



FG 171/N

PINZA PER RACCORDI
RAPIDI TUBO CARBURANTE

~~28,50€~~ **16,90€**



FG 171/FL

PINZA PER RACCORDI
RAPIDI TUBO CARBURANTE
CON TESTA FLESSIBILE

~~50,00€~~ **29,90€**



NEW



FG 215/S40

TESTER PROVA COMPRESSIONE DIGITALE, COMPLETO DI FINTI NIETTORI E FINTE CANDELETTE PER SISTEMI DIESEL

~~1.550,00€~~ 849,00€

MADE IN ITALY



ACCESSORI DI BASE IN DOTAZIONE



PROVA ALTERNATORE
PROVA TENSIONE BATTERIA



PROVA COMPRESSIONE

MADE IN ITALY



FG 219/S

~~3.200,00€~~ 1.899,00€

TESTER MULTI-FUNZIONE PER PROVA COMPRESSIONE E PROVA PRESSIONE CARBURANTI

CARATTERISTICHE TECNICHE:

- grado di precisione: 1%FS
- software in 8 lingue (IT, EN, DE, FR, ES, PT, GR, PL)
- display touch screen LCD retroilluminato a colori, 4.3"
- 2 sensori (0-80Bar e 0.2500Bar)



PROVA ALTERNATORE
PROVA TENSIONE BATTERIA



PROVA COMPRESSIONE



PROVA PRESSIONE CARBURANTE
(ALTA E BASSA)



PROVA OLIO MOTORE



NEW

CE

FG 220/BT

~~420,00€~~ **249,00€**

TESTER DIGITALE PER BATTERIE 12V E 24V

CARATTERISTICHE TECNICHE:

Dimensioni: 90X50X235 mm
Tensione di funzionamento: da 9V a 35V DC
Tempo di verifica della batteria: circa 1 minuto
Batteria interna per memoria data/ora: CR1220 (1 pezzo)



CARATTERISTICHE:	DISPLAY RETROILLUMINATO
	SOFTWARE 6 LINGUE: italiano; inglese; spagnolo; polacco; tedesco; francese
	STAMPANTE INTEGRATA CON ROTOLO DI CARTA TERMICA
	SISTEMA RILEVAZIONE FALSO CONTATTO COLLEGAMENTO PINZE
APPLICAZIONI:	TEST BATTERIE 12 E 24V
	TEST ALTERNATORE (INTELLIGENTE E NORMALE) 12-24V CARICA
	TEST SISTEMA DI AVVIAMENTO
BATTERIE SUPPORTATE:	PB, WET, GEL AGM, AGM FLAT, EFB
APPLICAZIONI:	CCA: 100-1700; IEC: 100-1000; EN: 100-1700; DIN: 100-1000; JIS
LUNGHEZZA DEI CAVI:	570 mm



FG 193DSG/S9

SET MONTAGGIO, SMONTAGGIO E REGISTRAZIONE FRIZIONI DSG 7 RAPPORTI

~~1.050,00€~~ **599,00€**



FG 193/ATJ

UTENSILE SMONTAGGIO TAPPO OLIO CAMBIO JAGUAR/LAND ROVER

~~45,00€~~ **26,90€**



FG 193DSG/S6

SET MONTAGGIO, SMONTAGGIO FRIZIONI DSG 7 RAPPORTI A SECCO

~~695,00€~~ **399,00€**



FG 193/MB

UTENSILE PER SCARICO E MISURAZIONE OLIO CAMBIO MERCEDES 9G TRONIC

~~65,00€~~ **38,90€**

Gli strumenti migliori, per veri professionisti

La gamma prodotti Fasano Tools dedicata al settore Carrozzeria comprende tutto il necessario per un lavoro altamente professionale.

Utensili performanti e caratterizzati da dettagli votati all'efficienza.

Il nostro vasto e completo assortimento di utensili per carrozzeria è dedicato a lavori di precisione e comprende kit di punzoni, set di raschietti, leve, coltelli, guidafile, impugnature, cunei, levapioli, pinze, leverini, levamolle, ventose, utensili dedicati alla rimozione di scegge ed ogni strumento essenziale per i professionisti del settore.

PRODOTTI SPECIALI

SETTORE CARROZZERIA

Scopri tutti nella sezione
AUTOMOTIVE



COLTELLO MANUALE DOTATO DI CAVO E SISTEMA FERMA CAVO



UTENSILE RIMOZIONE SCEGGE



RASCHIETTO MANUALE A LAMA DRITTA



UTENSILE RIMOZIONE GUARNIZIONI VETRI



KIT 6 VENTOSE SINGOLE



KIT 4 MINI-VENTOSE PER CRISTALLI AUTO



FG 130AL/S5

~~35,00€~~ **21,00€**

KIT PUNZONI IN PLASTICA E BULINO IN ALLUMINIO

CONTENUTO:

01 bulino in alluminio regolabile 70mm-100mm.

Filettatura M8x1.25

04 punzoni in gomma dura resistente agli urti e anti graffio



FG 186/S11

SET 11 UTENSILI IN NYLON PER CARROZZERIA

~~115,00€~~ **65,00€**



FG 184P/S3

~~25,00€~~ **14,90€**

SET 3 CUNEI IN PLASTICA

Materiale: Polipropilene ad alta resistenza



FG 184R/S3

~~45,00€~~ **26,90€**

SET 3 RASCHIETTI IN ACCIAIO CON MANICO IN ABS

Lunghezza totale: 280mm



FG 184/R1

~~20,00€~~ **11,90€**

RASCHIETTO IN ACCIAIO CON MANICO IN ABS

Lunghezza totale: 280mm



FG 184/R2

~~22,00€~~ **12,90€**

RASCHIETTO IN ACCIAIO CON PROTEZIONE IN PVC E MANICO IN ABS

Lunghezza totale: 275mm



FG 188P/S2

~~40,00€~~ **23,90€**

KIT CUNEI PER RIMOZIONE MODANATURE IN PLASTICA

Materiale: Polipropilene ad alta resistenza

1pz dotato di manico resistente alle percussioni

1pz senza manico per ideale per spazi ristretti



FG 188/P1

LEVA PER PARTI IN PLASTICA

MATERIALE: Nylon e fibra di vetro
Elevata resistenza alla torsione
Dotate di foro per appendimento

~~18,00€~~ **10,90€**



FG 185P/S4

~~25,00€~~ **14,90€**

KIT 4 LEVE PER PARTI IN PLASTICA

MATERIALE: Nylon e fibra di vetro
Elevata resistenza alla torsione
Dotate di foro per appendimento



FG 186/S3

**SET 3 LEVERINI
IN MATERIALE PLASTICO**

~~9,60€~~ **5,90€**



FG 186/S3B

**SET 3 UNCINI IN
MATERIALE PLASTICO**

~~11,20€~~ **6,80€**



FG 186P/S5

~~36,00€~~ **19,90€**

**SET 5 LEVE IN NYLON
RIMOZIONE PIOLI**



FG 185/S5

~~95,00€~~ **56,90€**

**SET 5 LEVAPIOLI
CON MANICO IN ABS**

CONTENUTO: 185/A1, FG 185/A2,
FG 185/A6, FG 185/A7, FG 185/A8



FG 185B/S2

~~40,00€~~ **23,90€**

**SET 2 LEVAPIOLI
CON MANICO IN ABS**

FG 186/S5

**SET 5 LEVE CON LAMA
IN ACCIAIO INOX**

~~95,00€~~
56,90€





FG 185/RM

**UTENSILE PER RIMOZIONE MANIGLIA
POGGIA MANO - GRUPPO VAG**

Lunghezza totale: 255mm
Impugnatura in ABS

~~30,00€~~ **17,90€**



FG 185/CR

UTENSILE LEVA MOLLE A "C"

Ideale per la rimozione delle molle a C presenti sulle manovelle alzacetro

~~10,00€~~ **5,90€**



FG 189/P01

~~20,00€~~ **11,90€**

**UTENSILE RIMOZIONE CILINDRETTO
CHIUSURA PORTIERE - GRUPPO VAG**



L/mm

UTENSILE RIMOZIONE SCHEGGE

Ideale per la pulizia del canale alzacetro
Punta sferica per evitare danneggiamenti delle guide portiera

CODICE	L/mm	LISTINO	€/PROMO
FG 182/RG10	255mm	18,00	10,90
FG 182/RG24	320mm	25,00	14,90



200

FG 183/RV1

~~20,00€~~ **11,90€**

**UTENSILE RIMOZIONE
GUARNIZIONI VETRI**

Lunghezza totale: 252mm
Impugnatura in ABS



FG 183/RA1

~~25,00€~~ **14,90€**

RASCHIETTO MANUALE A LAMA DRITTA

Fornito con una lama in dotazione
Impugnatura in ABS dotata di foro per di appendamento
Dotato di protezione lama in ABS



FG 183/CM

COLTELLO MANUALE DOTATO DI CAVO E SISTEMA FERMA CAVO

Impugnatura e cavo rivestito in PVC
Fornito con una lama da 25mm già montata

~~50,00€~~ **29,90€**



COLTELLO MANUALE DOTATO DI LAMA INTERCAMBIABILE

Fornito con una lama in dotazione
Impugnatura con rivestimento in PVC
Sistema di bloccaggio lama a vite

CODICE	L/mm	LISTINO	€/PROMO
FG 183/CK250	250mm	21,00	12,90
FG 183/CK450	450mm	32,00	18,90
FG 183/CK600	600mm	40,00	23,90



FG 187/GR

UTENSILE UNIVERSALE PER FISSAGGIO GUARNIZIONI

Dotato di 6 accessori
Sistema guida a rullo
Impugnatura in ABS

~~28,00€~~ **16,90€**

FG 187/GU

LEVA BLOCCAFILO



~~28,00€~~ **16,90€**



FG 187/IM

SET 2 IMPUGNATURE PER CAVO D'ACCIAIO

~~40,00€~~ **23,90€**

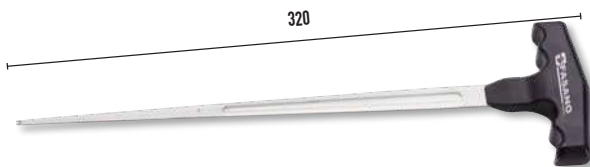

FG 187/GU2

GUIDAFILO A T CON IMPUGNATURA IN ABS

~~25,00€~~ **14,90€**

lunghezza
50 m



FG 187/W50

BOBINA DI FILO IN ACCIAIO PER TAGLIO SIGILLANTE - sezione quadrata

~~34,00€~~ **19,90€**

lunghezza
22,5 m



FG 187/WT22.5

BOBINA DI FILO IN ACCIAIO PER TAGLIO SIGILLANTE - sezione triangolare

~~25,00€~~ **14,90€**

lunghezza
50 m



FG 187/NY

BOBINA DI FILO IN NYLON IN NYLON - sezione intrecciata

~~60,00€~~ **35,90€**

lunghezza
50 m



FG 187/IW50

BOBINA DI FILO IN ACCIAIO PER TAGLIO SIGILLANTE - sezione intrecciata

~~30,00€~~ **17,90€**



FG 187/K10

KIT 4 MINI-VENTOSE PER CRISTALLI AUTO - capacità 10Kg

~~23,00€~~ **13,90€**



FG 187/S7

SET 7 UTENSILI PER CRISTALLI AUTO

~~210,00€~~ **119,00€**

FG 187/K130

VENTOSA SINGOLA MULTIFUNZIONE

- capacità: 130Kg
- diametro: 254mm
- adatta per parabrezza autobus e mezzi pesanti
- fornita in box di ABS



~~280,00€~~ **169,00€**

FG 187/K40

VENTOSA SINGOLA DOTATA DI IMPUGNATURA E SISTEMA POMPANTE

- capacità: 40 kg
- diametro: 178mm - 7"



~~190,00€~~ **109,00€**

FG 187K/S6

KIT 6 VENTOSE SINGOLE

- capacità: 10 Kg
- diametro: 78mm - 3"

~~55,00€~~ **32,90€**

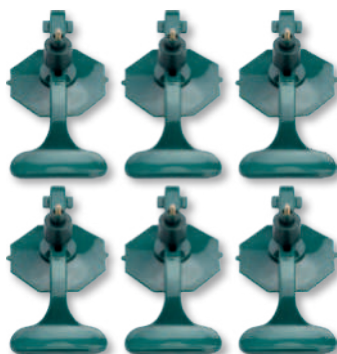

FG 187/PN

TIRABOLLI PNEUMATICO, COMPLETO DI 3 VENTOSE

~~255,00€~~ **155,00€**





PROFESSIONAL EQUIPMENT

FG 725/...T

COLONNETTE DI SOSTEGNO



CE

CODICE	CAPACITA'	H - MIN/MAX	€/PZ	€/PROMO
FG 725/3T	3 TON	285-425MM	95,00	49,00
FG 725/6T	6 TON	390-605MM	160,00	85,00
FG 725/12T	12 TON	495-720MM	280,00	149,00

FG 735/...T

SOLLEVATORI IDRAULICI A BOTTIGLIA



CE

CODICE	CAPACITA'	H - MIN/MAX	STELO	€/PZ	€/PROMO
FG 735/4T	4 TON	193-373MM	60MM	85,00	45,00
FG 735/6T	6 TON	214-416MM	70MM	98,00	49,00
FG 735/10T	10 TON	230-460MM	80MM	140,00	72,00
FG 735/16T	16 TON	230-440MM	60MM	160,00	85,00
FG 735/20T	20 TON	242-452MM	60MM	200,00	105,00

FG 750/A

CARRELLO MOVIMENTAZIONE VEICOLI
- CAPACITÀ 680KG

~~420,00€~~ **219,00€**

CE

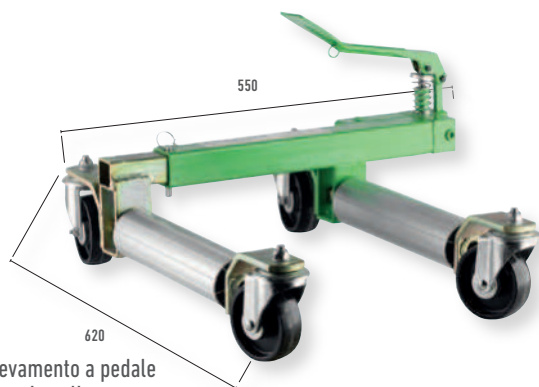

- Sistema di sollevamento a pedale
- Dotato di 4 ruote girevoli

FG 748/0.5T

SUPPORTO SOSTEGNO MOTORE
- CAPACITÀ 500KG

~~250,00€~~ **129,00€**

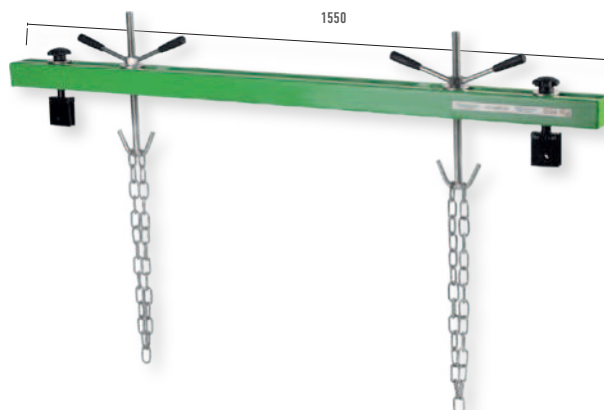

GUARDA IL VIDEO



MADE IN ITALY



SICUREZZA TOTALE

Display digitale in grado di misurare la forza di compressione applicata



AFFIDABILITA'

Le griffe sono prodotte in acciaio forgiato e sono dotate di un incavo profondo per garantire una presa totale della molla senza rischi di alcun genere per l'utilizzatore



VELOCITA' D'USO

Lo speciale sistema autocentrante permette di posizionare i bracci con una sola mano e in modo rapido

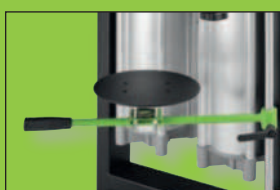

PRECISIONE

La base d'appoggio inferiore, ottenuta in materiale gommoso, è dotata di bloccaggio a volantino e permette un posizionamento preciso dell'ammortizzatore



FG 750/1P

SMONTA AMMORTIZZATORI DOTATO DI 1 PISTONE

Potenza spinta:
1.2 ton (10 bar)
- 0.9 ton (8 bar)
Corsa di compressione molla: 300mm

~~2.600,00€~~ **1.389,00€**



FG 750/2P

SMONTA AMMORTIZZATORI DOTATO DI 2 PISTONI

Potenza spinta:
2.4 ton (10 bar)
- 1.9 ton (8 bar)
Corsa di compressione molla: 300mm

~~3.300,00€~~ **1.699,00€**



FG 752/1P

SMONTA AMMORTIZZATORI DOTATO DI 1 PISTONE E DISPLAY DIGITALE

Il display digitale visualizza la pressione applicata durante la fase di utilizzo

~~3.400,00€~~ **1.699,00€**



FG 752/2P

SMONTA AMMORTIZZATORI DOTATO DI 2 PISTONI E DISPLAY DIGITALE

Il display digitale visualizza la pressione applicata durante la fase di utilizzo

~~4.100,00€~~ **1.999,00€**



PROFESSIONAL EQUIPMENT

FG 213/LT

**LEVA PER ESTRAZIONE TESTINE BRACCIO
OSCILLANTE E AMMORTIZZATORI**



~~310,00€~~

159,00€

FG 213/SM

**TRAVERSA SOSTEGNO
MOTORE INFERIORE**



~~750,00€~~

399,00€

FG 740/0.5T

~~600,00€~~

319,00€

**SOLLEVATORE IDRAULICO DA FOSSA E SOTTOPONTE
- CAPACITÀ 500KG**

- Sistema di sollevamento a pedale
- Dotato di 4 ruote girevoli

CE



FG 738/1T

~~1,100,00€~~

579,00€

**GRU IDRAULICA PIEGHEVOLE
CON POMPA A DOPPIO EFFETTO**

- Capacità: 1 Ton
- Versione richiudibile
- Dotata di pompa a doppio effetto
- Ruote in acciaio per una maggiore durata e portata

CE

Sistema di rotazione a 360° a manovella



FG 745/CMR

CAVALLETTO SOSTEGNO MOTORE RICHIUDIBILE

- Versione richiudibile
- Possibilità di rotazione a 360°
- Ruote in acciaio per una maggiore durata e portata

~~950,00€~~ **499,00€**

CE

Sistema di rotazione a 360°



FG 745/CMF

CAVALLETTO SOSTEGNO MOTORE

- Possibilità di rotazione a 360°
- Ruote in acciaio per una maggiore durata e portata

~~460,00€~~ **245,00€**

FG 722/5T

SOLLEVATORE IDRAULICO A CARRELLO 5 TON - MODELLO LUNGO PER MEZZI PESANTI

~~1,420,00€~~ **755,00€**

Sistema di sollevamento ausiliario a pedale



Ruote in acciaio montate su cuscinetti a sfera

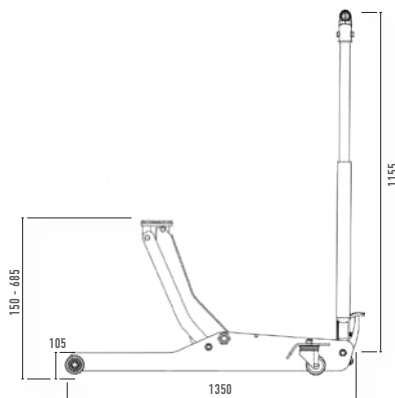



SOLLEVAMENTO TRAMITE MANICO



ROBUSTA STRUTTURA IN ACCIAIO



4 RUOTE IN NYLON



VALVOLA DI SPURGO DELL'ARIA

SOLLEVATORI IDRAULICI

3 Nuovi modelli

DIMENSIONI



FG 719/2T

SOLLEVATORE IDRAULICO 2T MODELLO LUNGO E RIBASSATO

CARATTERISTICHE TECNICHE:

- Design ribassato, ideale per lavorare anche su veicoli con bassa altezza da terra
- Versione lunga
- Robusta struttura in metallo
- Velocità di discesa controllata
- Manico con gomma antiurto
- 4 ruote in nylon
- Valvola di spurgo dell'aria
- Altezza minima 75 mm - altezza massima 610 mm
- Peso 43,5 kg

~~740,00€~~

349,00€



NEW



FG 718/2.5T

NEW

**SOLLEVATORE IDRAULICO 2.5T
MODELLO CORTO**

CARATTERISTICHE TECNICHE:

- Robusta struttura in metallo
- Velocità di discesa controllata
- Manico con gomma antiurto
- 4 ruote in nylon
- Valvola di spurgo dell'aria
- Altezza minima 75 mm - altezza massima 510 mm
- Peso 30 kg

~~470,00€~~

249,00€

CE



DIMENSIONI



FG 718/3.5T

NEW

**SOLLEVATORE IDRAULICO 3.5T
MODELLO CORTO E RIBASSATO**

CARATTERISTICHE TECNICHE:

- Design ribassato, ideale per lavorare su veicoli con bassa altezza da terra
- Portata elevata per utilizzo anche su fuoristrada e furgoni
- Robusta struttura in metallo
- Velocità di discesa controllata
- Manico con gomma antiurto
- 4 ruote in nylon
- Valvola di spurgo dell'aria
- Altezza minima 95 mm - altezza massima 540 mm
- Peso 39 kg

~~560,00€~~

295,00€

CE



DIMENSIONI





PROFESSIONAL EQUIPMENT

FG 710/A



LETTINO SOTTO MACCHINA IN PLASTICA ANTI-URTO
Dimensioni: 1.020x450x90mm

KG 136 PORTATA STATICA

~~95,00€~~ **49,00€**

FG 710/B



LETTINO SOTTO MACCHINA RICHIUDIBILE

Dimensioni da aperto: 910x415x120mm
Dimensioni da chiuso: 540x415x150mm

KG 136 PORTATA STATICA

~~120,00€~~ **64,00€**

FG 710/C

~~150,00€~~ **79,00€**

SEGGIOLINO GIREVOLE, DOTATO DI ACCESSORI



FG 710/D

~~245,00€~~ **129,00€**

SEGGIOLINO GIREVOLE, DOTATO DI ACCESSORI



FG 712/A

PORTA MINUTERIE/UTENSILI DOTATO DI RUOTE GIREVOLI

- Dotato di 2 scomparti magnetici porta minuterie
- Dotato di 2 ampi scomparti porta utensili
- Dotato di piastra centrale magnetica
- 3 ruote girevoli da 500mm
- Materiale: ABS resistente agli urti

~~50,00€~~ **19,90€**



La Rete virtuale

Comunichiamo online la nostra passione

Abitiamo la Rete del worldwide web con creatività, comunicando tutta la passione che mettiamo nel nostro lavoro, ma anche i progetti futuri, le novità e le collaborazioni.

fasanotools.com

Il nostro sito web è costantemente aggiornato ed è un importante punto di riferimento per clienti e rivenditori che, personalizzano la propria esperienza virtuale, accedendovi tramite area riservata. Il portale propone l'intero catalogo delle nostre referenze, i promozionali, i servizi nel dettaglio, i nuovi prodotti ed i contatti. Ogni utensile è corredato da informazioni precise, schede tecniche ed elenco dei relativi ricambi disponibili.

Inoltre grazie all'innovativo strumento **TOOL FINDER**, gli utenti del settore Automotive hanno la possibilità di cercare, in maniera semplice e veloce, il kit di Fasatura Motore necessario, in base al veicolo.



La nostra presenza sui **Social Media** si propone di instaurare un rapporto di fiducia con il nostro pubblico, basato sulla trasparenza e la sua stessa partecipazione alle nostre attività. In particolare, su **Facebook** coinvolgiamo i nostri utenti, clienti e appassionati di settore, con informazioni, video, immagini e contest dedicati.

Il **nostro canale Youtube** si popola di giorno in giorno con video dimostrativi, di approfondimento o relativi alle nostre partecipazioni ad eventi. Utilizziamo il nostro canale LinkedIn per comunicare contenuti specifici ad esperti e professionisti del settore. Su **Instagram**, infine, comunichiamo la nostra realtà giornalmente, mostrando i retroscena della progettazione, dei processi creativi, come i nuovi prodotti ubicati nel contesto di riferimento.

Su questo canale mondiale, l'**hashtag #fasanotools** dá voce anche ai nostri clienti e partner, mostrando tutte le sfumature di una grande realtà quale è Fasano Tools.

RIMANI AGGIORNATO

SEGUICI SUI CANALI SOCIAL



ISCRIVITI ALLA NEWSLETTER

WWW.FASANOTOOLS.COM

INDICE

CODICE	PAGINA	€/Promo
FG 22FL/S6	21	75,00
FG 22FX/S10	21	85,00
FG 22/S6	20	19,90
FG 22/S8	20	26,90
FG 22/S8B	20	29,90
FG 22/S10	20	36,90
FG 22/S12	20	52,90
FG 22TX/S6	20	37,90
FG 22E/S6	24	32,90
FG 22E/SZ6	24	32,90
FG 43/MT3	30	4,20
FG 43/MT5	30	5,50
FG 44/MT3	30	6,50
FG 44/MT5	30	10,90
FG 44/MT8	30	13,90
FG 44/MT10	30	16,90
FG 48/B	29	12,90
FG 48/K12	29	4,90
FG 48/L9	29	3,90
FG 48/KL9	29	3,50
FG 49/TC	29	23,90
FG 49/TCX	29	27,90
FG 49/L	29	9,90
FG 49/MU	29	15,90
FG 51/S4	23	55,00
FG 51/S4B	23	59,00
FG 55/S4	23	75,00
FG 55/S4B	23	79,00
FG 59IS/S3	24	59,90
FG 59PV/S3	23	39,90
FG 59XT/S3	23	49,90
FG 59XT/S3B	23	57,90
FG 68/CC	24	89,00
FG 68/TC230	24	49,00
FG 68/AT6	25	29,00
FG 68/AT16	25	29,00
FG 68/AG	25	29,00
FG 68/BNC	25	45,00
FG 68/RJ	25	39,00
FG 68U/S439	25	169,00
FG 68/SP	25	19,90
FG 68/SP2	25	8,90
FG 70/S110	28	195,00
FG 75CO/S25	28	135,00
FG 75TIN/S25	28	109,00
FG 77/PVC4	28	39,00
FG 78HSS/S12	28	129,00
FG 85/S31	22	35,00
FG 86/S30	22	49,90
FG 86/S30B	22	49,90
FG 92/GR	31	14,90
FG 93/M50	33	17,90
FG 93/M95	33	17,90
FG 92/PM	31	10,90
FG 92/PF	31	12,90
FG 92/PM4	31	12,90
FG 94/MI	65	22,90
FG 94/MS	65	16,90
FG 94/R	65	11,90
FG 94/T	65	9,90
FG 95/CA	30	28,90
FG 95/DG	30	52,50

CODICE	PAGINA	€/Promo
FG 96/DG	25	99,00
FG 96/SS30	32	28,90
FG 96/SS60	32	36,00
FG 97/T2	33	199,00
FG 98/GAS	32	72,00
FG 98/LT	32	99,00
FG 98/PC8	32	9,90
FG 98/ST8	32	9,90
FG 99	119	289,00
FG 99/B	119	355,00
FG 99/C	119	999,00
FG 100/03E	90	55,00
FG 100/03F	90	59,00
FG 100/03G	90	89,00
FG 100/03L	90	89,00
FG 100/03H	90	169,00
FG 100/07C	90	59,00
FG 100/08C	90	139,00
FG 100/10C	90	219,00
FG 100/10D	90	319,00
FG 100/17	90	79,00
FG 100/17E	90	169,00
FG 100/21B	91	139,00
FG 100/21C	91	139,00
FG 100/21D	91	95,00
FG 100/21H	91	249,00
FG 100/21M	91	95,00
FG 100/21X	91	149,00
FG 100/23C	91	129,00
FG 100/25	91	239,00
FG 100/25B	91	239,00
FG 100/39C	91	55,00
FG 100/39XT	91	62,90
FG 100/41C	91	65,00
FG 100/42C	91	68,00
FG 100/45D	92	35,00
FG 100/45E	92	45,00
FG 100/45H	92	45,00
FG 100/45I	92	45,00
FG 100/45T	92	49,00
FG 100/48G	92	79,00
FG 100/51H	92	85,00
FG 100/54	92	98,00
FG 100/56C	92	79,90
FG 100/65B	92	48,00
FG 100/65C	92	75,00
FG 100/76C	92	159,00
FG 100/81F	91	119,00
FG 100/VA1	92	13,90
FG 100B/AS56	89	1.299,00
FG 100D/AS56	89	1.299,00
FG 100R/AS56	89	1.299,00
FG 100V/AS56	89	1.299,00
FG 100W/AS56	89	1.299,00
FG 100B/AS171	86	1.149,00
FG 100D/AS171	86	1.149,00
FG 100R/AS171	86	1.149,00
FG 100V/AS171	86	1.149,00
FG 100W/AS171	86	1.149,00
FG 100B/AS177	72	1.099,00
FG 100D/AS177	72	1.099,00
FG 100R/AS177	72	1.099,00

CODICE	PAGINA	€/Promo
FG 100V/AS177	72	1.099,00
FG 100W/AS177	72	1.099,00
FG 100B/AS193	71	1.099,00
FG 100D/AS193	71	1.099,00
FG 100R/AS193	71	1.099,00
FG 100V/AS193	71	1.099,00
FG 100W/AS193	71	1.099,00
FG 100B/AS214	81	1.399,00
FG 100D/AS214	81	1.399,00
FG 100R/AS214	81	1.399,00
FG 100V/AS214	81	1.399,00
FG 100W/AS214	81	1.399,00
FG 100B/AS224	79	1.199,00
FG 100D/AS224	79	1.199,00
FG 100R/AS224	79	1.199,00
FG 100V/AS224	79	1.199,00
FG 100W/AS224	79	1.199,00
FG 100B/AS263	82	1.399,00
FG 100D/AS263	82	1.399,00
FG 100R/AS263	82	1.399,00
FG 100V/AS263	82	1.399,00
FG 100W/AS263	82	1.399,00
FG 100B/AS362	73	1.399,00
FG 100D/AS362	73	1.399,00
FG 100R/AS362	73	1.399,00
FG 100V/AS362	73	1.399,00
FG 100W/AS362	73	1.399,00
FG 100B/AS366	83	1.499,00
FG 100D/AS366	83	1.499,00
FG 100R/AS366	83	1.499,00
FG 100V/AS366	83	1.499,00
FG 100W/AS366	83	1.499,00
FG 100B/5T	62	519,00
FG 100D/5T	62	519,00
FG 100R/5T	62	519,00
FG 100V/5T	62	519,00
FG 100W/5T	62	519,00
FG 100B/6T	62	539,00
FG 100D/6T	62	539,00
FG 100R/6T	62	539,00
FG 100V/6T	62	539,00
FG 100W/6T	62	539,00
FG 100B/7T	62	559,00
FG 100D/7T	62	559,00
FG 100R/7T	62	559,00
FG 100V/7T	62	559,00
FG 100W/7T	62	559,00
FG 101V/AS106	66	499,00
FG 101V/AS123	67	599,00
FG 101V/AS136	68	699,00
FG 101V/AS182	69	799,00
FG 101V/3G	64	249,00
FG 101V/5G	61	359,00
FG 101V/6G	61	379,00
FG 101V/7G	61	399,00
FG 102B/AS155	70	999,00
FG 101D/AS155	70	999,00
FG 102R/AS155	70	999,00
FG 102V/AS155	70	999,00
FG 102B/AS195	78	999,00
FG 101D/AS195	78	999,00
FG 102R/AS195	78	999,00

CODICE	PAGINA	€/Promo
FG 102V/AS195	78	999,00
FG 102B/5G	61	469,00
FG 102D/5G	61	469,00
FG 102R/5G	61	469,00
FG 102V/5G	61	469,00
FG 102B/6G	61	499,00
FG 102D/6G	61	499,00
FG 102R/6G	61	499,00
FG 102V/6G	61	499,00
FG 102B/7G	61	529,00
FG 102D/7G	61	529,00
FG 102R/7G	61	529,00
FG 102V/7G	61	529,00
FG 102B/8G	61	559,00
FG 102D/8G	61	559,00
FG 102R/8G	61	559,00
FG 102V/8G	61	559,00
FG 102/03G	74	79,00
FG 102/03L	74	89,00
FG 102/03H	74	149,00
FG 102/03E	74	49,00
FG 102/03F	74	55,00
FG 102/07C	74	55,00
FG 102/07D	74	79,00
FG 102/08C	74	139,00
FG 102/10C	74	199,00
FG 102/13C	74	105,00
FG 102/17	74	75,00
FG 102/17E	74	159,00
FG 102/19	75	119,00
FG 102/19B	75	109,00
FG 102/21B	75	139,00
FG 102/21C	75	139,00
FG 102/21D	75	99,00
FG 102/21E	75	99,00
FG 102/21H	75	119,00
FG 102/21R	75	135,00
FG 102/21TX	75	139,00
FG 102/23C	75	79,00
FG 102/25	75	219,00
FG 102/25B	75	219,00
FG 102/39C	75	49,00
FG 102/39XT	75	58,00
FG 102/39D	75	42,00
FG 102/41C	76	55,00
FG 102/42C	76	59,90
FG 102/45D	76	26,90
FG 102/45E	76	32,90
FG 102/45F	76	29,90
FG 102/45G	76	29,90
FG 102/45U	76	55,00
FG 102/45I	76	36,90
FG 102/45L	76	39,00
FG 102/45T	76	39,00
FG 102/48D	77	49,90
FG 102/48G	77	69,90
FG 102/50F	77	45,00
FG 102/50G	77	45,00
FG 102/51H	75	79,00
FG 102/56C	77	72,90
FG 102/60C	77	26,90
FG 102/62B	77	55,00

CODICE	PAGINA	€/Promo
FG 102/65B	77	39,00
FG 102/VA1	77	8,90
FG 104B/AS242	84	1.499,00
FG 104D/AS242	84	1.499,00
FG 104R/AS242	84	1.499,00
FG 104V/AS242	84	1.499,00
FG 104B/AS284	87	1.599,00
FG 104D/AS284	87	1.599,00
FG 104R/AS284	87	1.599,00
FG 104V/AS284	87	1.599,00
FG 104B/6G	62	579,00
FG 104D/6G	62	579,00
FG 104R/6G	62	579,00
FG 104V/6G	62	579,00
FG 104B/7G	62	599,00
FG 104D/7G	62	599,00
FG 104R/7G	62	599,00
FG 104V/7G	62	599,00
FG 105B/5G	63	689,00
FG 105D/5G	63	689,00
FG 105R/5G	63	689,00
FG 105V/5G	63	689,00
FG 105B/6G	63	739,00
FG 105D/6G	63	739,00
FG 105R/6G	63	739,00
FG 105V/6G	63	739,00
FG 105B/7G	63	769,00
FG 105D/7G	63	769,00
FG 105R/7G	63	769,00
FG 105V/7G	63	769,00
FG 106/A	93	129,00
FG 106/B	93	169,00
FG 106/C	93	199,00
FG 107/A	93	89,00
FG 109D/6G	63	849,00
FG 109B/6G	63	849,00
FG 109R/6G	63	849,00
FG 109D/7G	63	879,00
FG 109B/7G	63	879,00
FG 109R/7G	63	879,00
FG 108/B	64	129,00
FG 109/L3	46	149,00
FG 111/A	47	32,90
FG 111/B	47	39,90
FG 111/C	47	49,90
FG 111/AS55	47	219,00
FG 111/AS104	47	299,00
FG 114/L2	46	33,90
FG 114/L3	46	52,50
FG 115/A	48	132,00
FG 117/A	48	219,00
FG 116/CO2V	104	2.149,00
FG 116/CO3V	104	2.599,00
FG 116/CO6V	104	2.199,00
FG 116/CO10V	104	1.879,00
FG 116/CO14V	105	1.299,00
FG 116/CO15V	105	1.499,00
FG 116/CO30V	105	3.999,00
FG 118/AS56	49	399,00
FG 118/AS75	49	329,00
FG 118/CO2V	99	2.999,00
FG 118/CO2B	99	2.999,00

CODICE	PAGINA	€/Promo
FG 118/CO2R	99	2.999,00
FG 118/CO3V	100	3.399,00
FG 118/CO3B	100	3.399,00
FG 118/CO3R	100	3.399,00
FG 118/CO8V	100	1.999,00
FG 118/CO8B	100	1.999,00
FG 118/CO8R	100	1.999,00
FG 118/CO13V	99	2.849,00
FG 118/CO13B	99	2.849,00
FG 118/CO13R	99	2.849,00
FG 118/CO20V	101	7.599,00
FG 118/CO20B	101	7.599,00
FG 118/CO20R	101	7.599,00
FG 119B/CO12	108	1.499,00
FG 119R/CO12	108	1.499,00
FG 119V/CO12	108	1.499,00
FG 119B/CO16	108	1.199,00
FG 119R/CO16	108	1.199,00
FG 119V/CO16	108	1.199,00
FG 119B/CO22	109	1.799,00
FG 119R/CO22	109	1.799,00
FG 119V/CO22	109	1.799,00
FG 119B/CO25	108	1.499,00
FG 119R/CO25	108	1.499,00
FG 119V/CO25	108	1.499,00
FG 119B/CO33	109	2.199,00
FG 119R/CO33	109	2.199,00
FG 119V/CO33	109	2.199,00
FG 119/BL	109	439,00
FG 119/PM	109	599,00
FG 125/S3	33	39,00
FG 126/VP	118	12,90
FG 127/S1	31	27,90
FG 128C/S6	31	26,90
FG 128P/S6	31	23,90
FG 128/S11	31	69,00
FG 128/2	94	349,00
FG 128/B2	94	479,00
FG 128/D2	94	479,00
FG 128/R2	94	479,00
FG 129/2	95	449,00
FG 129/B2	95	579,00
FG 129/D2	95	579,00
FG 129/R2	95	579,00
FG 130AL/S5	125	21,00
FG 131/A1	96	699,00
FG 131/B2	96	899,00
FG 131/D2	96	899,00
FG 131/R2	96	899,00
FG 132/200	30	9,90
FG 132/300	30	11,90
FG 132/500	30	12,50
FG 132/800	30	15,90
FG 132/1000	30	16,90
FG 132/B2	96	1.249,00
FG 132/D2	96	1.249,00
FG 132/R2	96	1.249,00
FG 137/B1.5	97	739,00
FG 137/D1.5	97	739,00
FG 137/R1.5	97	739,00
FG 138	22	29,90
FG 138/BP	22	33,90

CODICE	PAGINA	€/Promo
FG 138/M	22	34,90
FG 139	21	21,90
FG 139/B	21	8,90
FG 139/C	21	12,90
FG 139/D	21	11,90
FG 139/E	21	18,90
FG 139/LM	21	29,90
FG 139/L	21	22,90
FG 139/S9	21	19,90
FG 150H/S30	18	119,00
FG 150M/S26	18	109,00
FG 150TX/S32	18	115,00
FG 150D/AS167	80	1.299,00
FG 150R/AS167	80	1.299,00
FG 150D/5G	64	529,00
FG 150R/5G	64	529,00
FG 150D/6G	64	549,00
FG 150R/6G	64	549,00
FG 150D/7G	64	579,00
FG 150R/7G	64	579,00
FG 152RH/S9	19	69,00
FG 152RM/S9	19	69,00
FG 152/RTXS10	19	99,00
FG 160B/AS290	85	2.999,00
FG 160D/AS290	85	2.999,00
FG 160R/AS290	85	2.999,00
FG 160V/AS290	85	2.999,00
FG 160B/14L	65	1.889,00
FG 160D/14L	65	1.889,00
FG 160R/14L	65	1.889,00
FG 160V/14L	65	1.889,00
FG 162/S3	50	215,00
FG 162/ME	51	18,90
FG 163/S2B	50	149,00
FG 164/S3	117	139,00
FG 164/S3B	117	89,00
FG 165/1	51	169,00
FG 165/2	51	209,00
FG 165/3	51	309,00
FG 165/IE1	50	179,00
FG 165/IE2	50	439,00
FG 165/MB1	50	99,00
FG 165/MB2	50	189,00
FG 165/GO1	118	99,00
FG 165/GO2	118	89,00
FG 166/LT	119	399,00
FG 166/LT2	119	459,00
FG 165/S26	118	419,00
FG 166/S28	118	279,00
FG 168EP/S5	51	18,90
FG 168/S25	51	79,00
FG 171/FL	121	29,90
FG 171/N	121	16,90
FG 172/AS2	120	65,00
FG 172/AS2-A	120	14,90
FG 172/AS2-B	120	29,90
FG 172/AS2-C	120	17,90
FG 172/AS2-D	120	19,90
FG 172/FA	120	39,90
FG 172/TC	120	29,90
FG 172/TG	121	19,90
FG 172/S4	121	19,90

CODICE	PAGINA	€/Promo
FG 172/PA	120	39,90
FG 174/F2	114	42,50
FG 175/FO14M	110	19,90
FG 175/FO14T	110	16,90
FG 175/FO74	110	24,90
FG 175/FO74.5	110	24,90
FG 175/FO84	110	32,90
FG 175/FT1	114	39,00
FG 175/FT2	114	49,00
FG 175/FT3	114	49,00
FG 175/FT4	114	42,50
FG 175/FT5	114	42,50
FG 175/Hi	110	36,90
FG 175/S30	111	119,00
FG 175/S4	111	34,90
FG 175/S114	111	149,00
FG 175/OP1	110	26,90
FG 176/RP	110	25,90
FG 176/RP2	110	27,90
FG 176/S13	112	259,00
FG 178/UF	111	29,90
FG 178/BF	116	149,00
FG 178/SF	116	899,00
FG 178SF/AD13	116	32,90
FG 178SF/AD14	116	32,90
FG 178/S6	116	169,00
FG 179/S16	115	85,00
FG 178/P1	111	45,00
FG 178/P2	111	59,00
FG 180/SP6	9	69,00
FG 180/SP9	9	119,00
FG 181/PM2	121	55,00
FG 181/S130	115	159,00
FG 182/S5B	51	279,00
FG 182/S14	51	139,00
FG 182/S16	115	299,00
FG 182/RG10	127	10,90
FG 182/RG24	127	14,90
FG 183/S5	115	59,00
FG 183/CM	128	29,90
FG 183/CK250	128	12,90
FG 183/CK450	128	18,90
FG 183/CK600	128	23,90
FG 183/RA1	127	14,90
FG 183/RV1	127	11,90
FG 184P/S3	125	14,90
FG 184/R1	125	11,90
FG 184/R2	125	12,90
FG 184R/S3	125	26,90
FG 184/S24	120	269,00
FG 184/FT1	121	39,00
FG 184/S5	121	89,00
FG 184/S6	121	39,00
FG 184TX/S5	121	69,00
FG 185/S5	126	56,90
FG 185B/S2	126	23,90
FG 185/RM	127	17,90
FG 185/CR	127	5,90
FG 185P/S4	126	14,90
FG 186/S5	126	56,90
FG 186P/S4	118	13,90
FG 186P/S5	126	19,90

INDICE

CODICE	PAGINA	€/Promo
FG 186/S3	126	5,90
FG 186/S3B	126	6,80
FG 186/S11	125	65,00
FG 187/GU	128	16,90
FG 187/GU2	128	14,90
FG 187/IM	128	23,90
FG 187/IW50	128	17,90
FG 187/NY	128	35,90
FG 187/S7	129	119,00
FG 187/PN	129	155,00
FG 187/W50	128	19,90
FG 187/WT22.5	128	14,90
FG 187/K10	129	13,90
FG 187/K40	129	109,00
FG 187K/S6	129	32,90
FG 187/K130	129	169,00
FG 187/GR	128	16,90
FG 188/P1	126	10,90
FG 188P/S2	125	23,90
FG 189/PO1	127	11,90
FG 190/AD1	113	29,90
FG 190/AD2	113	19,90
FG 190/OP	113	26,90
FG 190/RE	113	139,00
FG 190/S8	113	49,00
FG 190/S21	115	199,00
FG 191/S22	113	359,00
FG 193/ATJ	123	26,90
FG 193/MB	123	38,90
FG 193DSG/S6	123	399,00
FG 193DSG/S9	123	599,00
FG 198/PE	118	35,90
FG 198/S11	116	79,00
FG 198/B7	116	9,90
FG 198/B9	116	9,90
FG 199/PF	117	129,00
FG 199/SF	116	36,00
FG 202/PV	112	129,00
FG 203/BW1	112	21,00
FG 203/FO1	112	21,00
FG 203/FO2	112	21,00
FG 203/OP1	112	21,00
FG 203/TO1	112	21,00
FG 203/S7	112	95,00
FG 203/S20	112	199,00
FG 203	35	12,90
FG 204	34	17,90
FG 205	39	49,00
FG 213/L480	37	39,00
FG 214/L600	37	39,00
FG 206	34	29,90
FG 207	35	33,90
FG 208	38	119,00
FG 209	38	149,00
FG 210/A	35	49,90
FG 210/B	39	49,00
FG 211	36	59,00
FG 217	40	149,00
FG 212	36	39,00
FG 213/LT	132	159,00
FG 213/SM	132	399,00
FG 215/S40	122	849,00

CODICE	PAGINA	€/Promo
FG 219/S	122	1.899,00
FG 220/BT	123	249,00
FG 225/SK1.5	41	149,00
FG 225/SK2.5	41	169,00
FG 234	42	59,00
FG 235	42	79,00
FG 236	43	199,00
FG 236/SU	43	59,00
FG 491/200	112	22,50
FG 491/1500	112	49,50
FG 491/AD1	111	21,00
FG 491/AD2	111	21,90
FG 493/AL2	33	26,90
FG 493/AL3	33	32,90
FG 493/N	33	23,50
FG 494/A180	33	99,00
FG 494/S12	33	32,90
FG 531	26	119,00
FG 533/2	26	135,00
FG 536/1	26	135,00
FG 536/2	26	139,00
FG 536/3	26	156,00
FG 538/1	26	459,00
FG 538/2	26	519,00
FG 539/1	26	659,00
FG 543/DG1	27	379,00
FG 543/DG2	27	449,00
FG 546/DG	27	189,00
FG 547/DG	27	119,00
FG 559/1	27	119,00
FG 559/2	27	129,00
FG 559/3	27	135,00
FG 581/A	27	489,00
FG 581/B	27	809,00
FG 600/SC17	8	99,00
FG 600/SC16	8	129,00
FG 600/SC25	8	199,00
FG 600/ST9	8	55,00
FG 600E/S4	10	29,90
FG 602/SC13	8	85,00
FG 602C/SP9	8	54,00
FG 603/TA1	88	139,00
FG 605/ST9-B	11	105,00
FG 605/ST11-B	11	129,00
FG 605/SC15	11	145,00
FG 605/SP6	11	63,00
FG 606/SP9	11	78,00
FG 609A/S5	10	55,00
FG 610FL/SP9	11	129,00
FG 613/S9	9	105,00
FG 615A/S6	10	75,00
FG 618/S7B	9	149,00
FG 618/S7	9	159,00
FG 618/S10	9	235,00
FG 618E/S9	9	249,00
FG 619H/S6	9	135,00
FG 619TX/S8	9	199,00
FG 621H/S8C	10	89,00
FG 621TX/S13	10	129,00
FG 622A/S2	10	49,00
FG 622A/S6	10	79,00
FG 624B/S16	13	89,00

CODICE	PAGINA	€/Promo
FG 624B/TXS10	13	49,00
FG 624/CR14	12	22,90
FG 624/FR14	12	23,90
FG 624/RT14	12	38,50
FG 624/S12	14	49,00
FG 624/S25	13	49,00
FG 624/S25A	13	49,00
FG 624/S29	13	129,00
FG 625AM/S3	19	28,90
FG 625A/S12	14	79,00
FG 625/S12	14	72,00
FG 625/S27	14	99,00
FG 625/S74	16	129,00
FG 625/S94	16	149,00
FG 625/S110	17	239,00
FG 625/CR12	12	29,90
FG 625/FR12	12	32,90
FG 625/RT12	12	48,90
FG 625TX/S13	14	69,00
FG 628/R18.5	117	11,90
FG 628/S12	19	79,00
FG 628/S6	19	55,00
FG 627/S3	117	44,90
FG 628/S7	117	69,00
FG 629A/S15	18	329,00
FG 629B/S15	18	329,00
FG 629C/S10	19	149,00
FG 710/A	136	49,00
FG 710/B	136	64,00
FG 710/C	136	79,00
FG 710/D	136	129,00
FG 712/A	136	19,90
FG 712/L4	31	49,00
FG 718/2.5T	135	249,00
FG 718/3.5T	135	295,00
FG 719/2T	134	349,00
FG 722/5T	133	755,00
FG 725/3T	130	49,00
FG 725/6T	130	85,00
FG 725/12T	130	149,00
FG 735/4T	130	45,00
FG 735/6T	130	49,00
FG 735/10T	130	72,00
FG 735/16T	130	85,00
FG 735/20T	130	105,00
FG 738/1T	132	579,00
FG 740/0.5T	132	319,00
FG 745/CMF	133	245,00
FG 745/CMR	133	499,00
FG 748/0.5T	130	129,00
FG 750/A	130	219,00
FG 750/1P	131	1.389,00
FG 750/2P	131	1.699,00
FG 752/1P	131	1.699,00
FG 752/2P	131	1.999,00
FG 800/9	115	79,00
FG 1425	45	54,00
FG 1426	45	64,00
FG 1427	45	90,00
FG 1433	45	105,00
FG 1434	45	76,50
FG 1438/S4B	45	359,00

CODICE	PAGINA	€/Promo
FG 1438/S4C	45	379,00
FG 1440	46	29,90
FG 1445	46	23,90
FGA 291/B	55	75,00
FGA 291/C	55	79,00
FGA 292/B	53	129,00
FGA 302	53	125,00
FGA 307	52	149,00
FGA 307/AN	53	179,00
FGA 309	52	179,00
FGA 312	53	199,00
FGA 316	54	429,00
FGA 316/L	54	479,00
FGA 319	54	599,00
FGA 319/L	54	649,00
FGA 321	54	559,00
FGA 321/B	54	579,00
FGA 321/C	55	599,00
FGA 322	55	85,00
FGA 330	57	159,00
FGA 332	56	89,00
FGA 332/AN	56	109,00
FGA 333	56	109,00
FGA 333/AC	56	125,00
FGA 334	58	85,00
FGA 334/AN	58	109,00
FGA 334/AN115	58	109,00
FGA 334/L	58	109,00
FGA 335	57	109,00
FGA 336	57	359,00
FGA 337	57	75,00
FGA 338	58	75,00
FGA 338/B	58	95,00
FGA 338/AN	58	99,00
FGA 338/L	58	99,00
FGA 339/B	57	99,00
FGA 339/B-G60	57	5,40
FGA 339/B-G80	57	6,00
FGA 339/B-G120	57	7,20
FGA 340	56	169,00
FGA 340/B	56	169,00
FGA 342	59	125,00
FGA 342/B	56	169,00
FGA 343/N10	59	129,00
FGA 343/N20	59	165,00
FGA 346/B	57	129,00
FGA 383/AR15	59	139,00
FGA 385/AR15	59	169,00
FGA 385	59	79,00
FGA 386	59	79,00
FGA 387	59	79,00
FGA 390	55	85,00
FG 603/S28A	88	499,00
FG 603/S28B	88	499,00
FG BEST 108	15	139,00
FG BEST 171	15	179,00

DISTRIBUTORE UFFICIALE



FASANGAS S.r.l.

Viale Grecia 3, lotto 18
73100 Zona Industriale LECCE (LE) ITALY
(+39) 0832.362097/364265
info@fasanotools.com

VALIDITA' 1-02-2023/14-01-2024

FASANOTOOLS.COM

