



FASANO

TOOLS

PROMODAY

2024

ITALIA € IVA ESCLUSA



	CHIAVI DI MANOVRA	8
	CHIAVI A BUSSOLA	12
	GIRAVITI E PINZE	20
	ELETTRONICA E ELETTROTECNICA	24
	UTENSILI DINAMOMETRICI	26
	UTENSILI DA TAGLIO	28
	MANUTENZIONE GENERALE	30
	LAMPADE	34
	BORSE DA LAVORO	42
	ESTRATTORI	48
	UTENSILI PNEUMATICI	50
	CARRELLI E BANCHI DA LAVORO	58
	ARREDAMENTO TECNICO	98
	ARREDAMENTO FURGONI	106
	AUTOMOTIVE	110
	PROFESSIONAL EQUIPMENT	130

L'azienda

Realizziamo strumenti professionali dal 1976

Nata nel 1976, l'azienda lancia nel 2002 il marchio **FASANO TOOLS** che, sin da subito, si pone sul mercato come un brand innovativo ed alternativo nel mondo dell'utensileria professionale. **Oltre 40 anni** di esperienza e l'ascolto continuo di fruitori e partner commerciali, hanno consentito all'impresa di crescere e diventare una realtà di riferimento nel settore, consolidare la sua presenza a livello Nazionale e rafforzare quella a livello Internazionale.

NUOVA

SEDE PRODUTTIVA

L'ampliamento della gamma di prodotti degli ultimi anni, corrisponde ad un ampliamento strutturale della sede operativa Fasano Tools.

PIÙ SPAZIO PER NUOVI PROGETTI

Con una superficie di oltre 1000 mq, il nuovo stabilimento Fasano Tools, realizzato nel 2023, oggi ospita diverse attività a pieno regime quali il taglio e la punzonatura, la piegatura automatica, la saldatura e l'assemblaggio di tutti i prodotti lamierati presenti a catalogo.



I nostri tecnici specializzati, al suo interno, lavorano, grazie all'ausilio di macchinari innovativi ad alta vocazione tecnologica, alla produzione di lamierati per la messa in opera di carrelli porta utensili, armadi, cassettiere ed ogni altro modulo e struttura di arredo tecnico industriale.

Il nuovo stabilimento, per ora a pieno regime su queste attività specifiche, nel corso del 2024 sarà destinato anche allo studio ed alla realizzazione di nuovi progetti, già in cantiere.





Fasano Tools si differenzia sul mercato per l'**ampia gamma di attrezzi** da lavoro che copre tutti i settori di riferimento e per la vasta e costante disponibilità dei ricambi. Punti di forza della nostra realtà sono, infatti, l'assistenza e l'attenzione alle certificazioni, volontarie e obbligatorie, alle quali sono sottoposti puntualmente i prodotti, per rispettare, come da norme vigenti, gli standard internazionali.

Supporto fondamentale per l'attività di **Fasano Tools è il sito web**, straordinariamente ricco di informazioni sui prodotti, schede tecniche dettagliate, manuali, elenco ricambi e strumenti innovativi per trovare l'attrezzo o il kit necessario al proprio lavoro. Come il Tool Finder, rivoluzionario motore di ricerca interno, dedicato alla gamma dei prodotti per fasatura motore.

La comunicazione di Fasano Tools si estende, inoltre, dal web al mondo dei Social media, dove si caratterizza per un'attività mirata e differente per ogni Canale.

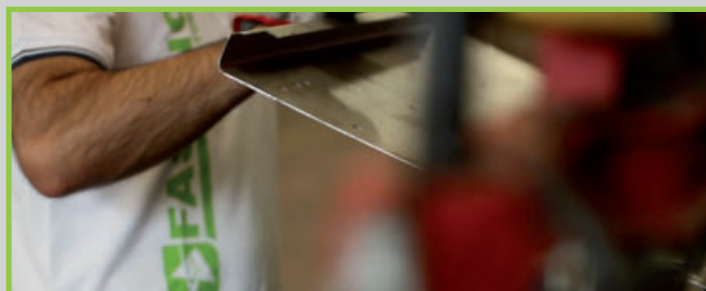

Con oltre 40 anni di esperienza, l'azienda ha una **VISION** ben chiara.

Si propone di non perdere mai quello spirito critico verso il mondo e il mercato e, attraverso l'impegno costante e la ricerca di innovazioni a supporto del lavoro, di affrontare con flessibilità le sfide del settore e di anticiparne le evoluzioni. **Oggi come ieri.**

NUOVE BORSE PORTA UTENSILI

CAPIENTI, COMODE E SUPER FUNZIONALI. CON LE NUOVE BORSE PORTA UTENSILI FASANO TOOLS PORTI IL TUO LAVORO OVUNQUE E TUTTO QUELLO CHE TI SERVE È SEMPRE CON TE!

6 NUOVI MODELLI per ogni esigenza lavorativa. **Ampi scomparti separati e tasche multiple, laterali e frontali**, per riporre i tuoi utensili, differenziandone l'utilizzo e riprendere poi ciò che ti serve, senza perdere tempo. Non solo attrezzi! I nostri modelli di borse porta utensili sono ideati per trasportare anche oggetti di uso quotidiano come pc, chiavi, smartphone e tutto il necessario per lavorare fuori dagli ambienti di lavoro.



NEW



TROLLEY, TRACOLLE, CESTELLI, BORSONI E ZAINI

Scegli lo **zaino** con gli **spallacci** imbottiti per avere le mani libere e conservare documenti e pc portatile. Con lo **zaino** **provvisto di manico telescopico** e ruote invece, puoi viaggiare anche in aereo e fare lunghi tragitti a piedi, senza fatica.

Prediligi un **cestello con copertura**, se preferisci il connubio tra la classica cassetta porta attrezzi ed un borsoni provvisto di tracolla.

Due **borsoni** con ampi scomparti interni e tasche esterne, ti permettono di separare gli oggetti di uso quotidiano dagli utensili da lavoro.

Puoi scegliere tra una struttura completamente rigida o una semi rigida.

Infine, con il **trolley**, trasporti con facilità utensili elettrici o manuali di peso maggiore, dove vuoi, senza sforzi.

Tutte realizzate in tessuto tecnico, le Borse Porta Utensili Fasano Tools sono la tua soluzione versatile ad ogni esigenza giornaliera. E che stile!





TSC
SYSTEM

TECNOLOGIA DI
SPEGNIMENTO
PER CONTATTO



AMPIA GAMMA DI LAMPADE A LED



FUNZIONI INNOVATIVE
CHE RENDONO SEMPLICI
LE OPERAZIONI PIÙ COMPLICATE.



RISPARMIO
ENERGETICO



MASSIMA
AUTONOMIA



FUNZIONE
POWER BANK



TSC
SYSTEM



CASSE
WIRELESS



GRADO
DI PROTEZIONE
IP65



CASSE WIRELESS



GRADO
DI RESISTENZA
AGLI URTI IK 07



CARICABATTERIE



TROVA LA GIUSTA CARICA PER IL TUO LAVORO!

NEW

Con i nuovi **CARICABATTERIE FASANO TOOLS**, l'energia a disposizione non finisce mai.

**IDEALI PER MOTO,
AUTO, MA ANCHE
FURGONI,
IMBARCAZIONI
E MEZZI PESANTI.**



I nostri **CARICABATTERIE** presentano alcune funzioni davvero eccezionali che assicurano **UN ALTO GRADO DI EFFICIENZA ENERGETICA.**

**JUMP
MODE**

**WINTER
MODE**





BE STRONG.
BE POWERFUL.
BE BRAVE.
BI COLOR

L'ICONICO CARRELLO
FG 100 FASANO TOOLS
DIVENTA ANCHE
BI COLOR!

4 RUOTE IN GOMMA VULCANIZZATA
CON DIAMETRO 125 MM
(2 FISSE, 2 GIREVOLI)
VERSATILITA'

7 CASSETTI CAPIENTI,
TOTALMENTE APRIBILI E CORREDATI
DI TAPPETINO INTERNO ANTIGRAFFIO
CAPIENZA

Scegli tra le
14 VARIANTI
disponibili,
il match che
ti rappresenta
di più!

CHIUSURA LATERALE
CENTRALIZZATA
SICUREZZA

PANNELLI LATERALI
CON FORI PER GANCI PORTA UTENSILI
E PORTA FLACONI DI SERIE
COMODITA'

TOP IN ABS
CON MANIGLIONE INTEGRATO
PRATICITA'

L'ENERGIA
DEI NOSTRI
NUOVI
FG 100
BI COLOR



IL MEGLIO DEL
MADE IN ITALY

I nostri carrelli sono frutto di un intenso lavoro di ricerca, sviluppo, progettazione e produzione interna.



FG 600L/SC10

**SET CHIAVI COMBinate
POLIGONALI EXTRA LUNGHE**

CONTENUTO:
10, 11, 12, 13, 14, 15, 16, 17, 18, 19mm

~~155,80€~~ **89,00€**



FG 600/SC16

**SET 16 CHIAVI
COMBinate POLIGONALI**

CONTENUTO:
6,7,8,10,12,13,14,16,
17,19,21,22,24,27,30,32 mm

~~232,00€~~ **139,00€**



FG 615/SC8

**SET CHIAVI POLIGONALI
DOPPIE CURVE**

CONTENUTO:
6x7, 8x9, 10x11, 12x13, 14x15, 16x17,
18x19, 20x22mm

~~113,80€~~ **69,00€**



FG 600/SC17

**SET 17 CHIAVI COMBinate
POLIGONALI IN BOX DI CARTONE**

CONTENUTO:
6, 7, 8, 9, 10, 11, 12, 13, 14,
15, 16, 17, 18, 19, 20, 21, 22 mm

~~182,00€~~ **99,00€**



FG 600/SC25

**SET 25 CHIAVI COMBinate
POLIGONALI IN BOX DI CARTONE**

CONTENUTO:
6, 7, 8, 9, 10, 11, 12, 13, 14, 15, 16,
17,18, 19, 20, 21, 22, 23, 24, 25, 26, 27,
28, 30,32 mm

~~390,00€~~ **209,00€**



FG 602/SC13

**SET 13 CHIAVI A DOPPIA
FORCHETTA IN BOX DI CARTONE**

CONTENUTO:
6x7, 8x9, 10x11, 12x13, 14x15, 16x17,
18x19, 20x22, 21x23,
24x26, 25x28, 27x29, 30x32 mm

~~145,00€~~ **89,00€**



FG 614B/S13

~~185,00€~~ **99,00€**

SET CHIAVI A TUBO MOD. LEGGERO

CONTENUTO:

6x7, 8x9, 10x11, 12x13, 14x15, 16x17, 18x19, 20x22,
21x23, 24x26, 25x28, 27x29, 30x32mm



FG 180/SP6

~~125,00€~~ **72,50€**

SET 6 CHIAVI PER RACCORDI TUBO IN ROTOLO DI NYLON
CONTENUTO: 8x10, 10x11, 11x13, 12x14, 17x19, 19x22mm

FG 180/SP9

~~216,00€~~ **125,00€**

SET 9 CHIAVI PER RACCORDI TUBO IN ROTOLO DI NYLON
CONTENUTO: 8x10, 9x11, 10x11, 11x13, 12x14, 17x19, 19x22, 24x27, 30x32mm



FG 616A/S6

SET 6 CHIAVI A T ESAGONALI SEMPLICI

CONTENUTO: 8, 10, 12, 13, 14, 17mm

~~135,00€~~ **79,00€**



FG 618E/S9

SET 9 CHIAVI A T SNODATE TORX IN BOX DI CARTONE

CONTENUTO: E6, E7, E8, E10, E12, E14, E16, E18, E20

~~439,00€~~ **249,00€**



FG 618/S7B

SET 7 CHIAVI A T SNODATE ESAGONALI

CONTENUTO:
7, 8, 10, 12, 13, 14, 17mm

~~257,50€~~ **155,00€**



FG 618/S7

SET 7 CHIAVI A T SNODATE ESAGONALI

CONTENUTO:
8, 10, 11, 13, 14, 17, 19 mm

~~278,50€~~ **169,00€**



FG 618/S10

SET 10 CHIAVI A T SNODATE ESAGONALI

CONTENUTO:
8, 10, 11, 12, 13, 14,
15, 16, 17, 19 mm

~~404,50€~~ **239,00€**



CHIAVI DI MANOVRA

ASTA SCORREVOLE



FG 621H/S8C

SET 8 CHIAVI A T MASCHIO ESAGONALI CON ASTA SCORREVOLE

~~152,00€~~ **89,00€**

CONTENUTO: 2,2.5,3,4,5,6,8,10mm

ASTA SCORREVOLE



FG 621TX/S13

SET 13 CHIAVI A T MASCHIO TORX CON ASTA SCORREVOLE

~~235,00€~~ **129,00€**

CONTENUTO: 6,7,8,9,10,15, 20,25,27,30,40, 45,50 TX

CHIAVE POLIGONALE DOPPIA



FG 609A/S5

~~102,00€~~ **59,00€**

SET 5 CHIAVI DOPPIE POLIGONALI

CONTENUTO: 10x12, 11x13, 14x17, 16x18, 19x22 mm

CHIAVE DOPPIA DIRITTA TORX



FG 600E/S4

~~53,56€~~ **32,00€**

SET 4 CHIAVI DOPPIE DIRITTE TORX

CONTENUTO: E6xE8, E10xE12, E14xE18, E20xE24

FG 617A/S7

SET 7 CHIAVI A TESTA FLESSIBILE CON CRICCO UNIVERSALE

CONTENUTO: 8, 10, 12, 13, 14, 15, 17mm

~~165,00€~~ **75,00€**



FG 615A/S6

SET 6 CHIAVI DOPPIE CON CRICCO REVERSIBILE UNIVERSALE A 90 DENTI

CONTENUTO: 8x9, 10x11, 12x13, 14x15, 16x18, 17x19mm

~~130,00€~~ **75,00€**

FG 622A/S2

SET 2 CHIAVI A CRICCO UNIVERSALE SERIE EXTRA-LUNGA

CONTENUTO: 21x22, 24x27 mm

~~80,00€~~ **49,00€**





FG 606/SP9

~~132,00€~~ **79,00€**

SET 9 CHIAVI COMBinate NON REVERSIBILI IN ROTOLO DI NYLON

CONTENUTO: 8,10,11,12,13,14,15,17,19 mm



FG 610FL/SP9

~~236,00€~~ **135,00€**

SET 9 CHIAVI COMBinate A CRICCO FLESSIBILI IN ROTOLO DI NYLON

CONTENUTO: 8, 10, 12, 13, 15, 16, 17, 18, 19 mm



FG 605/SP6

~~110,00€~~ **65,00€**

SET 6 CHIAVI COMBinate REVERSIBILI IN ROTOLO DI NYLON

CONTENUTO:
8,10,13,14,17,19 mm



FG 605/SC15

~~258,00€~~ **149,00€**

SET 15 CHIAVI COMBinate A CRICCO REVERSIBILI IN BOX DI CARTONE

CONTENUTO:
6,7,8,9,10,11,12,13,14,15,16,17,18,19,22 mm

CHIAVE COMBINATA A CRICCO REVERSIBILE CON ANELLO DI TENUTA

ANELLO IN ACCIAIO INTEGRATO CHE CONSENTE LA TENUTA DEL BULLONE



LEVA DI INVERSIONE A FILO TESTA E CON LINGUETTA INCLINATA VERSO IL BASSO PER UN MAGGIORE SPAZIO DI MANOVRA

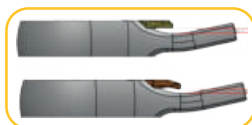

FG 605/ST9-B

SET 9 CHIAVI A CRICCO REVERSIBILI CON SUPPORTO IN ABS

CONTENUTO: 8,10,11,12,13,14,15,17,19mm

~~190,00€~~ **109,00€**

FG 605/ST11-B

SET 11 CHIAVI A CRICCO REVERSIBILI CON SUPPORTO IN ABS

CONTENUTO: 8,9,10,11,12,13,14,15,16,17,19mm

~~232,00€~~ **129,00€**



1/4"

FG 624/MCR

~~36,80€~~

21,90€

**MINI CRICCHETTO CON ATTACCO
QUADRO MASCHIO 1/4" A 72 DENTI**



1/4"

FG 624/MCH

~~36,80€~~

21,90€

**MINI CRICCHETTO CON ATTACCO
QUADRO FEMMINA 1/4" A 72 DENTI**



- Modello con testa chiusa anti polvere
- Leva di inversione integrata a filo testa
- Corpo scavato di 13° per consentire l'utilizzo anche in spazi particolarmente difficoltosi

- Meccanismo a 72 denti
- Cromatura lucida e asola di aggancio

FG 625/FR12

1/2"

CRICCHETTO REVERSIBILE DA 1/2"

~~57,80€~~

33,90€

FG 624/FR14

1/4"

CRICCHETTO REVERSIBILE DA 1/4"

~~43,50€~~

24,90€



- Sistema di inversione a ghiera integrato sulla testa

- Meccanismo a 72 denti
- Cromatura lucida
- Asola di aggancio

FG 624/CR14

1/4"

**CRICCHETTO REVERSIBILE DA 1/4"
CON IMPUGNATURA BI-MATERIAL**

~~40,80€~~

23,90€

FG 625/CR12

1/2"

**CRICCHETTO REVERSIBILE DA 1/2"
CON IMPUGNATURA BI-MATERIAL**

~~54,80€~~

31,90€



- Sistema di avanzamento rotativo integrato nell'impugnatura

- Meccanismo a 60 denti
- Cromatura lucida e asola di aggancio

FG 624/RT14

1/4"

**CRICCHETTO REVERSIBILE DA 1/4"
CON IMPUGNATURA ROTANTE**

~~65,80€~~

38,90€

FG 625/RT12

1/2"

**CRICCHETTO REVERSIBILE DA 1/2"
CON IMPUGNATURA ROTANTE**

~~82,80€~~

49,90€



FG 624/S29

1/4"

SET 29 UTENSILI DA 1/4"

~~210,00€~~

129,00€

3/8"



4,5,6,7,8,9,10,
11,12,13,14mm



FG 624/CR14



FG 624/PA50, 100



FG 624/PRF150



FG 624/ES14



FG 624/SN14



FG 624/GR14C



FG 624/S45

1/4"

SET 45 UTENSILI DA 1/4"

~~210,00€~~

129,00€



4,5,6,7,8,9,10,
11,12,13,14mm



FG 624/CR14

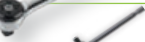

FG 624/ES14



FG 624/PA50, 100



FG 624/PRF150



FG 624/SN14



FG 624/GR14C



FG 148/H, FG 148/TX, 1.5-10, 8-40,
FG 148/PH, FG 148/F 1-4, 1-5



FG 624/S25A

1/4"

**SET 25 UTENSILI CON
ATTACCO QUADRO 1/4"**

~~85,00€~~

49,90€

FG 624/E: 5, 6, 8, 10, 11, 13mm



FG 624/MCH14



ADATTATORE 1/4"x1/4"



FG 85/25PH1, PH2, PH3



FG 85/25PZ1, PZ2, PZ3



FG 85/25F3, F5



FG 85/25H4, H5, H6



FG 85/25TX10, TX15, TX20, TX25, TX30, TX40



FG 624/S25

1/4"

**SET 25 UTENSILI
CON ATTACCO QUADRO 1/4"**

~~90,00€~~

49,90€



FG 624/E: 6, 8, 10, 11, 12, 13mm



FG 624/CR14



FG 89/38P11 (1/4x1/4)



FG 85/25PH1, PH2, PH3



FG 85/25PZ1, PZ2, PZ3



FG 85/25F4, F5, F6, F7



FG 85/25TX10, TX15, TX20, TX25, TX30, TX40

CHIAVI A BUSSOLA



FG 625TX/S13

SET 13 CHIAVI A BUSSOLA SNODATE CON IMPRONTA TORX

CONTENUTO:

1/4": E4, E5, E6, E7, E8

3/8": E10, E12, E14, E16

1/2": E18, E20, E22, E24

~~160,00€~~ **69,00€**

1/4"

3/8"

1/2"



FG 624B/TXS10 3/8"

SET 10 CHIAVI A BUSSOLA EXTRA-LUNGHE TORX

CONTENUTO: E6, E7, E8, E10, E11, E12, E14, E16, E18, E20

~~135,00€~~ **49,00€**



FG 624B/S80

~~200,00€~~ **99,00€**

SET 80 UTENSILI DA 3/8"

3/8"

	FG 624/B8,9,10,11,12,13,14,15,16,17,18,19,21,22,23
	FG 624B/L8,10,13,14,17,19
	FG 624/CR38
	FG 625/SN38
	FG149/H 3,4,5,6,7,8,10 FG 149/TX 9,10,15,20,25,27,30,40
	FG 624/ES38
	FG 624B/PA75,125,150,250
	FG 600B/8,10,13,15,17,19
	FG 89/50PI2 3/8"x1/4"
	FG 85/25PH 1,2,3 FG 85/25PZ 1,2,3 FG 85/25SL 3,4,4,5,5,5,5,6,6,5 FG 85/H 1,5,2,2,5,3,4,5,6 FG 85/25T 9,10,15,20,25,27,30,40 FG 88/60PI2

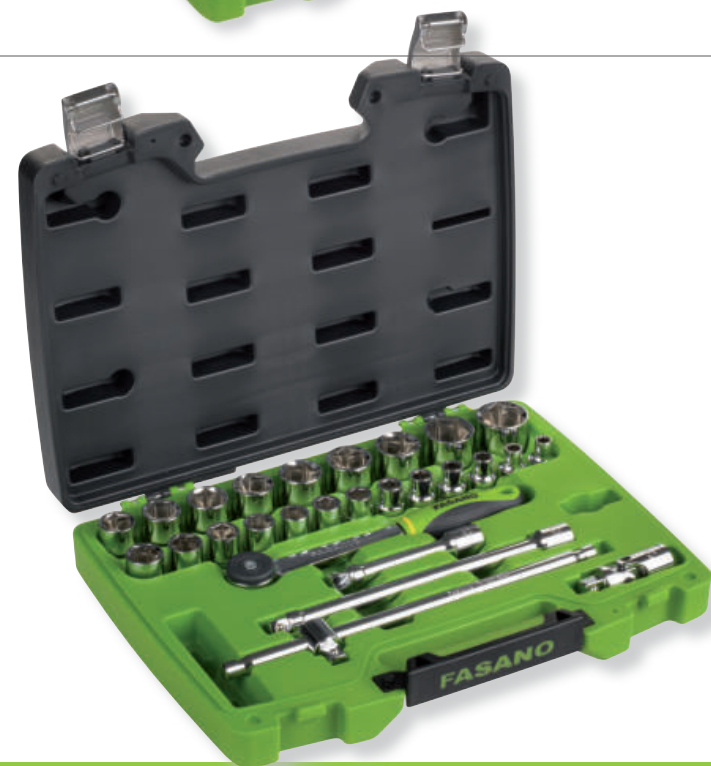

FG 625/S27

~~190,00€~~ **99,00€**

SET 27 UTENSILI DA 1/2"



1/2"

	FG 625/A8,9,10,11,12,13,14,15,16,17,18,19,20,21,22,23,24,25,26,27,30,32
	FG 625/CR12
	FG 625/SN12
	FG 625/ES12
	FG 625/PA125, 250

FG BEST 108

1/4"

1/2"



FG BEST 108

~~270,00€~~

139,00€

SET 108 UTENSILI DA 1/4" 1/2"

	FG 625/A10,11,12,13,14,15,16,17,18,19,20,21,22,23,24,27,30,32		FG 87/AD
	FG 624/E4,4.5,5.5,6,7,8,9,10,11,12,13,14		FG 181/B16,21 x CANDELE ACCENSIONE
	FG 625L/A14,15,17,19,22		FG 624/CR14 FG 625/CR12
	FG 624E/L6,7,8,9,10,11,12,13		FG 625/SN12 FG 624/SN14
	FG 625/TX10,11,12,14,16,18,20,24		FG 625/ES12 FG 624/ES14
	FG 624/TX4,5,6,7,8		FG 624/GR14
	FG 139/D1.5,2,2.5		FG 625/PR125 FG 624/PR50,100
	FG 147/PH1,PH2 FG 147/PZ1,PZ2 FG 147/SL4,SL5.5,SL6.5 FG 147/H3,H4,H5,H6 FG 147/TX10,TX15,TX20,TX25,TX30		
	FG 85/PH3,PH4 FG 85/PZ3,PZ4 FG 85/SL8,SL10,SL12 FG 85/H7,H8,H10,H12,H14 FG 85/TX40,TX45,TX50,TX55,TX60		

FG BEST 171

1/4"

3/8"

1/2"



FG BEST 171

~~400,00€~~

189,00€

SET 171 UTENSILI DA 1/4", 3/8" E 1/2"

	FG 625/A10,11,12,13,14,15,16,17,18,19,20,21,22,23,24,27,30,32		FG 87/AD
	FG 624/B10,11,12,13,14,15,16,17,18,19		FG 181/B16,21 x CANDELE ACCENSIONE
	FG 624/E4,4.5,5.5,6,7,8,9,10,11,12,13,14		FG 625/SN12 FG 624/CR38 FG 624/SN14
	FG 625L/A16,17,18,19,22 FG 624B/L10,11,12,13,14,15 FG 624/4,5,6,7,8,9,10		FG 625/ES12 FG 624/ES14
	FG 625/TX20,24 FG 624B/TX10,11,12,14,16,18 FG 624/TX4,5,6,7,8		FG 624/GR14
	FG 181/B16,21 x CANDELE ACCENSIONE		FG 625/PR125 FG 624B/PR125 FG 624/PR50,PR100
	FG 624/CR14 FG 624/CR38 FG 625/CR12		FG 139/D1.1,1.5,2,2.5,3,4,4.5,5
	FG 147/PH0,PH1,PH2 FG 147/PZ0,PZ1,PZ2 FG 147/SL4,5.5,6.5,7 FG 147/H3,H4,H5 FG 147/TX8-TX30 FG 147/RTX8-RTX30		
	FG 85/PH3,PH4 FG 85/PZ3,PZ4 FG 85/SL8,SL10,SL12 FG 85/H7,H8,H10,H12,H14 FG 85/TX40-TX50 FG 85/TT10-TT45 FG 85/M5-M9		

CHIAVI A BUSSOLA

FG 625/S74

~~250,00€~~

129,00€

SET 74 UTENSILI CON AGGANCIO 1/4" E 1/2"



1/4"

1/2"



FG 625/A8,9,10,11,12,13,14,15,16,17,18,19,20,21,22,23,24,25,26,27,30,32



FG 624/E4,5,6,7,8,9,10,11,12,13,14



FG 624/CR14
FG 625/CR12



FG 625/SN12
FG 624/SN14



FG 625/ES12
FG 624/ES14



FG 624/GR14C



FG 625/PA125
FG 624/PA50, 100



FG 89/38PI1 1/4"x1/4"



FG 85/25PH1, PH2, PH3
FG 85/25SL3, SL4, SL4.5, SL5, SL5.5, SL6, L6.5
FG 85/25PZ1, PZ2, PZ3
FG 85/H1.5, H2, 2.5, H3, H4, H5, H6
FG 85/25T9, T10, T15, T20, T25, T27, T30, T40

FG 625/S94

~~300,00€~~

149,00€

SET 94 UTENSILI CON AGGANCIO 1/4" E 1/2"



1/4"

1/2"



FG 625/A8,9,10,11,12,13,14,15,16,17,18,19,20,21,22,23,24,25,26,27,30,32



FG 624/E4,5,6,7,8,9,10,11,12,13,14



FG 625L/A10,13,14,15,17,19



FG 624E/L4,5,6,7,8,9,10,11,12,13,14



FG 624/CR14
FG 625/CR12



FG 625/SN12
FG 624/SN14



FG 625/ES12
FG 624/ES14



FG 624/GR14C



FG 625/PA125, 250
FG 624/PA50, 100



FG 89/38PI1 1/4"x1/4"

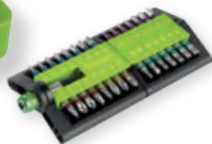

FG 85/25PH1, PH2, PH3
FG 85/25SL3, SL4, SL4.5, SL5, SL5.5, SL6, L6.5
FG 85/25PZ1, PZ2, PZ3
FG 85/H1.5, H2, 2.5, H3, H4, H5, H6
FG 85/25T9, T10, T15, T20, T25, T27, T30, T40
FG 88/60PI2

FG 625/S110

SET 110 UTENSILI DA 1/4" 1/2"

~~470,00€~~

249,00€



1/4"

1/2"



FG 625/A8,9,10,11,12,13,14,15,16,17,
18,19,20,21,22,23,24,25,26,27,30,32



FG 624/E4,5,6,7,8,9,10,11,12,13,14



FG 624/CR14
FG 625/CR12



FG 625/SN12
FG 624/SN14



FG 625/ES12
FG 624/ES14



FG 624/GR14C



FG 625/PA125, 250
FG 624/PA50, 100



FG 89/38PI1 1/4"x1/4"

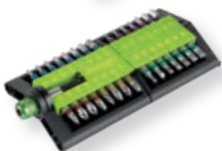

FG 85/25PH1, PH2, PH3
FG 85/25SL3, SL4, SL4.5, SL5, SL5.5, SL6, L6.5
FG 85/25PZ1, PZ2, PZ3
FG 85/H1.5, H2, 2.5, H3, H4, H5, H6
FG 85/25T9, T10, T15, T20, T25, T27, T30, T40
FG 88/60PI2



FG 139/B



FG 48/L



FG 49



FG 600/B8,10,11,12,13,14,15,17,19



FG 22/3x75, 4x100, 5.5x100
FG 22/PH0x60, PH1x80, PH2x100



FG 59SR/160
FG 63SR/160



FG 58/B240



FG 132/H500



FG 79/SP



FG 92/PM1



FG 44/MT5

CHIAVI A BUSSOLA



FG 150TX/S32

~~195,00€~~

119,00€

1/2"

SET 32 INSERTI A BUSSOLA TORX DA 1/2"



FG 150/TX20 - TX70

FG 150L/TX20 - TX70

FG 150XL/TX40 - TX70

FG 150XXL/TX40 - TX70

FG 150M/S26

~~180,00€~~

109,00€

SET 26 INSERTI A BUSSOLA XZN DA 1/2"



1/2"



FG 150/M5 - M16

FG 150L/M5 - M16

FG 150XL/M5 - M14

FG 150XXL/M8 - M14

FG 150H/S30

~~200,00€~~

119,00€

SET 30 INSERTI A BUSSOLA ESAGONALI DA 1/2"

1/2"



FG 150/H5 - H19

FG 150L/H5 - H13

FG 150XL/H5 - H14

FG 150XXL/H5 - H12



FG 629A/S15

3/4"

SET BUSSOLE ESAGONALI DA 3/4" + ACCESSORI

~~600,00€~~

339,00€

19,22,23,27,30,32
36,41,46,50, 60mm

FG 629/CR34

FG 629/SN34

FG 629B/S15

3/4"

SET BUSSOLE POLIGONALI DA 3/4" + ACCESSORI

~~618,00€~~

339,00€

FG 629/ES34

FG 629/PR200



EXTRA-PIATTA

CHIAVI A BUSSOLA 1/2" ESAGONALI RINFORZATE



1/2"

FG 628/S12



SET 12 CHIAVI A BUSSOLA RINFORZATE DA 1/2" SU SUPPORTO IN PLASTICA

CONTENUTO: 10, 11, 12, 13, 14, 15, 16, 17, 18, 19, 20, 21 mm mm

~~130,00€~~ **79,00€**



1/2"

FG 628/S6



SET 6 CHIAVI A BUSSOLA RINFORZATE DA 1/2" SU SUPPORTO IN PLASTICA

CONTENUTO: 22, 23, 24, 27, 30, 32mm

~~95,00€~~ **55,00€**



3/4"

FG 629C/S10



SET 10 CHIAVI A BUSSOLA RINFORZATE ESAGONALI DA 3/4" IN CASSETTA DI ACCIAIO

CONTENUTO: 17, 19, 22, 24, 27, 30, 32, 36, 41, 46mm

~~299,00€~~ **159,00€**



1/2"



FG 152/RTXS10

~~165,00€~~ **99,00€**

SET 10 INSERTI A BUSSOLA RINFORZATI TORX DA 1/2" SU SUPPORTO IN PLASTICA

CONTENUTO: TX20, TX25, TX27, TX30, TX40, TX45, TX50, TX55, TX60, TX70



1/2"



FG 152RM/S9

~~125,00€~~ **69,00€**

SET 9 INSERTI A BUSSOLA XZN RINFORZATI DA 1/2" SU SUPPORTO IN PLASTICA

CONTENUTO: RM5, RM6, RM8, RM9, RM10, RM12, RM14, RM16, RM18



1/2"



FG 152RH/S9

~~125,00€~~ **69,00€**

SET 9 CHIAVI A BUSSOLA RINFORZATE DA 1/2" ESAGONALI SU SUPPORTO IN PLASTICA

CONTENUTO: XZN5, 6, 8, 9, 10, 12, 14, 16, 18



1"

FG 630A/S14

~~830,00€~~ **499,00€**

SET 14 CHIAVI A BUSSOLA ESAGONALI RINFORZATE - ATTACCO 1"

CONTENUTO: 24,27,30,32,33,34,36,38,41,46,50,55,60,65mm



FG 22/S6

CONTENUTO: 3x75, 4x100, 5.5x100,
PH0x60, PH1x80, PH2x100

~~36,80€~~ **21,50€**



FG 22/S8

CONTENUTO: 3x75, 4x100, 5.5x100, 6.5x30
PH0x60, PH1x80, PH2x100, PH2x30

~~48,80€~~ **27,90€**



FG 22/S8B

CONTENUTO: 2.5x75, 3.5x100,
4x100, 6.5x150, 8x150, PH0x60,
PH1x80, PH2x150

~~52,80€~~ **31,90€**



FG 22/S10

CONTENUTO: 2.5x60, 3x75, 4x100,
5.5x150, 6.5x150, 4x30, PH0x60, PH1x80,
PH2x100, PH1x30

~~65,80€~~ **37,90€**



FG 22/S12

CONTENUTO: 2.5x60, 3x75, 4x100, 5.5x150,
6.5x150, 8x150, 4x30, PH0x60, PH1x80,
PH2x100, PH3x150, PH1x30

~~90,80€~~ **53,90€**



FG 22/S7

CONTENUTO: 3x75, 4x100, 5.5x150, 6.5x150,
PZ0x60, PZ1x80, PZ2x100, 3x75, 4x100, 5.5x150,
6.5x150, PZ0x60, PZ1x80, PZ2x100

~~50,80€~~ **29,90€**



FG 22TX/S6

~~65,00€~~ **38,90€**

CONTENUTO: RTX10, RTX15, RTX20, RTX25, RTX27, RTX30



FG 22TX/LS11

~~155,00€~~ **89,00€**

CONTENUTO: TX6, 7, 8, 9, 10, 15, 20, 25, 27, 30, 40



FG 139/B

SET 10 CHIAVI MASCHIO A L ESAGONALI - SERIE CORTA

1,5,2,2,5,3,4,4,5,5,5,6,8,10mm

~~16,50€~~ **9,90€**

FG 139/C

SET 10 CHIAVI MASCHIO A L ESAGONALI - SERIE LUNGA

1,5,2,2,5,3,4,4,5,6,8,10mm

~~23,70€~~ **13,90€**



FG 139

SET 12 CHIAVI MASCHIO A L ESAGONALI - SERIE SFERICA

1,5,2,2,5,3,4,4,5,5,5,6,7,8,10mm

~~36,00€~~ **21,90€**

FG 139/L

SET 12 CHIAVI MASCHIO A L ESAGONALI - SERIE LUNGA

1,5,2,2,5,3,4,4,5,5,5,6,7,8,10mm

~~40,00€~~ **23,90€**

TESTA SFERICA



FG 139C/FS

SET 8 CHIAVI MASCHIO CON IMPRONTA ESAGONALE SFERICA - SERIE CORTA

1,5, 2, 2,5, 3, 4, 5, 6, 8mm

~~24,00€~~ **12,90€**

FG 139FS/IN

SET 9 CHIAVI MASCHIO CON IMPRONTA ESAGONALE - SERIE IN POLLICI

5/64, 3/32, 7/64, 1/8, 9/64, 5/32, 3/16, 7/32, 1/4"

~~24,00€~~ **12,90€**



FG 139/IN

SET 13 CHIAVI MASCHIO A L CON IMPRONTA ESAGONALE SFERICA - IN POLLICI

0,05 - 3/8"

~~38,00€~~ **22,90€**

TESTA SFERICA



FG 138/BP

SET 9 CHIAVI MASCHIO TORX A L E TESTA SFERICA

CONTENUTO:
TX8, 10, 15, 20, 25, 27, 30, 40, 50

~~60,00€~~ **35,90€**

TESTA SFERICA



FG 138

SET 12 CHIAVI MASCHIO TORX A L

CONTENUTO:
TX7, X8, 9, 10, 15, 20, 25, 27, 30, 40, 45, 50

~~55,00€~~ **29,90€**



FG 139/LM

SET 10 CHIAVI MASCHIO A L ESAGONALI MAGNETICHE

CONTENUTO: 1.5, 2, 2.5, 3, 4, 5, 6, 7, 8, 10mm

~~52,00€~~ **30,90€**

ESTREMITÀ MAGNETICA



FG 138/M

SERIE 10 CHIAVI MASCHIO A L TORX MAGNETICHE

CONTENUTO: TX9 - TX50

~~60,00€~~ **35,90€**

ESTREMITÀ MAGNETICA



FG 138/B

SET 10 CHIAVI MASCHIO A L CON IMPRONTA TORX

CONTENUTO: TX9 - TX50 - SERIE CORTA

~~34,00€~~ **16,90€**

FG 138/C

SET 10 CHIAVI MASCHIO A L CON IMPRONTA TORX

CONTENUTO: TX9 - TX50 - SERIE LUNGA

~~37,00€~~ **19,90€**

NEW



FG 85/S100

SET 98 INSERTI DA 1/4" + 2 PORTA INSERTI

CONTENUTO:
PH 0, 1, 2, 3; PZ 0, 1, 2, 3; Tri-Wing 1, 2, 3, 4, 6, 8, 10; XZN 5, 6, 8; TX 8, 9, 10, 15, 20, 25, 27, 30, 40, 45; S 0, 1, 2, 3; TX 8, 10, 15, 20, 25, 27, 30, 35, 40; SL 3, 4, 4.5, 5, 5.5, 6, 6.5, 7; H 1.5, 2, 2.5, 3, 4, 5, 5.6, 1/16, 5/64, 3/32, 7/64, 1/8, 9/64, 5/32, 3/16, 7/32, 1/4; HTR 2, 2.5, 3, 4, 5, 6, 5/64, 3/32, 7/64, 1/8, 9/64, 4, 5/32; SP 4, 6, 8, 10; SP 5/32, 3/16, 1/4



~~98,00€~~ **59,00€**

FG 56/S3
~~89,30€~~ **53,90€**
SET 3 PINZE A BECCHI LUNGI ZIGRINATI -L: 270MM
CONTENUTO: FG 56/0, FG 56/45, FG 56/90
FG 57/S3
~~116,80€~~ **69,90€**
SET 3 PINZE A BECCHI LUNGI ZIGRINATI -L: 270MM
CONTENUTO: FG 57/0, FG 57/45, FG 57/90

FG 58/A240
PINZA REGOLABILE A CERNIERA CHIUSA CON PULSANTE DI SGANCIO RAPIDO
~~42,80€~~ **24,90€**

FG 58/B...
PINZA REGOLABILE A CERNIERA CHIUSA SEMPLICE

CODICE	MM - INCH	LISTINO	€/PROMO
FG 58/B180	180-7"	29,00	16,90
FG 58/B240	240-10"	33,50	19,90
FG 58/B300	300-12"	47,00	27,90

FG 59XT/S3
~~89,50€~~ **49,90€**
SET 3 PINZE ASSORTITE
CONTENUTO: FG 59/XT180, FG 61/XT160, FG 63/XT160
FG 59XT/S3B
~~99,50€~~ **58,90€**
SET 3 PINZE ASSORTITE
CONTENUTO: FG 59/XT180, FG 61/XT200, FG 63/H180

FG 59PV/S3
~~72,80€~~ **39,90€**
SET 3 PINZE, CON MANICI IN DOPPIO STRATO DI PVC
CONTENUTO: FG 59PV/160, FG 61PV/160, FG 63PV/160
FG 59PV/S3B
~~79,80€~~ **44,90€**
SET 3 PINZE, CON MANICI IN DOPPIO STRATO DI PVC
CONTENUTO: FG 59PV/180, FG 61PV/200, FG 63PV/H180

FG 51/S4
~~99,80€~~ **55,90€**
SET 4 PINZE PER ANELLI ELASTICI 10-25MM
FG 51/S4B
~~105,80€~~ **61,90€**
SET 4 PINZE PER ANELLI ELASTICI 19-60MM
"INSERTI RINFORZATI PER ANELLI DI GRANDE TENUTA"

FG 55/S4
~~136,50€~~ **76,00€**
SET 4 PINZE PER ANELLI ELASTICI CON INSERTI RINFORZATI IN ACCIAIO 10-25MM
FG 55/S4B
~~141,80€~~ **79,90€**
SET 4 PINZE PER ANELLI ELASTICI CON INSERTI RINFORZATI IN ACCIAIO 19-60MM



FG 22E/S6

SET 6 GIRAVITI ISOLATI

CONTENUTO: 3X100, 4X100, 5.5X125, PH0X60, PH1X80, PH2X100



~~58,00€~~ **33,90€**



FG 22E/SZ6

SET 6 GIRAVITI ISOLATI

CONTENUTO: 3x100, 4x100, 5.5x125 PZ0x60, PZ1x80, PZ2x100

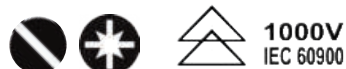

~~58,00€~~ **33,90€**



FG 59IS/S3

SET 3 PINZE CON MANICI ISOLATI

CONTENUTO: FG 59/IS180, FG 61/IS200, FG 63/IS160



~~118,50€~~ **62,90€**



FG 68U/S439

SET PINZA UNIVERSALE + 3 MATRICI (FG 68/MAT4, MAT16, MAG) CON ASSORTIMENTO 435 CAPICORDA ISOLATI

~~228,00€~~ **169,00€**



FG 96/DG
~~185,00€~~
109,00€
MULTIMETRO DIGITALE DC/AC - OHM

CARATTERISTICHE TECNICHE:

Classe II
 Categoria sovratensione: CAT III 300V
 Test di continuità
 Frequenza: 10Hz-200kHz
 Prova diodi
 Duty cycle 5%-95% RH ($\pm 0.1\%$)
 Temperatura -20°C/400°C ($\pm 1.5\% \pm 3.0^\circ\text{C}$)
 / 400°C/1000°C ($\pm 2.0\% \pm 3.0^\circ\text{C}$)
 Misurazione Lux 4.000 Lux (± 1) / 40.000 Lux (± 10)
 Capacità rilevazione umidità 30%-90% RH ($\pm 0.1\%$)
 Capacità di rilevazione suono 35 - 100dB ($\pm 0.1\text{dB}$)
 Stand by dopo 15 minuti
 Indicatore di livello batteria
 Batteria da 9 V



DC	AC	Ω	LXPXH/MM
400mV-300V	4V-300V	400 Ω -40M Ω	8x3.5x16.5

FG 97/DG
~~135,00€~~
79,00€
MULTIMETRO DIGITALE DC/AC - OHM

CARATTERISTICHE TECNICHE:

Classe II
 Categoria sovratensione: CAT III 600V
 Prova diodi
 Alimentazione: 1 batteria tipo AAA da 1.5V

NEW

DC	AC	Ω	LXPXH/MM
600mV-600V	6V-600V	600 Ω -60M Ω	148x76x21

FG 98/DG
~~340,00€~~
199,00€
MULTIMETRO DIGITALE DC/AC - OHM

CARATTERISTICHE TECNICHE:

Classe II
 Categoria sovratensione: CAT IV 600V; CAT III 1000V
 Frequenza: 100 kHz
 Prova diodi
 Alimentazione: 1 batteria da 9V

NEW

DC	AC	Ω	LXPXH/MM
200mV-1000V	2V-750V	200 Ω -20M Ω	184x90x46

FG 99/DG
~~250,00€~~
149,00€
PINZA AMPEROMETRICA DIGITALE

CARATTERISTICHE TECNICHE:

Classe II
 Categoria sovratensione: CAT III 600V
 Temperatura: -20°C ÷ 1000°C (-4°F ÷ 1832°F)
 Frequenza: 10Hz; 100Hz; 1000Hz; 10kHz; 100kHz;
 1000kHz; 10MHz
 Prova diodi
 Alimentazione: 3 batterie da 1.5V TIPO AAA

NEW

DC	AC	Ω	LXPXH/MM
600mV-600V	6V-600V	600 Ω -60M Ω	194x59x29



CHIAVI DINAMOMETRICHE A DISINNESTO E ATTACCO QUADRO
Fornita con certificato di taratura

CODICE	RISOLUZIONE	NM	LISTINO	€/PROMO	
FG 531	0.1Nm	5-25Nm	215,00	125,00	1/4"
FG 533/2	0.25Nm	10-50Nm	240,00	139,00	3/8"
FG 536/1	0.5Nm	20-100Nm	240,00	139,00	1/2"
FG 536/2	1.0Nm	40-200Nm	250,00	145,00	1/2"
FG 536/3	2.0Nm	60-340Nm	265,00	159,00	1/2"
FG 540/1	2.5Nm	150-750Nm	1.050,00	629,00	3/4"
FG 540/2	2.5Nm	200-1.000Nm	1.200,00	719,00	3/4"



CHIAVE DINAMOMETRICA A INNESTO FEMMINA 9X12MM
Precisione $\pm 4\%$
Fornita con certificato di taratura

CODICE	RISOLUZIONE	NM	□ x ■	LISTINO	€/PROMO
FG 544/1	0.1Nm	5-25Nm	9x12	195,00	119,00
FG 544/2	0.25Nm	10-50Nm	9x12	216,00	129,00
FG 544/3	0.5Nm	20-100Nm	9x12	232,00	139,00
FG 544/4	1.0Nm	40-200Nm	14x18	278,00	159,00



BARRE DINAMOMETRICHE A DISINNESTO E ATTACCO QUADRO
Fornita con certificato di taratura

CODICE	NM	LISTINO	€/PROMO	
FG 538/1	140-560	800,00	469,00	3/4"
FG 538/2	200-800	800,00	529,00	3/4"
FG 539/1	200-1.000	1.150,00	679,00	1"

GRADO DI PRECISIONE: $\pm 4\%$ FORNITA IN CASSETTA DI ABS

**CHIAVI DINAMOMETRICHE
DIGITALI PER NM E GRADI**
Fornita con certificato di taratura

1/2"

CODICE	NM	LISTINO	€/PROMO
FG 543/DG1	16.8-135	650,00	389,00
FG 543/DG2	10-200	770,00	459,00

- Doppia modalità di misurazione: PICCO e TRACCIA
- Indicatore sonoro e visivo a 12 led al raggiungimento della coppia prefissata
- Possibilità di memorizzare fino a 250 differenti serraggi grazie al software PC incluso nel kit Interfaccia PC tramite presa USB
- Possibilità di impostare fino a 9 serraggi predefiniti
- Alimentazione: 2 batterie 1.5V (incluse)



FG 546/DG

~~320,00€~~ 195,00€

**GONIOMETRO DIGITALE PER
SERRAGGI IN COPPIA E ANGOLARI**

PRECISIONE DI SERRAGGIO: ± 2%

- Doppia modalità di misurazione: PICCO e TRACCIA
- Indicatore sonoro e visivo a 6 led al raggiungimento della coppia prefissata
- Possibilità di memorizzare fino a 50 serraggi differenti
- Alimentazione: 2 batterie 1.5V (incluse)



FG 547/DG

~~205,00€~~ 125,00€

**GONIOMETRO DIGITALE
PER SERRAGGI ANGOLARI**

PRECISIONE DI SERRAGGIO: ± 2%

- Indicatore sonoro e visivo a 6 led al raggiungimento della coppia prefissata
- Dotato di supporto magnetico posteriore

**MINI MOLTIPLICATORE DI COPPIA
DESTROSO/SINISTROSO**

1/2" x 1/2"
Rapporto: 3.4:1



CODICE	NM	MASSIMA USCITA	LISTINO	€/PROMO
FG 580/A	445	600	270,00	99,00
FG 580/B	590	800	370,00	129,00

**GIRAVITE DINAMOMETRICO
A TARATURA LIBERA**



1/4"

CODICE	NM	L/MM.	LISTINO	€/PROMO
FG 559/1	0.1- 1.2	155	220,00	125,00
FG 559/2	1 - 6	155	230,00	135,00

PRECISIONE DI SERRAGGIO: ± 6%



FG 70/S110

~~335,00€~~ 199,00€

SET MASCHI E FILIERE IN ACCIAIO AL CROMO + ACCESSORI - 110PZ
PASSO GROSSO E FINE - FILETTATURA METRICA

						ACCESSORI
2x.04	6x0.75	12x1	2x0.4	6x0.75	12x1	GF25x9
3x0.5	7x0.75	12x1.25	3x0.5	7x0.75	12x1.25	GF8x14
4x0.7	8x0.75	12x1.5	4x0.7	8x0.75	12x1.5	GMM1.5
5x0.8	8x1	14x1	5x0.8	8x1	14x1	GMM3
6x1	9x0.75	14x1.25	6x1	9x0.75	14x1.25	GMC1
7x1	9x1	14x1.5	7x1	9x1	14x1.5	
8x1.25	10x0.75	16x1	8x1.25	10x0.75	16x1	
9x1.25	10x1	16x1.5	9x1.25	10x1	16x1.5	
10x1.5	10x1.25	18x1.5	10x1.5	10x1.25	18x1.5	
11x1.5	11x0.75		11x1.5	11x0.75		
12x1.75	11x1		12x1.75	11x1		
14x2	11x1.25		14x2	11x1.25		
16x2	12x0.75		16x2	12x0.75		



FG 75TIN/S25

SET 25 PUNTE ELICOIDALI CILINDRICHE IN ACCIAIO HSS -TIN 5% RETTIFICATE
1 - 13 X0,5MM

~~198,00€~~ 119,00€



FG 75CO/S25

SET 25 PUNTE ELICOIDALI CILINDRICHE IN ACCIAIO HSS -COBALTO 5% RETTIFICATE
1 - 13 X0,5MM

~~236,00€~~ 139,00€



FG 80HSS/S3

SET 3 FRESE CONICHE IN ACCIAIO HSS
APPLICAZIONE: LAMIERE D'ACCIAIO
FORNITO IN BOX DI ABS DOTATO DI GANCIO DI APPENDIMENTO

~~145,00€~~ 89,00€

FG 49/L

~~18,00€~~ **10,90€**

FORBICE MULTIUSO A LAME LUNGHE IN ACCIAIO INOX

L/MM 200
APERTURA MAX 151MM
HRC: 52-54



FG 49/MU

~~26,50€~~ **15,90€**

FORBICI MULTIUSO CON GOLA SPELLAFILI E LAME IN ACCIAIO INOX ZIGRINATE

HRC: 52-54



FG 49/TC

~~41,00€~~ **24,90€**

FORBICE DA ELETTRICISTA, DOTATA DI INCAVO SPELLAFILI E CORPO INTEGRALMENTE IN ACCIAIO

L/MM 140 - A/MM 65MM
- LAMA MICRODENTATA IN ACCIAIO
- HRC: 56
- STRUTTURA INTEGRALE IN ACCIAIO INOX
- TAGLIACAVI 12MM
- CON SUPPORTO PER CINTURA



STRUTTURA INTERAMENTE IN ACCIAIO FORGIATO



FG 49/TCX

~~48,00€~~ **28,90€**

FORBICE DA ELETTRICISTA, DOTATA DI INCAVO SPELLAFILI E CORPO INTEGRALMENTE IN ACCIAIO

L/MM 160 - A/MM 50MM
- LAMA MICRODENTATA IN ACCIAIO
- HRC: 56
- STRUTTURA INTEGRALE IN ACCIAIO INOX
- TAGLIACAVI 15MM
- CON SUPPORTO PER CINTURA



STRUTTURA INTERAMENTE IN ACCIAIO FORGIATO



FG 77/PVC4

~~70,00€~~ **29,00€**

TRONCATUBI A CRICCO

- SISTEMA A CREMAGLIERA CON AVANZAMENTO PROGRESSIVO
- DOTATA DI PIATTAFORMA IN NYLON CHE FACILITA IL TAGLIO DI PROFILI PIATTI
- Ø: 0-42MM

TUBO IN PVC



TRONCABULLONI

CODICE	L/MM-POLLICI	CAPACITA'	LISTINO	€/PROMO
FG 67/350	350-14"	3-10mm	48,00	29,00
FG 67/450	450-18"	5-16mm	61,00	36,90
FG 67/600	600-24"	8-22mm	82,50	49,90
FG 67/750	750-30"	9-25mm	107,00	64,90



MANUTENZIONE GENERALE



FLESSOMETRO CON CASSA IN ABS ANTI-SHOCK E NASTRO IN ACCIAIO RIVESTITO IN NYLON - CLASSE II

CODICE	L/MM	BANDA	LISTINO	€/PROMO
FG 44/MT3	3	16MM	11,50	6,90
FG 44/MT5	5	25MM	18,00	10,90
FG 44/MT8	8	25MM	24,00	13,90
FG 44/MT10	10	25MM	29,00	16,90

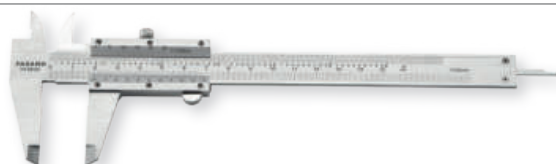

CALIBRO A CORSOIO, LETTURA CINQUANTESIMALE
SCALA CROMATA - ASTA SOTTILE - BLOCCAGGIO A VITE - INOX TEMPRATO

CODICE	L/MM	LISTINO	€/PROMO
FG 95/CA	150	52,00	29,90
FG 95/CA2	200	125,00	69,00



CALIBRO DI PROFONDITÀ, LETTURA CINQUANTESIMALE
SCALA CROMATA - ASTA SOTTILE - BLOCCAGGIO A VITE - INOX TEMPRATO

FG 95/CP1 ~~96,00€~~ **59,00€**



CALIBRO A CORSOIO, DIGITALE
- L/MM: 150

FG 95/DG ~~95,00€~~ **55,00€**



MARTELLO TIPO TEDESCO CON MANICO IN RESINA

CODICE	gr	L/mm	LISTINO	€/PROMO
FG 132/200	200	294	18,50	10,90
FG 132/300	300	297	20,50	11,90
FG 132/500	500	312	21,50	12,90
FG 132/800	800	342	27,00	15,90
FG 132/1000	1000	343	29,50	17,90

FG 127/S1
SET SCALPELLI E PUNZONI



~~49,50€~~ **28,90€**

FG 128C/S6
SET 6 CACCIASPINE
- MISURE: 2,3,4,5,6,8MM



~~46,50€~~ **27,90€**

FG 128P/S6
SET 6 PUNZONI
- MISURE: 1,2,3,4,5,6MM



~~41,50€~~ **24,90€**

FG 712/L4
PORTA MINUTERIE A RIPIANI GIREVOLI
- FORNITO CON DIVISORI INTERNI
- DOTATO DI 4 RIPIANI GIREVOLI E VASCHETTA SUPERIORE PORTA MINUTERIE
- MATERIALE: ABS RESISTENTE AGLI URTI
- DOTATO DI 4 PIEDI D'APPoggio



~~120,00€~~ **49,00€**



FG 47/S3
SET 3 RASCHIETTI
A BATTERE CON LAMA
IN ACCIAIO INOX

~~58,00€~~ **34,90€**



FG 47/S4
SET 4 SPATOLE
IN ACCIAIO INOX

~~21,50€~~ **12,90€**

FG 92/PM4 ~~27,50€~~ **12,90€**
PROLUNGA MAGNETICA
TELESCOPICA (165-622MM)



FG 92/GR
PROLUNGA MAGNETICA FLESSIBILE
- CAPACITÀ 1KG - LUNGHEZZA: 700MM



CON GRIFFE PRENSILI

~~27,00€~~ **14,90€**

FG 92/PF ~~27,50€~~ **13,90€**
PROLUNGA MAGNETICA CON ASTA FLESSIBILE
CAPACITÀ 3.5KG

LUNGHEZZA
ASTA: 400MM



1 metro

ASTA
DA 1 METRO

FG 92/PM
PROLUNGA MAGNETICA
CON ASTA FLESSIBILE

~~19,00€~~ **11,50€**



MANUTENZIONE GENERALE

CE



FG 98/GAS

SALDATORE PORTATILE A GAS

- TEMPERATURA MAX: 210-450°C
- 25 WATT
- AUTONOMIA: 120 MIN CONTINUATIVI
- FORNITO CON PUNTE PER SALDARE, TAGLIARE E SOFFIARE

~~125,00€~~ **75,00€**

CE



FG 98/LT

SALDATORE PORTATILE CON BATTERIA AL LITIO

- TEMPERATURA MAX: 600°C
- AUTONOMIA: 40MIN CONTINUATIVI
- TEMPO DI RICARICA: 3.5H
- FORNITO CON PUNTE PER SALDARE, TAGLIARE E SOFFIARE

~~170,00€~~ **99,00€**

FG 96/SS36

~~65,00€~~ **39,00€**

SALDATORE A STILO A DOPPIA POTENZA
CLASSE DI PROTEZIONE I



NEW

FG 96/SS30

SALDATORE A STILO

- 30 WATT - 230V - Ø/mm 4 - 430 °C
- CLASSE DI PROTEZIONE: I

~~48,00€~~ **29,90€**



CE

FG 95/SP100

SALDATORE ISTANTANEO A PISTOLA 100W
CLASSE DI PROTEZIONE II
FORNITO CON 1 PUNTA DI RICAMBIO E STAGNO PER SALDARE



~~65,00€~~ **39,00€**

FG 96/SS60

SALDATORE A STILO

- 60 WATT - 230V - Ø/mm 6 - 500 °C
- CLASSE DI PROTEZIONE: I

~~60,00€~~ **36,00€**

FG 494/S12

PISTOLA PER COLLA A CALDO

- KIT COMPLETO DI 12 STICK
DI COLLA TERMOFUSIBILE

~~55,00€~~ **32,90€**



- POTENZA NOMINALE DI RISCALDAMENTO: 80W
- TEMPERATURA DI ESERCIZIO: 193°C (383°F)
- TEMPO DI RISCALDAMENTO: 3/5 MIN
- LUNGHEZZA STICK COLLA: 200MM
- DIAMETRO STICK COLLA: 11.5MM



FG 93/M50

**SPECCHIETTO TELESCOPICO
E ARTICOLATO IN ACCIAIO**



~~30,00€~~ **17,90€**

FG 93/M95

**SPECCHIETTO TELESCOPICO
E ARTICOLATO IN ACCIAIO**



~~30,00€~~ **17,90€**



FG 125/S3

**SET 3 LEVE IN ACCIAIO
CON TESTA A BATTERE**

CONTENUTO: 300, 450, 600MM

~~68,00€~~ **39,90€**

PISTOLA A LEVA PER GRASSO

UTILIZZABILE CON GRASSO IN CARTUCCIA E GRASSO SFUSO
DOTATA DI CANNUCCIA RIGIDA E TUBO FLESSIBILE Ø 53MM



CODICE	CAPACITA' CC	L/mm TUBO	LISTINO	€/PROMO
FG 490/C500	500CC	320	52,00	31,20
FG 490/C800	800CC	500	65,00	39,00

FG 493/AL



PISTOLA PER SIGILLANTE CON TUBO IN ACCIAIO

CORPO PRINCIPALE E MECCANISMO
INTERNO INTERAMENTE IN ACCIAIO

~~45,00€~~ **26,90€**

FG 493/N

**PISTOLA PER SIGILLANTE
CON TUBO IN ALLUMINIO**

- DOTATA DI FUNZIONE
ANTI-GOCCIA



~~38,50€~~ **23,50€**

FG 79/SP3

SPAZZOLA CON FILI RIGIDI IN ACCIAIO

~~5,50€~~ **3,30€**



FG 79/SP4

SPAZZOLA CON FILI IN ACCIAIO ONDULATO OTTONATO

~~5,30€~~ **3,20€**



FG 203

MINI FARETTO PORTATILE A LED

DOTATO DI MAGNETI POSTERIORI, FUNZIONE DI GESTIONE DELL'INTENSITA', DOPPIA PORTA PER RICARICA. INCLUSO CAVO DI RICARICA USB. CORPO IN ALLUMINIO ANODIZZATO
FUNZIONE DIMMER



BASE MAGNETICA



DOPPIA PORTA DI RICARICA TIPO C E MICRO USB

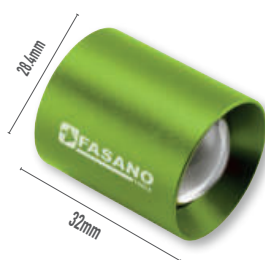

100 LUMEN

~~25,00€~~

12,90€

FG 204

MINI LAMPADA PORTATILE A LED
BATTERIA AL LITIO LUNGA DURATA



300 LUMEN



DOTATA DI SISTEMA MAGNETICO



~~31,50€~~

18,90€

FG 205

LAMPADA PORTATILE A LED

DOTATA DI LED SUPERIORE, GANCIO ESTRAIBILE, BASE D'APPoggio MAGNETICA E ROTANTE FINO A 180°. INCLUSO CAVO DI RICARICA USB TIPO C.



LED SUPERIORE



GANCIO ESTRAIBILE

420 LUMEN

~~85,00€~~

49,90€

FG 202

NEW

LAMPADA RICARICABILE A LED CON TSC SYSTEM

LED DI PUNTAMENTO SUPERIORE
TSC SYSTEM, TECNOLOGIA DI SPEGNIMENTO AUTOMATICO AL CONTATTO CON SUPERFICI
CORPO IN ALLUMINIO ANODIZZATO
DOPPIO MAGNETE, SULLA BASE E SUL RETRO
GANCIO PER CINTURA
CAVO USB TIPO C IN DOTAZIONE



CE 1.200 LUMEN

~~55,00€~~ **32,90€**



LED DI PUNTAMENTO SUPERIORE



TSC SYSTEM

FG 222/A

NEW

LAMPADA RICARICABILE A LED CON CASSE WIRELESS

LED DI PUNTAMENTO SUPERIORE
DOPPIA CASSA WIRELESS DA 5W
GANCIO CON MAGNETI INTEGRATI, ESTRAIBILE ED ORIENTABILE A 180°, PER APPENDERE O APPOGGIARE LA LAMPADA
GRADO DI RESISTENZA AD ACQUA E POLVERI IP54
CAVO USB TIPO C IN DOTAZIONE



CE 500 LUMEN

~~120,00€~~ **69,00€**



LED DI PUNTAMENTO SUPERIORE A 160 LUMEN



GANCIO ESTRAIBILE ED ORIENTABILE FINO A 180°

FG 213/L480

LAMPADA DA TESTA A DOPPIO LED CON SENSORE ON/OFF CONTACTLESS

480 LUMEN



CE



SENSORE ON/OFF CONTACTLESS



4 LIVELLI DI INCLINAZIONE



~~65,00€~~ **39,90€**

FG 206

LAMPADA RICARICABILE A LED

DESIGN SLIM
MAGNETI SUL RETRO
GANCIO PER APPENDERE LA LAMPADA
GRADO DI PROTEZIONE IPX4
CAVO MICRO USB IN DOTAZIONE



CE

360 LUMEN

~~55,00€~~ **32,90€**



FG 207

LAMPADA RICARICABILE A LED

LED DI PUNTAMENTO SUPERIORE
PIVOTANTE A 180°
BASE MAGNETICA
INDICATORE STATO DI CARICA
GRADO DI RESISTENZA AD ACQUA E POLVERI IP54
CAVO USB TIPO C IN DOTAZIONE



300 LUMEN



CE

~~65,00€~~ **35,90€**

FG 207/B

NEW

LAMPADA RICARICABILE A LED

LED DI PUNTAMENTO SUPERIORE
PIVOTANTE A 180°
BASE MAGNETICA
INDICATORE STATO DI CARICA
GRADO DI RESISTENZA AD ACQUA E POLVERI IP54
CAVO USB TIPO C IN DOTAZIONE

700 LUMEN

CE



PIVOTANTE
FINO A 180°



GIREVOLE
FINO A 180°



~~98,00€~~ 59,90€

FG 210/A

~~90,00€~~ 49,90€

MINI FARETTO PORTATILE A LED 700 LUMEN

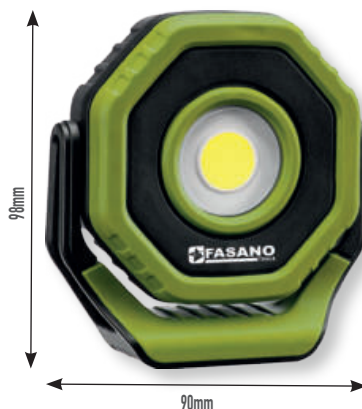

90mm



CE



1.200 LUMEN

FG 208

~~230,00€~~ 119,00€

LAMPADA SOTTO COFANO RICARICABILE A LED



CE

LUNGHEZZA REGOLABILE:
1.300-2.060MM



LAMPADA PORTATILE
INTEGRATA E REMOVIBILE



DOTATA DI SISTEMA
MAGNETICO



1.200 LUMEN

FG 209

~~265,00€~~ 149,00€

LAMPADA SOTTOCOFANO RICARICABILE A LED CON LENTE TRASPARENTE E SEMITRASPARENTE



CE

1200 LUMEN

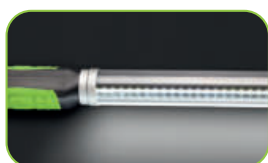

BRIGHT MODE

1100 LUMEN



COMFORTABLE MODE

600 LUMEN



SOFT MODE

INDICATORE DI CARICA



ESTRAIBILE 760MM



FG 210/B

~~85,00€~~ **49,90€**

1200 LUMEN

LAMPADA A TUBO PORTATILE A LED
DOTATA DI LUCE SPOT SUPERIORE, BASE MAGNETICA,
MODALITA' LUCE ROSSA D'EMERGENZA.
INCLUSO CAVO DI RICARICA USB TIPO C.
FUNZIONE DIMMER

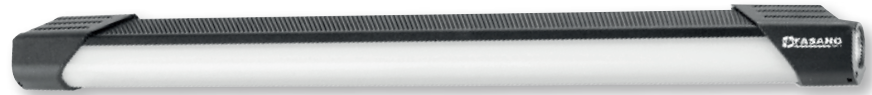

486mm



CE



LUCE FRONTALE BIANCA 1200 LUMEN
LUCE FRONTALE ROSSA 50 LUMEN



SISTEMA DI AGGANCIO
MAGNETICO



RICARICA USB TIPO C



LUCE SPOT 400 LUMEN

FG 211

~~110,00€~~ **59,00€**

LAMPADA RICARICABILE A LED

600 LUMEN



CE

385mm

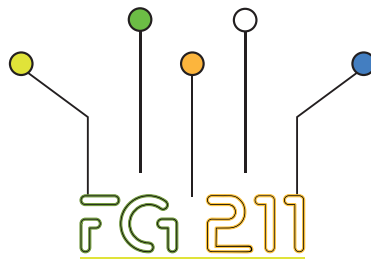

TOP LED DI
PUNTAMENTO



ORIENTABILITÀ
A 360°



REGOLATORE
D'INTENSITÀ



INDICATORE
DI CARICA

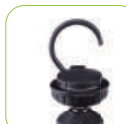

BASE MAGNETICA E
GANCIO ESTRAIBILE

FG 212

~~78,00€~~ **39,90€**

LAMPADA RICARICABILE A LED

200 LUMEN



174mm



CE



FG 214/L600

~~85,00€~~ **39,00€**

TORCIA RICARICABILE A LED

600 LUMEN



CONO LUMINOSO
REGOLABILE



PIASTRA DI SUPPORTO
A PARETE IN DOTAZIONE

CE

FG 217

LAMPADA A 3 FARI LED,
PORTATILE E RICARICABILE
DOTATA DI SUPPORTO TELESCOPICO
REGOLABILE IN ALTEZZA.
INCLUSO CAVO DI RICARICA USB TIPO C.

2.000 LUMEN

~~250,00€~~ **149,00€**



H MAX: 1420mm - H MIN: 665mm



PANNELLO DI CONTROLLO



GANCIO ESTRAIBILE



MAGNETE

CE

FG 210/C

~~165,00€~~ **99,00€**

FARETTO DA LAVORO
RICARICABILE A LED

FUNZIONE POWER BANK (OUTPUT MAX USB 5V 2A)
SUPPORTO ORIENTABILE A 180°
5 LIVELLI DI INDICAZIONE
DELL'AUTONOMIA RESIDUA
GRADO DI RESISTENZA AD ACQUA E POLVERI IP65
GRADO DI RESISTENZA AGLI URTI IK07
INDICE DI RESA CROMATICA CRI 70+
CAVO USB TIPO C IN DOTAZIONE

3.000 LUMEN

NEW



IP 65



FUNZIONE POWER BANK

CE

FG 222/B

~~350,00€~~ **189,00€**

FARO DA LAVORO RICARICABILE
A LED CON CASSE WIRELESS

DOPPIA CASSA WIRELESS DA 10W
FUNZIONE POWER BANK (OUTPUT MAX USB 5V 1A)
CORPO ORIENTABILE A 140°
5 LIVELLI DI INDICAZIONE DELL'AUTONOMIA RESIDUA
GANCIO ESTRAIBILE E GIREVOLE
INTEGRATO NELLA BASE
GRADO DI RESISTENZA AD ACQUA E POLVERI IP65
CARICABATTERIE IN DOTAZIONE

4.000 LUMEN

NEW



CASSE WIRELESS 10W



CORPO ORIENTABILE
A 140°



CE

FG 221

~~340,00€~~ **199,00€**

NEW

**FARO DA LAVORO A DOPPIO
CORPO ILLUMINANTE**

ROTAZIONE ORIZZONTALE DI 180° PER FARO: ILLUMINA
EFFICACEMENTE

DIVERSE AREE DELL'AMBIENTE DI LAVORO

CORPO ORIENTABILE A 90°

BATTERIA AL LITIO ESTRAIBILE DA 14,8V

CON FUNZIONE POWER BANK (OUTPUT MAX USB 5V 2A)

5 LIVELLI DI INDICAZIONE DELL'AUTONOMIA RESIDUA

CARICABATTERIA IN DOTAZIONE

4.500 LUMEN



CE

CORPI ILLUMINANTI
ORIENTABILI FINO A 180°



BATTERIA A LITIO
CON FUNZIONE POWER BANK



FG 224/L5200

~~250,00€~~ **149,00€**

NEW

**FARO DA CANTIERE RICARICABILE A
LED CON LENTE ANTIABBAGLIAMENTO**

SPECIALE LENTE OPACA CHE RIDUCE L'EFFETTO ABBAGLIAMENTO
ED AUMENTA LA DIFFUSIONE DELLA LUCE

SUPPORTO ORIENTABILE A 180° ED AGGANCIABILE AL TREPPIEDI

3 LIVELLI DI INDICAZIONE DELL'AUTONOMIA RESIDUA

GRADO DI RESISTENZA AD ACQUA E POLVERI IP65

GRADO DI RESISTENZA AGLI URTI IK07

CARICABATTERIE IN DOTAZIONE

5.200 LUMEN



ORIENTABILE
FINO A 180°



IP 65

CE



FG 224/SU

~~100,00€~~ **59,00€**

NEW

TREPPIEDI PER FARO DA CANTIERE FG 224/L5200
ALTEZZA MASSIMA 1,60 M



LAMPADE PER CONTROLLO COLORE



LAMPADE PER CONTROLLO COLORE SETTORE CARROZZERIA



FG 234 ~~105,00€~~ **59,00€**

LAMPADA DA TESTA A DOPPIO LED
AD ELEVATO INDICE DI RESA CROMATICA
(CRI 96+) - 3 COLORI
SENSORE ON/OFF CONTACTLESS



**COB LED - cri 96+
3 COLORI**

2700K 4500K 6500K



SENSORE ON/OFF CONTACTLESS



4 LIVELLI DI INCLINAZIONE



FG 235 ~~135,00€~~ **79,00€**

LAMPADA LED AD ELEVATO
INDICE DI RESA CROMATICA
(CRI 96+) - 3 COLORI



**COB LED - cri 96+
3 COLORI**

2700K 4500K 6500K



GANCIO ESTRAIBILE



LENTE SOSTITUIBILE



BASE MAGNETICA
+ SUPER MAGNETE SUL RETRO



BASE DI RICARICA DA TAVOLO
CON PRESA USB + CAVO MICRO USB
DA 1 METRO IN DOTAZIONE





ACCESSORIO TREPPIEDI
NON INCLUSO

FG 236

~~335,00€~~ **199,00€**

FARO LED RICARICABILE PER CONTROLLO COLORE AD ALTO INDICE DI RESA CROMATICA (CRI 96+)

- 5 COLORI - 3 INTENSITA' 500 - 1000 - 2000 LUMEN



2700K 3500K 4500K 5500K 6500K



PANNELLO DI CONTROLLO



CARICABATTERIE A SGANCIO RAPIDO CON CAVO DA 5M



180°



FG 236/SU

~~100,00€~~ **59,00€**

TREPPIEDI PER FARO LED FG 236

PESO NETTO: 1.098 gr

ALTEZZA: 476 MM (CHIUSO) - 1440 MM (APERTO)

NUMERO DI ESTENSIONI DEI PIEDI: 3

MASSIMO CARICO: 2 KG



FG 225/SK1.5

~~300,00€~~ **149,00€**

AVVOLGITORE AUTOMATICO 15M 3GX1.5MM² CON PRESA SCHUKO

LUNGHEZZA CAVO IN INGRESSO 1,20M

15m x 3G 1.5mm² 1000W
230V AC 2000W

FG 225/SK2.5

~~370,00€~~ **169,00€**

AVVOLGITORE AUTOMATICO 15M 3GX2.5MM² CON PRESA SCHUKO

LUNGHEZZA CAVO IN INGRESSO 1,20M

15m x 3G 2.5mm² 1600W
230V AC 3200W



STAFFA A MURO ORIENTABILE A 360°



LIMITATORE DI RIENTRO PER ARRESTARE LA CORSA



SISTEMA DI BLOCCAGGIO A QUALSIASI LUNGHEZZA

NUOVE BORSE PORTA UTENSILI

CAPIENTI, COMODE E SUPER FUNZIONALI. CON LE NUOVE BORSE PORTA UTENSILI FASANO TOOLS PORTI IL TUO LAVORO OVUNQUE E TUTTO QUELLO CHE TI SERVE È SEMPRE CON TE!

6 NUOVI MODELLI per ogni esigenza lavorativa. **Ampi scomparti separati e tasche multiple, laterali e frontali**, per riporre i tuoi utensili, differenziandone l'utilizzo e riprendere poi ciò che ti serve, senza perdere tempo. Non solo attrezzi! I nostri modelli di borse porta utensili sono ideati per trasportare anche oggetti di uso quotidiano come pc, chiavi, smartphone e tutto il necessario per lavorare fuori dagli ambienti di lavoro.



NEW



TROLLEY, TRACOLLE, CESTELLI, BORSONI E ZAINI

Scegli lo **zaino con gli spallacci imbottiti** per avere le mani libere e conservare documenti e pc portatile. Con lo **zaino provvisto di manico telescopico e ruote** invece, puoi viaggiare anche in aereo e fare lunghi tragitti a piedi, senza fatica.

Prediligi un **cestello con copertura**, se preferisci il connubio tra la classica cassetta porta attrezzi ed un borsoni provvisto di tracolla.

Due **borsoni** con ampi scomparti interni e tasche esterne, ti permettono di separare gli oggetti di uso quotidiano dagli utensili da lavoro.

Puoi scegliere tra una struttura completamente rigida o una semi rigida.

Infine, con il **trolley**, trasporti con facilità utensili elettrici o manuali di peso maggiore, dove vuoi, senza sforzi.

Tutte realizzate in tessuto tecnico, le Borse Porta Utensili Fasano Tools sono la tua soluzione versatile ad ogni esigenza giornaliera. E che stile!



FG 1450

~~132,00€~~ **79,00€**

BORSA PORTA UTENSILI IN TESSUTO

TESSUTO TECNICO AD ELEVATA RESISTENZA
BASE SEMI RIGIDA CON RIALZI IN PLASTICA
AMPIO VANO CENTRALE
TASCHE MULTIPLE INTERNE ED ESTERNE
TASCA CHIUSA SUL RETRO
E DOPPIA TASCA CHIUSA FRONTALE CON PASSANTI
TRACCOLLA IMBOTTITA REGOLABILE

NEW



Dimensioni: 460x290x320mm



FG 1456

~~230,00€~~ **139,00€**

TROLLEY PORTAUTENSILI IN TESSUTO

TESSUTO TECNICO AD ELEVATA RESISTENZA
MANICO TELESCOPICO E 2 RUOTE RESISTENTI
STRUTTURA RIGIDA CON AMPIO SCOMPARTO INTERNO
TASCHE INTERNE ED ESTERNE PER UN'OTTIMALE
ORGANIZZAZIONE DELLO SPAZIO
2 TASCHE ESTERNE FRONTALI CHIUSE

NEW

Dimensioni: 470x330x270mm



FG 1452

~~140,00€~~ **85,00€**

CESTELLO PORTA UTENSILI IN TESSUTO CON COVER

STRUTTURA RIGIDA IN TESSUTO TECNICO AD ELEVATA RESISTENZA
BASE IN PLASTICA RIGIDA
AMPIO SCOMPARTO APERTOCOVER
DI CHIUSURA CON VELCRO A SCOMPARSA
MANIGLIONE IN METALLO CON IMPUGNATURA IN GOMMA TASCHE
MULTIPLE E PASSANTI INTERNI ED ESTERNI
TASCA CHIUSA LATERALE E TASCA PORTA SEGNETTO FRONTALE
TRACCOLLA IMBOTTITA REGOLABILE

NEW



Dimensioni: 500x260x360mm



FG 1460

~~150,00€~~ **89,00€**

ZAINO PORTAUTENSILI IN TESSUTO

TESSUTO TECNICO AD ELEVATA RESISTENZA
BASE IN PLASTICA RIGIDA, DOPPIO VANO INTERNO,
PORTA UTENSILI E PORTA PC E DOCUMENTI
TASCHE MULTIPLE LATERALI E FRONTALI,
INTERNE ED ESTERNE
SCHIENALE ERGONOMICO IMBOTTITO
SPALLACCI IMBOTTITI

NEW



Dimensioni: 310x220x460mm



FG 1454

~~180,00€~~ **109,00€**

BORSA PORTA UTENSILI IN TESSUTO

STRUTTURA RIGIDA IN TESSUTO TECNICO AD ELEVATA RESISTENZA
BASE IN PLASTICA RIGIDA PER LA PROTEZIONE DEL CONTENUTO
DUE AMPI SCOMPARTI SEPARATI
TASCHE MULTIPLE E PASSANTI INTERNI ED ESTERNI
TASCHE CHIUSE SUL RETRO E SUL FRONTE
COMODA MANIGLIA E TRACCOLLA IMBOTTITA REGOLABILE

NEW



Dimensioni: 450x250x330mm



FG 1465

~~200,00€~~ **119,00€**

ZAINO PORTAUTENSILI IN TESSUTO CON RUOTE

DIMENSIONI BAGAGLIO A MANO
TESSUTO TECNICO AD ELEVATA RESISTENZA
MANICO TELESCOPICO A SCOMPARSA
RUOTE INTEGRATE CON COVER RICHIUDIBILE
DOPPIO VANO INTERNO,
TASCHE MULTIPLE LATERALI E FRONTALI,
SCHIENALE ERGONOMICO IMBOTTITO
SPALLACCI IMBOTTITI

NEW

Dimensioni: 350x200x520mm



FG 111/AS104

CASSETTA PORTA-UTENSILI FG 111/C CON 5 SCOMPARTI CON ASSORTIMENTO 104 UTENSILI

~~863,50€~~ **299,00€**



FG 111/A

~~60,80€~~ **32,90€**

CASSETTA PORTA-UTENSILI A 3 SCOMPARTI

- PREDISPOSIZIONE PER LUCCHETTO
- DIVISORIO SCOMPARTO SUPERIORE
- STRUTTURA IN LAMIERA



CASSETTA PORTA-UTENSILI A 5 SCOMPARTI

- PREDISPOSIZIONE PER LUCCHETTO
- DIVISORIO SCOMPARTO SUPERIORE
- STRUTTURA IN LAMIERA



CODICE	DIMENSIONE	LISTINO	€/PROMO
FG 111/B	430x200x200mm	72,00	39,90
FG 111/C	530x200x200mm	88,00	49,90

FG 113/A

BAULE PORTA UTENSILI

DOTATO DI MANIGLIONI LATERALI RICHIUDIBILI
PREDISPOSIZIONE PER LUCCHETTO DI CHIUSURA
STRUTTURA IN LAMIERA D'ACCIAIO 0.8MM

DIMENSIONI: 520X290X290mm

NEW



~~175,00€~~ **99,00€**

FG 113/B

BAULE PORTA UTENSILI

DOTATO DI MANIGLIONI LATERALI RICHIUDIBILI
PREDISPOSIZIONE PER LUCCHETTO DI CHIUSURA
STRUTTURA IN LAMIERA D'ACCIAIO 0.8MM

DIMENSIONI: 650X350X350mm

NEW



~~210,00€~~ **119,00€**

FG 113/C

BAULE PORTA UTENSILI

DOTATO DI MANIGLIONI LATERALI RICHIUDIBILI
PREDISPOSIZIONE PER LUCCHETTO DI CHIUSURA
STRUTTURA IN LAMIERA D'ACCIAIO 0.8MM

DIMENSIONI: 850X350X350mm

NEW



~~250,00€~~ **149,00€**

FG 113/D

BAULE PORTA UTENSILI

DOTATO DI MANIGLIONI LATERALI RICHIUDIBILI
PREDISPOSIZIONE PER LUCCHETTO DI CHIUSURA
STRUTTURA IN LAMIERA D'ACCIAIO 0.8MM

DIMENSIONI: 1000X400X450mm

NEW



~~300,00€~~ **184,00€**



BORSE DA LAVORO



FG 1425

~~102,00€~~ **49,00€**

VALIGIA PORTAUTENSILI IN ABS
DIMENSIONE: 456X372X115MM
PESO: 2.1KG



FG 1426

~~120,00€~~ **59,00€**

VALIGIA PORTAUTENSILI IN ABS
DIMENSIONE: 456X372X155MM
PESO: 2.4KG



FG 1427

~~170,00€~~ **89,00€**

VALIGIA PORTAUTENSILI IN ABS
DIMENSIONE: 456X372X262MM
PESO: 3KG



FG 1434

VALIGIA PORTAUTENSILI IN ABS
DOTATA DI BOX INTERNI
DIMENSIONE: 456X372X115MM
PESO: 3.2KG

~~145,00€~~ **69,00€**



FG 1433

CARRELLO PIEGHEVOLE
RICHIUDIBILE

STRUTTURA IN FERRO
BASE IN ALLUMINIO
PESO: 6KG - PORTATA: 100KG
Ø RUOTE: 180MM
CHIUSO: 70X485X835MM
BASE: 480X350MM

~~190,00€~~ **79,00€**



FG 109/L3

CARRELLO PORTA OGGETTI
PIEGHEVOLE

SISTEMA DI BLOCCAGGIO
PESO: 11KG - PORTATA: 300KG
DIMENSIONI:
945X485X810mm

~~280,00€~~ **99,00€**

FG 114/L2

~~65,00€~~ **29,90€**

VALIGIA PORTA UTENSILI IN ABS

- 2 SCOMPARTI SOVRAPPONIBILI E SEPARABILI
- FINESTRE ANTERIORI TRASPARENTI
- MANIGLIA ERGONOMICA ORIENTABILE E REGOLABILE

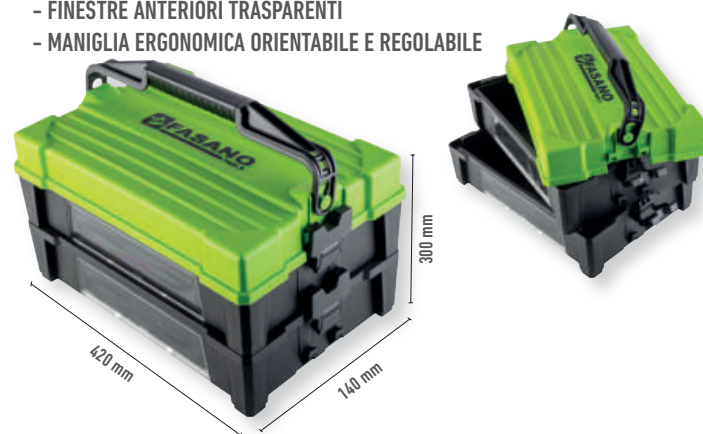

FG 114/L3

~~110,00€~~ **39,90€**

CASSETTA PORTA UTENSILI
A 3 RIPIANI

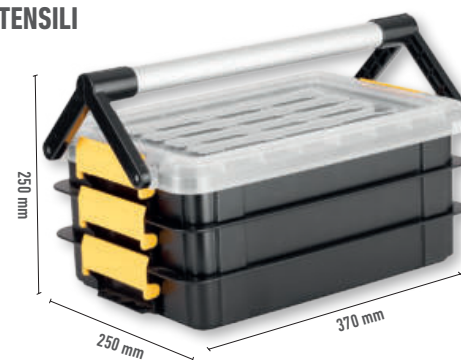



FG 116/A

~~390,00€~~

199,00€

VALIGIA PORTA-UTENSILI IN POLIPROPILENE AD ALTA RESISTENZA

DUE SERRATURE LATERALI CON CHIAVESISTEMA PORTA UTENSILI AD ELASTICO DOTATA DI PIEDINI D'APPOGGIO 3 CERNIERE POSTERIORI IN METALLO FONDO CON DIVISORI AMOVIBILI DOTATA DI VANO TARGHETTA PORTA NOME



DIMENSIONI: 465X215X352mm

FG 117/A

~~450,00€~~

229,00€

VALIGIA PORTA-UTENSILI IN ABS TERMOFORMATO

- 2 SERRATURE LATERALI CON CHIAVE
- SISTEMA PORTA UTENSILI A TASCHE
- DOTATA DI PIEDI DDI APPOGGIO
- FONDO TERMOFORMATO
- SISTEMA TROLLEY INTEGRATO

DIMENSIONI: 453X332X197mm



FG 118/AS56
~~780,90€~~ **429,00€**
**ASSORTIMENTO 56 UTENSILI
PER ELETTROTECNICA**



FG 22E/2.5x75	GIRAVITE ISOLATO A TAGLIO 2.5x75 mm
FG 22E/3x100	GIRAVITE ISOLATO A TAGLIO 3x100 mm
FG 22E/4x100	GIRAVITE ISOLATO A TAGLIO 4x100 mm
FG 22E/5.5x125	GIRAVITE ISOLATO A TAGLIO 5.5x125 mm
FG 22E/6.5x150	GIRAVITE ISOLATO A TAGLIO 6.5x150 mm
FG 22E/PH0x60	GIRAVITE ISOLATO A CROCE PH0x60
FG 22E/PH1x80	GIRAVITE ISOLATO A CROCE PH1x80
FG 22E/PH2x100	GIRAVITE ISOLATO A CROCE PH2x100
FG 129/C4	CACCIASPINA 4mm
FG 129/C5	CACCIASPINA 5mm
FG 126/SL1	SCALPELLO LUNGO PER ELETTRICISTI
FG 126/SL2	SCALPELLO LUNGO PER ELETTRICISTI
FG 127/P1	SCALPELLO PIATTO mm26x240L
FG 602/SP9	SET 9 CHIAVI A DOPPIA FORCHETTA 6x7-21x23mm
FG 139/C	SET 10 CHIAVI MASCHIO A L ESAGONALE LUNGO
FG 96/SS36	SALDATORE A STILO 30/60W
FG 22/FX5	GIRAVITE A BUSSOLA 5mm
FG 22/FX6	GIRAVITE A BUSSOLA 6mm
FG 22/FX7	GIRAVITE A BUSSOLA 7mm
FG 22/FX8	GIRAVITE A BUSSOLA 8mm
FG 22/FX10	GIRAVITE A BUSSOLA 10mm
FG 22/FX13	GIRAVITE A BUSSOLA 13mm
FG 58/IS250	PINZA ISOLATA REGOLABILE A CERNIERA
FG 59/IS180	PINZA UNIVERSALE ISOLATA - 180mm
FG 61/IS200	PINZA ISOLATA BECCHI MEZZOTONDI -200mm
FG 63/IS160	TRONCHESE DIAGONALE ISOLATA -160mm
FG 68IS/160	PINZA SPELLAFILI ISOLATA -160mm
FG 49	FORBICE PER ELETTRICISTA
FG 48/IS	CUTTER ISOLATO PER ELETTRICISTI
FG 68/S1	PINZA X CAPICORDA NON-ISOLATI
FG 22/CF250	GIRAVITE CERCAFASE 110-250V
FG 68/CS2	SPELLAFILI 8-28mm
FG 48/L	CUTTER PROFESSIONALE A LAMA LUNGA
FG 136/L35	MAZZUOLA ANTI-RIMBALZO -35gr
FG 132/300	MARTELLINO TEDESCO CON MANICO IN RESINA -300gr
FG 81/PT2	PUNTE A TRACCIARE
FG 44/MT5	FLESSOMETRO IN NYLON 5Mx25mm
FG 50/MS	MINISEGHETTO CON LAMA
FG 497/OP2	OLIATORE A PRESSIONE CANNUCIA OTTONE 80cc

FG 118/AS75
~~592,30€~~ **349,00€**
**ASSORTIMENTO 75 UTENSILI
PER MANUTENZIONE GENERALE**

FG 602/SP9	SET 9 CHIAVI A DOPPIA FORCHETTA 6x7-21x23mm
FG 22/2.5x75	GIRAVITE A TAGLIO 2.5x75mm
FG 22/3.5x100	GIRAVITE A TAGLIO 3.5x100mm
FG 22/4x150	GIRAVITE A TAGLIO 4x150mm
FG 22/6.5x150	GIRAVITE A TAGLIO 6.5x150mm
FG 22/8x150	GIRAVITE A TAGLIO 8x150mm
FG 22/PH0x60	GIRAVITE A CROCE PH0x60
FG 22/PH1x80	GIRAVITE A CROCE PH1x80
FG 22/PH2x150	GIRAVITE A CROCE PH2x150
FG 58/B240	PINZA REGOLABILE CERNIERA 240mm
FG 59SR/180	PINZA UNIVERSALE -180mm
FG 61SR/160	PINZA BECCHI MEZZOTONDI -160mm
FG 63SR/160	TRONCHESE TAGLIANTI DIAGONALI -160mm
FG 49/HE250	FORBICE MULTIUSO MOD. PESANTE 250mm
FG 69/CJ250	PINZA AUTOBLOCCANTE 250mm
FG 35/B4	CHIAVE A RULLINO mm250
FG 132/500	MARTELLINO TEDESCO CON MANICO IN RESINA -500gr
FG 49	FORBICE PER ELETTRICISTA
FG 44/MT5	FLESSOMETRO IN NYLON 5Mx25mm
FG 80/8AP	LIMA PIATTA TAGLIO MEZZODOLCE 200mm
FG 81/MS	MATITA X FALEGNAME
FG 48/L	CUTTER PROFESSIONALE A LAMA LUNGA
FG 79/SP3	SPAZZOLA FILI RIGIDI IN ACCIAIO
FG 139/C	SET 10 CHIAVI MASCHIO A L ESAGONALE LUNGO
FG 85/S31	SET 31 INSERTI + ADATTATORE PORTA INSERTI
FG 94/300	LIVELLA MAGNETICA 300mm
FG 88/P14	GIRAVITE PORTA INSERTI 1/4"
FG 80/8AQ	LIMA QUADRA TAGLIO MEZZODOLCE 200mm

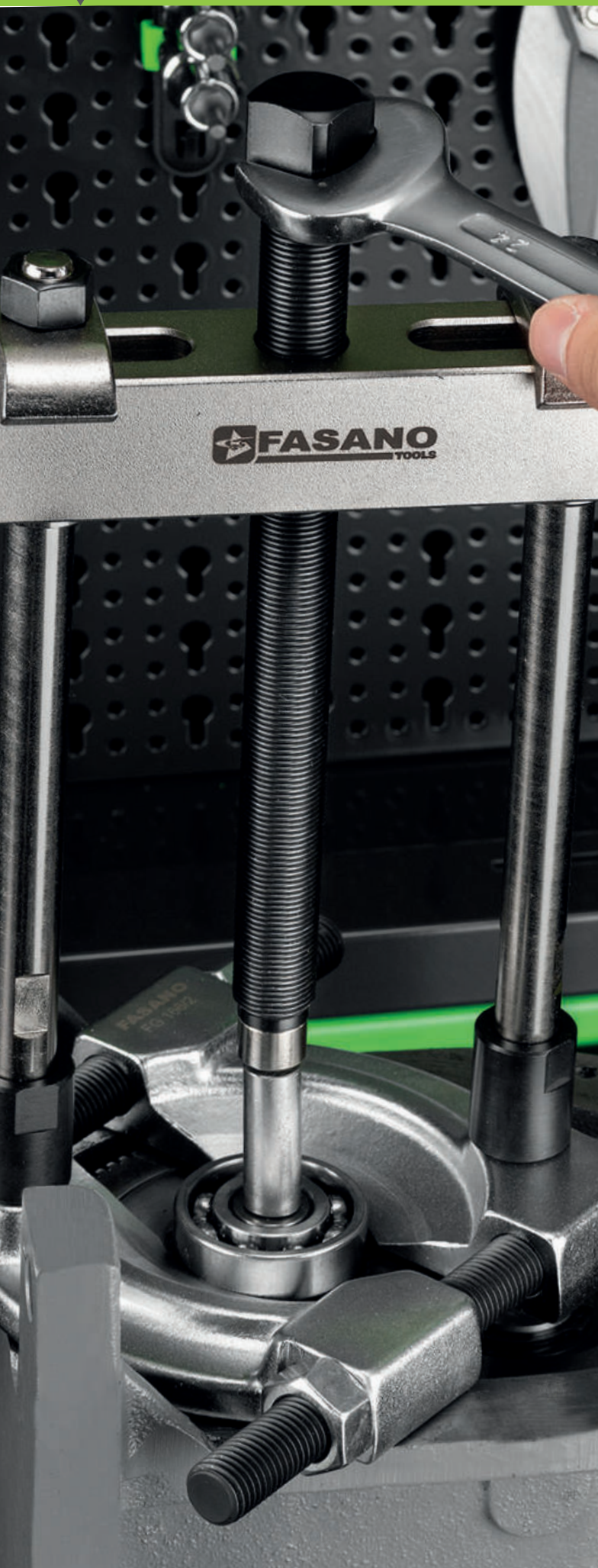

ESTRATTORI



FG 162/S3

~~366,00€~~ 219,00€

SET 3 ESTRATTORI A 2 GRIFFE

27-90MM, 27-135MM, 35-155MM



+



FG 163/S2B

ESTRATTORE A 3 GRIFFE PER PRESA ESTERNA + GRIFFE PER PRESA INTERNA

- APERTURA MAX PER PRESA ESTERNA: 7-140MM

- APERTURA MAX PER PRESA INTERNA: 50-70MM

~~263,00€~~ 155,00€

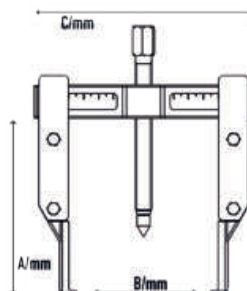

ESTRATTORE UNIVERSALE A 2 GRIFFE SOTTILI

GRIFFE INTERCambiabili SUPER SOTTILI DA 2MM IN ACCIAIO AL CROMO VANADIO
PRESA INTERNA ED ESTERNA VITE IN ACCIAIO AL CROMO VANADIO

CODICE	A/mm	B/mm	C/mm	LISTINO	€/PROMO
FG 168/EF1	110	140	186	319,50	189,00
FG 168/EF2	195	140	186	330,00	199,00

ESTRATTORE UNIVERSALE A 2 GRIFFE

MODELLO A FORBICE

GRIFFE REGOLABILI IN ACCIAIO AL CROMO VANADIO

PRESA ESTERNA

VITE IN ACCIAIO AL CROMO VANADIO

CODICE	A/mm	LISTINO	€/PROMO
FG 162/FR1	90	149,50	89,90
FG 162/FR2	125	196,00	119,00
FG 162/FR3	125	237,00	139,00



ESTRATTORE AUTOCENTRANTE A 3 GRIFFE

- POSSIBILITÀ DI 4 POSIZIONI DIFFERENTI
- PRESA ESTERNA
- MECCANISMO AUTOCENTRANTE
- GRIFFE CON APERTURA PER CONSENTIRE UNA MIGLIOR PRESA SU BULLONI SPECIALI

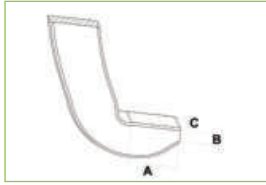

CODICE	CAPACITÀ	APERTURA	AXBXC/mm	HxL/mm	LISTINO	€/PROMO
FG 160/1	2 TON	20 - 115MM	8X6X15	80X120	108,50	65,00
FG 160/2	5 TON	30 - 240MM	11X10X25	160X250	235,00	139,00
FG 160/3	10 TON	40 - 380MM	14X10X29	230X280	420,00	249,00

ESTRATTORE MANUALE DI GRANDE POTENZA A 3 GRIFFE

- PRESA ESTERNA
- LE LEVE DI SUPPORTO AD OGNI GRIFFA MOLTIPLICANO LA POTENZA GARANTENDO LIVELLI DI FORZA ELEVATI

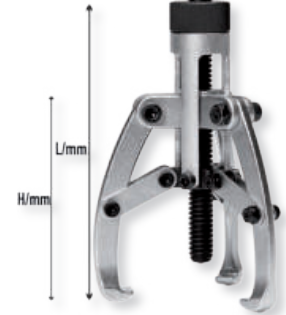
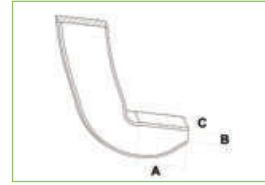

CODICE	CAPACITÀ	APERTURA	AXBXC/mm	HxL/mm	LISTINO	€/PROMO
FG 161/1	2 TON	28 - 112MM	8X6X15	80X120	124,00	75,00
FG 161/2	5 TON	40 - 243MM	11X10X25	160X250	250,00	149,00
FG 161/3	10 TON	46 - 370MM	14X10X29	230X280	474,00	289,00



SET ESTRATTORI PER DADI DESTORSI DANNEGGIATI CON ATTACCO 1/2"

FORNITO SU SUPPORTO IN ABS APPENDIBILE CON GANCI A CLIP E MECCANISMO FINECORSA ANTICADUTA

NEW

CODICE	CONTENUTO MM	LISTINO	€/PROMO
FG 168A/S5	22, 24, 27, 30, 32	110,00	65,00
FG 168A/S13	8, 9, 10, 11, 12, 13, 14, 15, 16, 17, 18, 19, 21	210,00	129,00

FG 168EP/S5

SET 5 ESTRATTORI CONICI PER VITI E PRIGIONIERI SPEZZATI

- INSERIMENTO A PERCUSSIONE



~~33,00€~~ **19,90€**

FG 182/S5B

~~475,00€~~ **279,00€**

SET ESPANSORI A SETTORE PER INTERNI CON ACCESSORI

CONTENUTO: FG 182/EG1 - FG 182/ES1
FG 182/ES2 - FG 182/ES3 - FG 182/ES4 - FG 182/ES5

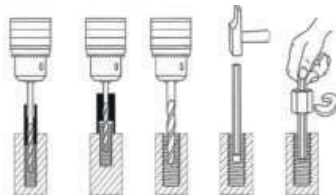

- DOTATO DI GUIDE PER INTERNO ED ESTERNO E PUNTE PER FORARE
- PER VITI/BULLONI CON DIAMETRO 6-16MM

FG 168/S25

~~144,00€~~ **79,00€**

SET ESTRATTORI PER VITI E PRIGIONIERI SPEZZATI



FG 182/S14

~~238,00€~~ **145,00€**

SET ESTRATTORI PER CUSCINETTI CON FALSE SFERE

- ØMM: 5, 6, 8, 9, 11, 12,5



UTENSILI PNEUMATICI



CE



COPPIA DI SPUNTO



MARTELLINO SINGOLO



FGA 307

~~250,00€~~ 149,00€

AVVITATORE AD IMPULSI-1/2"



CE



COPPIA DI SPUNTO



MARTELLINO DOPPIO



FGA 309

~~300,00€~~ 179,00€

AVVITATORE AD IMPULSI-1/2"



CE



COPPIA DI SPUNTO



MARTELLLO DOPPIO



FGA 312

~~380,00€~~ **199,00€**

AVVITATORE AD IMPULSI-1/2"



CE



MARTELLLO DOPPIO



FGA 302

~~240,00€~~ **125,00€**

AVVITATORE AD IMPULSI-1/2"



CE



Coppia di spunto



Martello singolo



FGA 307/AN

~~340,00€~~ **179,00€**

AVVITATORE ANGOLARE AD IMPULSI-1/2"



FGA 309/S4

SET AVVITATORE 1/2" FGA 309 + 03 BUSSOLE RINFORZATE X CERCHI IN LEGA LEGGERA

~~385,00€~~ **235,00€**



FGA 309/S10

SET AVVITATORE 1/2" FGA 309 + 9 BUSSOLE RINFORZATE CORTE 1/2"

~~395,00€~~ **239,00€**



UTENSILI PNEUMATICI

FGA 316/L

~~830,00€~~ **489,00€**

AVVITATORE AD IMPULSI - 3/4"
AD ALBERO LUNGO 6"

FGA 316

~~760,00€~~ **439,00€**

AVVITATORE AD IMPULSI-3/4"



CE

MARTELLINO DOPPIO



FGA 319/L

~~1.250,00€~~ **659,00€**

AVVITATORE AD IMPULSI 1"
AD ALBERO LUNGO 6"

FGA 319

~~1.150,00€~~ **599,00€**

AVVITATORE AD IMPULSI -1"



CE

PIN-LESS



FGA 321/B

~~1.100,00€~~ **579,00€**

AVVITATORE AD IMPULSI 1"
AD ALBERO LUNGO 6"

FGA 321

~~1.050,00€~~ **559,00€**

AVVITATORE AD IMPULSI -1"



CE

MARTELLINO DOPPIO





PIN-LESS

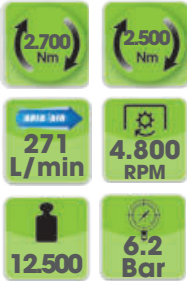

FGA 321/C

~~1.220,00€~~ **629,00€**

AVVITATORE AD IMPULSI 1"
AD ALBERO LUNGO 6"



IDEALE PER UTILIZZI INTENSIVI



FGA 290

CRICCHETTO REVERSIBILE 1/4"

SISTEMA DI REVERSIBILITÀ INTEGRATA SULLA TESTA
SISTEMA DI AZIONAMENTO A PINZA
ATTACCO ARIA 1/4" GAS
Ø INTERNO TUBO ARIA 10MM (3/8")



~~192,00€~~ **115,00€**



COPPIA
TORCENTE



FGA 292/B

~~215,00€~~ **129,00€**

CRICCHETTO REVERSIBILE 1/2"



FGA 390

PISTOLA DI
GONFIAGGIO



~~150,00€~~ **85,00€**

- OMOLOGATA CEE

- CORPO IN ALLUMINIO NICHELATO
- RIVESTIMENTO IN GOMMA ANTIOGLIO
- MANOMETRO Ø80 (0-10BAR)
- PROTEZIONE SOVRAPRESSIONI
- LEVA A DUE POSIZIONI SCARICO/GONFIAGGIO
- LUNGHEZZA TUBO: 500MM



FGA 322

LEVIGATRICE
PER PNEUMATICI

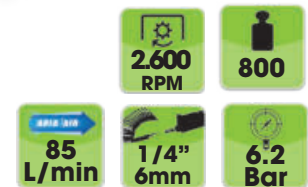
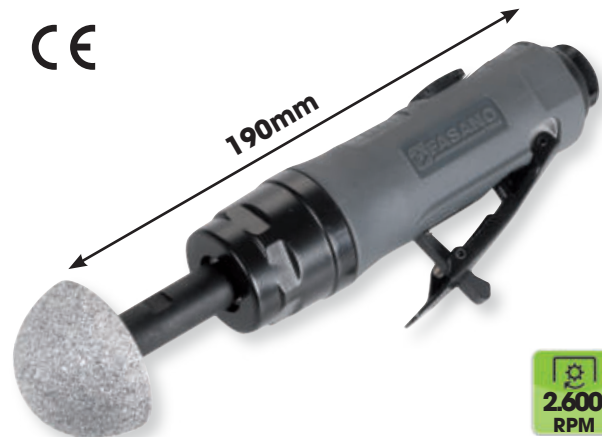

FGA 322/R2: MOLA DI
RICAMBIO 30,00€

~~140,00€~~ **85,00€**



UTENSILI PNEUMATICI

FGA 332



TRAPANO REVERSIBILE CON
MANDRINO AUTOSERRANTE 1-10MM



0.45 Hp	1.800 RPM	900
113 L/min	1/4" 6mm	6:2 Bar

~~145,00€~~ **89,00€**

FGA 333



TRAPANO REVERSIBILE CON
MANDRINO AUTOSERRANTE 1-13MM



0.45 Hp	700 RPM	1.300
113 L/min	1/4" 6mm	6:2 Bar

~~185,00€~~ **109,00€**

FGA 333/AC

~~210,00€~~ **129,00€**

TRAPANO REVERSIBILE CON
MANDRINO IN ACCIAIO 1-13MM



0.45 Hp	700 RPM	1.200
113 L/min	1/4" 6mm	6:2 Bar



FGA 332/AN

~~180,00€~~ **109,00€**

TRAPANO ANGOLARE
MANDRINO AUTOSERRANTE
1-10MM



0.45 Hp	1.800 RPM	900
60 L/min	1/4" 6mm	6:2 Bar



FGA 340

~~295,00€~~ **169,00€**

- ø orbita: 5.0mm
- platorello 15 fori

152mm	11.000 RPM	900
45.2 L/min	1/2" 13mm	6:2 Bar

150mm	11.000 RPM	800
46 L/min	1/4" 6mm	6:2 Bar

FGA 340/B

~~295,00€~~ **169,00€**

- ø orbita: 2.5mm
- platorello 15 fori



FGA 342/B

LEVIGATRICE
ROTO-ORBITALE

- ø orbita: 2.5mm
- platorello 3 fori

75mm	11.000 RPM	500
46 L/min	1/4" 6mm	6:2 Bar

~~285,00€~~ **169,00€**



FGA 337

CE

**LEVIGATRICE PNEUMATICA
PER RIMOZIONE RESIDUI GOMMOSI**

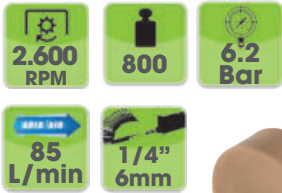

~~125,00€~~ **75,00€**

FGA 330

CE

SEGHETTO ALTERNATIVO



~~295,00€~~ **169,00€**

FGA 339

~~355,00€~~ **199,00€**

LEVIGATRICE ANGOLARE - Ø DISCO: 115MM

Capacità disco: 115mm
Sistema di regolazione velocità a pinza
Attacco aria 1/4" gas
Ø interno tubo aria 10mm (3/8")



FGA 346/B

~~220,00€~~ **129,00€**

MICROSMERIGLIATRICE ASSIALE

- Capacità pinza: 3mm



CE

FGA 335

RIVETTATRICE PNEUMATICA

- 4 testine intercambiabili



~~210,00€~~ **115,00€**

FGA 336

RIVETTATRICE PNEUMATICA

- 4 testine intercambiabili



~~600,00€~~ **359,00€**



UTENSILI PNEUMATICI

FGA 338

SMERIGLIATRICE DIRITTA A PINZA

~~125,00€~~ **75,00€**

0.50 Hp	22.000 RPM	600
99 L/min	1/4" 6mm	6.2 Bar



CE

LAME ROTORE IN KEVLAR

FGA 334

SMERIGLIATRICE DIRITTA A PINZA

~~145,00€~~ **89,00€**

0.35 Hp	25.000 RPM	400
74 L/min	1/4" 6mm	6.2 Bar



CE

FGA 338/B

SMERIGLIATRICE DIRITTA A PINZA A BASSA VELOCITA'

~~160,00€~~ **95,00€**

0.45 Hp	7.600 RPM	600
74 L/min	1/4" 6mm	6.2 Bar



CE

FGA 334/AN115

SMERIGLIATRICE ANGOLARE A PINZA - INCLINAZIONE 115°

~~185,00€~~ **109,00€**

0.35 Hp	22.000 RPM	600
74 L/min	1/4" 6mm	6.2 Bar



CE

FGA 338/AN

SMERIGLIATRICE ANGOLARE A PINZA

~~170,00€~~ **99,00€**

0.45 Hp	18.000 RPM	700
60 L/min	1/4" 6mm	6.2 Bar



CE

FGA 334/AN

SMERIGLIATRICE ANGOLARE A PINZA

~~185,00€~~ **109,00€**

0.35 Hp	22.000 RPM	500
60 L/min	1/4" 6mm	6.2 Bar



CE

FGA 338/L

SMERIGLIATRICE DIRITTA A PINZA AD ALBERO LUNGO

~~165,00€~~ **99,00€**

0.45 Hp	22.000 RPM	800
60 L/min	1/4" 6mm	6.2 Bar



CE

FGA 334/L

SMERIGLIATRICE DIRITTA A PINZA AD ALBERO LUNGO

~~185,00€~~ **109,00€**

0.35 Hp	25.000 RPM	700
74 L/min	1/4" 6mm	6.2 Bar



CE

FGA 343/N10



LEVIGATRICE A NASTRO
- 10x330mm

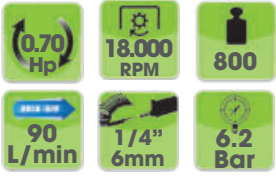

~~220,00€~~ **135,00€**



FGA 342

LEVIGATRICE ORBITALE
- ø orbita: 2mm



~~220,00€~~ **129,00€**



FGA 343/N20



LEVIGATRICE A NASTRO
- 20X520MM

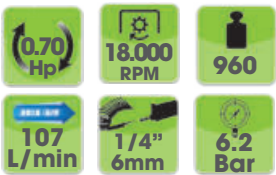

~~285,00€~~ **175,00€**



FGA 341

~~650,00€~~ **399,00€**

LEVIGATRICE MULTI-FUNZIONE

Sistema di aspirazione integrato nel corpo macchina
Supporto laterale girevole a 180°
Attacco aria 1/4" gas
Ø interno tubo aria 10mm (3/8")



TUBO IN POLIURETANO RETINATO
STAFFA A MURO ORIENTABILE A 360°

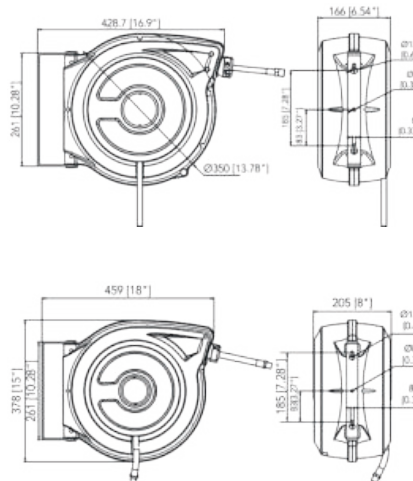

FGA 383/AR15

AVVOLGITUBO AUTOMATICO
PER ARIA COMPRESSA -15MT.
- ø tubo interno: 8mm

~~270,00€~~ **139,00€**

FGA 385/AR15

AVVOLGITUBO AUTOMATICO
PER ARIA COMPRESSA -15MT.
- ø tubo interno: 10mm

~~360,00€~~ **179,00€**

Guida di scorrimento
automatico



Sistema di bloccaggio
a qualsiasi lunghezza



Riavvolgimento a
velocità controllata





CARRELLI E BANCHI DA LAVORO



**5 VARIANTI COLORE
PER ARREDARE I TUOI SPAZI**

RAL
7021

RAL
9016

RAL
6018

RAL
5002

RAL
3001



MADE IN ITALY



**SCEGLI TRA I MODELLI A DISPOSIZIONE
QUELLO PIU' ADATTO ALLE TUE NECESSITA'**



SIMPLE TOOL TROLLEY



EXTENDED TOOL TROLLEY



KG 800
PORTATA STATICA

MADE IN ITALY

FG 100 BI COLOR

NEW

CARRELLO PORTA UTENSILI BICOLOR A 7 CASSETTI MOD. FG 100

CARATTERISTICHE TECNICHE:

- Guide telescopiche con sistema di aggancio automatico
- 4 ruote in gomma vulcanizzata Ø125mm
- ripiano superiore in ABS con maniglione integrato
- chiusura laterale centralizzata
- porta flaconi laterali di serie

CODICE	RAL	€/LISTINO	€/PROMO
FG 100VD/7T	6018+7021	1.350,00	699,00
FG 100VW/7T	6018+9016	1.350,00	699,00
FG 100BW/7T	5002+9016	1.350,00	699,00
FG 100BD/7T	5002+7021	1.350,00	699,00
FG 100RD/7T	3001+7021	1.350,00	699,00
FG 100RY/7T	3001+1018	1.350,00	699,00
FG 100CW/7T	5012+9016	1.350,00	699,00
FG 100MA/7T	3004+9016	1.350,00	699,00
FG 100RW/7T	3001+9016	1.350,00	699,00
FG 100RB/7T	3001+5002	1.350,00	699,00
FG 100DP/7T	7021+3015	1.350,00	699,00
FG 100DW/7T	7021+9016	1.350,00	699,00
FG 100BY/7T	5002+1018	1.350,00	699,00
FG 100GW/7T	3004+9016	1.350,00	699,00



KG 800
PORTATA STATICA

MADE IN ITALY

FG 100

CARRELLO PORTA UTENSILI MOD. FG 100

CARATTERISTICHE TECNICHE:

- Guide telescopiche con sistema di aggancio automatico
- 4 ruote in gomma vulcanizzata Ø125mm
- ripiano superiore in ABS con maniglione integrato
- chiusura laterale centralizzata
- porta flaconi laterali di serie



CODICE	CASSETTI	€/LISTINO	€/PROMO
FG 100V/5T	5 CASSETTI	1.000,00	519,00
FG 100V/6T	6 CASSETTI	1.050,00	539,00
FG 100V/7T	7 CASSETTI	1.100,00	559,00

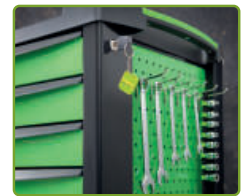

SISTEMA DI CHIUSURA LATERALE



RIPIANO SUPERIORE IN ABS



CASSETTO CON APERTURA COMPLETA

CARRELLI E BANCHI DA LAVORO



FG 102

CARRELLO PORTA UTENSILI MOD. FG 102

CARATTERISTICHE TECNICHE:

- Guide telescopiche con sistema di aggancio automatico
- 4 ruote in gomma vulcanizzata Ø125mm
- maniglione laterale in acciaio
- chiusura centralizzata
- cassetti dotati di tappetino interno in gomma



4 RUOTE Ø125
(2 GIREVOLI-2 FISSE)



TOP IN GOMMA



MANIGLIONE IN ACCIAIO



KG 800 PORTATA
STATICA

MADE IN ITALY

CODICE	Cassetti	€/Listino	€/PROMO
FG 102V/5G	5 CASSETTI	960,00	469,00
FG 102V/6G	6 CASSETTI	1.030,00	499,00
FG 102V/7G	7 CASSETTI	1.100,00	529,00
FG 102V/8G	8 CASSETTI	1.150,00	559,00



FG 104

CARRELLO PORTA UTENSILI MOD. FG 104

CARATTERISTICHE TECNICHE:

- Guide telescopiche con sistema di aggancio automatico
- 4 ruote in gomma vulcanizzata Ø125mm
- maniglione laterale in acciaio
- chiusura centralizzata
- cassetti dotati di tappetino interno in gomma



MANIGLIONE IN ACCIAIO INOX



CHIUSURA CENTRALIZZATA



KG 1000 PORTATA
STATICA

MADE IN ITALY

CODICE	CASSETTI	€/LISTINO	€/PROMO
FG 104V/6G	6 CASSETTI	1.250,00	579,00
FG 104V/7G	7 CASSETTI	1.350,00	599,00



FG 105

CARRELLO PORTA UTENSILI MOD. FG 105

CARATTERISTICHE TECNICHE:

- Guide telescopiche con sistema di aggancio automatico
- 4 ruote in gomma vulcanizzata Ø125mm
- maniglione laterale in acciaio
- chiusura centralizzata
- cassetti dotati di tappetino interno in gomma



RIPIANI INTERNI REGOLABILI



ANTINA APRIBILE A 90°, DOTATA DI SERRATURA

FG 105 XL

MADE IN ITALY



CODICE				CASSETTI	€/LISTINO	€/PROMO
FG 105V/5G	FG 105B/5G	FG 105R/5G	FG 105D/5G	5 CASSETTI	1.300,00	689,00
FG 105V/6G	FG 105B/6G	FG 105R/6G	FG 105D/6G	6 CASSETTI	1.400,00	739,00
FG 105V/7G	FG 105B/7G	FG 105R/7G	FG 105D/7G	7 CASSETTI	1.450,00	769,00



FG 109

CARRELLO PORTA UTENSILI MOD. FG 109 CON APPENDICE LATERALE



RIPIANI IN GOMMA



RIPIANI INTERNI AMOVIBILI E REGOLABILI

FG 109 XXL

MADE IN ITALY



CODICE				CASSETTI	€/LISTINO	€/PROMO
FG 109V/6G	FG 109B/6G	FG 109R/6G	FG 109D/6G	6 CASSETTI	1.600,00	849,00
FG 109V/7G	FG 109B/7G	FG 109R/7G	FG 109D/7G	7 CASSETTI	1.650,00	879,00

CARRELLI E BANCHI DA LAVORO



KG 500 PORTATA STATICA

FG 101

CARRELLO PORTA UTENSILI MOD. FG 101

CARATTERISTICHE TECNICHE:

- Guide telescopiche con sistema di aggancio automatico
- 4 ruote in gomma vulcanizzata Ø125mm (2 fisse e 2 girevoli - 1 con freno)
- maniglione laterale in acciaio
- chiusura centralizzata
- cassetti dotati di tappetino interno in gomma



SISTEMA DI APERTURA A BAIONETTA



MANIGLIONE IN ACCIAIO



TOP IN GOMMA

FG101

CODICE	CASSETTI	€/LISTINO	€/PROMO
FG 101V/5G	5 CASSETTI	680,00	359,00
FG 101V/6G	6 CASSETTI	710,00	379,00
FG 101V/7G	7 CASSETTI	750,00	399,00



2 RIPIANI (SUPERIORE E INFERIORE) PORTA OGGETTI 680X440MM



POSSIBILITA' DI INSERIMENTO MODULI UTENSILERIA

FG 101V/3G

~~500,00€~~ **249,00€**

CARRELLO PORTA UTENSILI A 3 CASSETTI MOD. FG 101



DOTATO DI 16 VASCHETTA AMOVIBILI PORTA MINUTERIE



STRUTTURA LATERALE IN ALLUMINIO E RIPIANI E ACCESSORI IN ABS

FG 108/B

~~180,00€~~ **89,00€**

CARRELLO MULTI-SERVIZIO UNIVERSALE PER MINUTERIE E ATTREZZI DA LAVORO



CODICE	CASSETTI	€/LISTINO	€/PROMO
FG 160V/14L	14 CASSETTI	-3.550,00-	1.889,00
FG 160B/14L			
FG 160R/14L			
FG 160D/14L			

FG 160

CARRELLO PORTA UTENSILI MOD. FG 160

CARATTERISTICHE TECNICHE:

- Guide telescopiche con sistema di aggancio automatico
- 4 ruote in gomma vulcanizzata Ø160mm
- maniglione laterale in acciaio
- chiusura centralizzata
- cassetti dotati di tappetino interno in gomma



- Antina apribile a 90°, dotata di serratura con chiave
- 2 ripiani interni amovibili

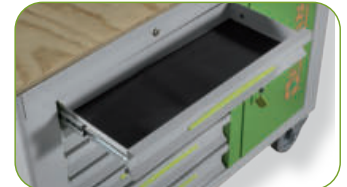

- 7 cassetti porta minuteria
- Profondità: 580x235mm



- Larga griglia laterale porta utensili
- Dimensioni: 665x595mm



**PORTATA
STATICA**

JUMBO

MADE IN ITALY

FG 94/MS

**SUPPORTO MAGNETICO
PORTA UTENSILI**



PVC ANTI-GRAFFIO



~~34,00€~~ **18,90€**

FG 94/MI

**SUPPORTO MAGNETICO
PORTA UTENSILI**

DIMENSIONI: 120x94x400mm



**PORTATA
MASSIMA**



~~52,00€~~ **24,90€**



FG 94/R

PORTA MINUTERIE MAGNETICO

Dimensione: 165x245mm

~~20,00€~~ **11,90€**



FG 94/T

PORTA MINUTERIE MAGNETICO

Ø 150mm

~~17,00€~~ **9,90€**



CARRELLI E BANCHI DA LAVORO



FG 101V/AS106

CARRELLO PORTA UTENSILI A 3 CASSETTI MOD. FG 101 CON ASSORTIMENTO 106 UTENSILI IN MODULI RIGIDI

~~1.295,00€~~ **499,00€**



2 RIPIANI (SUPERIORE E INFERIORE) PORTA OGGETTI 680X440MM



POSSIBILITA' DI INSERIMENTO MODULI UTENSILERIA

1°CASSETTO

- **FG 102/03G:** Modulo 14 chiavi combinate 6 - 19mm
- **FG 102/17:** Modulo 11 chiavi a bussola da 1/4" 4-14mm + accessori
- **FG 102/21E:** Modulo chiavi a bussola esagonali 1/2" 8-32mm + accessori



2°CASSETTO

- **FG 102/48D:** Modulo inserti + portainseri 1/4"
- **FG 102/VA1:** Modulo porta minuterie
- **FG 102/65B:** Modulo pinza autobloccante e pinza regolabile a cerniera aperta



3°CASSETTO

- **FG 102/45D:** Modulo 6 giraviti taglio e croce
- **FG 102/45I:** Modulo 6 giraviti con impronta Torx
- **FG 102/39D:** Modulo 3 pinze





FG 101V/AS136

**CARRELLO PORTA UTENSILI FG 101
A 6 CASSETTI CON ASSORTIMENTO
136 UTENSILI IN MODULI RIGIDI**

~~1.830,00€~~ **699,00€**

KG 500 **PORTATA STATICA**



**SISTEMA DI APERTURA
A BAIONETTA**



**MANIGLIONE IN
ACCIAIO**



TOP IN GOMMA

1°CASSETTO

- **FG 102/03G:** Modulo 14 chiavi combinate 6 - 19mm
- **FG 102/17:** Modulo 11 chiavi a bussola da 1/4" 4-14mm + accessori
- **FG 102/21E:** Modulo chiavi a bussola esagonali 1/2" 8-32mm + accessori

2°CASSETTO

- **FG 102/21TX:** Modulo 44 utensili con impronta Torx
- **FG 102/21H:** Modulo rigido inserti a bussola 1/2" esagonali e XZN
- **FG 102/65B:** Modulo pinza autobloccante e pinza regolabile a cerniera aperta



3°CASSETTO

- **FG 102/45D:** Modulo 6 giraviti taglio e croce
- **FG 102/45I:** Modulo 6 giraviti con impronta Torx
- **FG 102/39D:** Modulo 3 pinze



CARRELLI E BANCHI DA LAVORO



FG 101V/AS187

**CARRELLO PORTA UTENSILI FG 101
A 7 CASSETTI CON ASSORTIMENTO
187 UTENSILI IN MODULI RIGIDI**

~~2.024,00€~~ **799,00€**

KG 500 PORTATA
STATICA



**SISTEMA DI APERTURA
A BAIONETTA**



**MANIGLIONE IN
ACCIAIO**



TOP IN GOMMA

1°CASSETTO

- FG 102/03G: Modulo 14 chiavi combinate 6 - 19mm
- FG 102/17E: Modulo 65 utensili da 1/4"
- FG 102/21E: Modulo chiavi a bussola esagonali 1/2" 8-32mm + accessori



2°CASSETTO

- FG 102/39D: Modulo 3 pinze
- FG 102/45I: Modulo 6 giraviti con impronta Torx
- FG 102/45D: Modulo 6 giraviti taglio e croce



3°CASSETTO

- FG 102/48G: Modulo 52 inserti - attacco 10mm
- FG 102/60D: Modulo utensili per manutenzione
- FG 102/23C: Modulo 14 utensili rinforzati da 1/2"



4°CASSETTO

- FG 618/A8, A10, A13, A17, A19: Chiavi a T esagonali snodate





FG 102V/AS158

**CARRELLO PORTA UTENSILI FG 102
A 6 CASSETTI CON ASSORTIMENTO
158 UTENSILI IN MODULI RIGIDI**

~~2.571,00€~~ **999,00€**

**KG
800** PORTATA
STATICA



CODICE			
FG 102V/AS158	FG 102B/AS158	FG 102R/AS158	FG 102D/AS158



**4 RUOTE Ø125
(2 GIREVOLI-2 FISSE)**



TOP IN GOMMA



**MANIGLIONE IN
ACCIAIO**

1°CASSETTO

- FG 102/03G: Modulo 14 chiavi combinate 6 - 19mm
- FG 102/21B: Modulo chiavi a bussola esagonali 1/2" 8-32mm + accessori
- FG 102/17: Modulo 11 chiavi a bussola da 1/4" 4-14mm + accessori



2°CASSETTO

- FG 102/21TX: Modulo 44 utensili TORX
- FG 102/21H: Modulo rigido inserti a bussola 1/2" esagonali e XZN
- FG 102/39XT: Modulo 3 pinze - serie Industrial



3°CASSETTO

- FG 102/45F: Modulo 6 giraviti a croce phillips
- FG 102/45G: Modulo 7 giraviti ad intaglio
- FG 102/45I: Modulo 6 giraviti TORX



4°CASSETTO

- FG 102/10C: Modulo 8 chiavi a T snodate esagonali 7-19mm

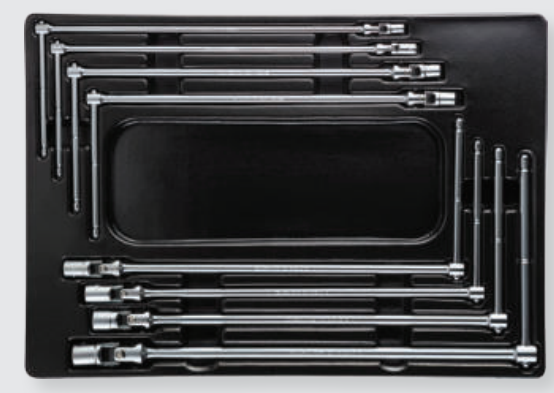

CARRELLI E BANCHI DA LAVORO



FG 102V/AS168

NEW

CARRELLO PORTA UTENSILI FG 102
A 7 CASSETTI CON ASSORTIMENTO
168 UTENSILI IN MODULI RIGIDI

~~2.556,00€~~

1.099,00€

KG
800
PORTATA
STATICA



CODICE

FG 102V/AS168

FG 102B/AS168

FG 102R/AS168

FG 102D/AS168



4 RUOTE Ø125
(2 GIREVOLI-2 FISSE)



TOP IN GOMMA



MANIGLIONE IN
ACCIAIO

1°CASSETTO

- FG 102/03G: Modulo 14 chiavi combinate 6 - 19mm
- FG 102/21B: Modulo chiavi a bussola esagonali 1/2" 8-32mm + accessori
- FG 102/17E: Modulo 65 utensili da 1/4"

2°CASSETTO

- FG 102/42C: Modulo 4 pinze per anelli elastici
- FG 102/39XT: Modulo 3 pinze - serie Industrial
- FG 102/21H: Modulo rigido inserti a bussola 1/2" esagonali e XZN



3°CASSETTO

- FG 102/45F: Modulo 6 giraviti a croce phillips
- FG 102/45G: Modulo 7 giraviti ad intaglio
- FG 102/45I: Modulo 6 giraviti TORX

4°CASSETTO

- FG 102/56C: Modulo utensili da percussione
- FG 102/60D: Modulo utensili per manutenzione
- FG 102/65B: Modulo pinza autobloccante e inza regolabile a cerniera aperta





FG 100V/AS212

NEW

**CARRELLO PORTA UTENSILI FG 100
A 7 CASSETTI CON ASSORTIMENTO
212 UTENSILI IN MODULI RIGIDI**

~~2.721,00€~~ **1.099,00€**

**KG
800** **PORTATA
STATICA**



CODICE

FG 100V/AS212	FG 100B/AS212	FG 100R/AS212	FG 100D/AS212	FG 100W/AS212
---------------	---------------	---------------	---------------	---------------



**SISTEMA DI CHIUSURA
LATERALE**



**RIPIANO SUPERIORE
IN ABS**



**CASSETTO CON
APERTURA COMPLETA**

1°CASSETTO

- **FG 102/03G:** Modulo 14 chiavi combinate 6 - 19mm
- **FG 102/03L:** Modulo 6 chiavi combinate
- **FG 102/21B:** Modulo chiavi a bussola esagonali 1/2" 8-32mm + accessori

2°CASSETTO

- **FG 102/17E:** Modulo 65 utensili da 1/4"
- **FG 102/19:** Modulo utensili con attacco quadro 3/8"
- **FG 102/45I:** Modulo 6 giraviti con impronta Torx



3°CASSETTO

- **FG 102/39XT:** Modulo 3 pinze - serie Industrial
- **FG 102/39D:** Modulo 3 pinze
- **FG 102/45E:** Modulo 8 giraviti ad intaglio e a croce phillips

4°CASSETTO

- **FG 102/56C:** Modulo utensili da percussione
- **FG 102/65B:** Modulo pinza autobloccante e inza regolabile a cerniera aperta
- **FG 102/48G:** Modulo inserti corti e lunghi con attacco 10mm



CARRELLI E BANCHI DA LAVORO



FG 100V/AS183

NEW

CARRELLO PORTA UTENSILI FG 100
A 7 CASSETTI CON ASSORTIMENTO
183 UTENSILI IN MODULI RIGIDI

~~2.647,00€~~ 1.149,00€

KG
800 PORTATA
STATICA



CODICE

FG 100V/AS183 FG 100B/AS183 FG 100R/AS183 FG 100D/AS183 FG 100W/AS183



SISTEMA DI CHIUSURA
LATERALE



RIPIANO SUPERIORE
IN ABS



CASSETTO CON
APERTURA COMPLETA

1°CASSETTO

- FG 102/03G: Modulo 14 chiavi combinate 6 - 19mm
- FG 102/03L: Modulo rigido 6 chiavi combinate
- FG 102/21B: Modulo chiavi a bussola esagonali 1/2" 8-32mm + accessori



2°CASSETTO

- FG 102/17: Modulo 11 chiavi a bussola da 1/4" 4-14mm + accessori
- FG 102/48G: Modulo inserti corti e lunghi con attacco 10mm
- FG 102/21TX: Modulo 44 utensili Torx



3°CASSETTO

- FG 102/39XT: Modulo 3 pinze - serie Industrial
- FG 102/45D: Modulo 6 giraviti a taglio e a croce
- FG 102/45I: Modulo 6 giraviti con impronta Torx



4°CASSETTO

- FG 102/10C: Modulo 8 chiavi a T snodate esagonali 7-19mm





FG 100V/AS371

NEW

**CARRELLO PORTA UTENSILI FG 100
A 7 CASSETTI CON ASSORTIMENTO
371 UTENSILI IN MODULI RIGIDI**

~~3.718,80€~~ **1.399,00€**

**KG
800** **PORTATA
STATICA**



CODICE

FG 100V/AS371 FG 100B/AS371 FG 100R/AS371 FG 100D/AS371 FG 100W/AS371



- **FG 102/03G:** Modulo 14 chiavi combinate 6 - 19mm
- **FG 102/03L:** Modulo rigido 6 chiavi combinate
- **FG 102/03E:** Modulo 8 chiavi doppia forchetta
- **FG 102/17E:** Modulo 65 utensili da 1/4"
- **FG 102/19:** Modulo utensili con attacco quadro 3/8"
- **FG 102/21B:** Modulo utensili con attacco quadro 1/2"
- **FG 102/21TX:** Modulo utensili torx con attacco 1/4" e 1/2"
- **FG 102/21H:** Modulo inserti a bussola esagonali e xzn con attacco 1/2"
- **FG 102/21R:** Modulo inserti a bussola ribe con attacco 1/2"

- **FG 102/56C:** Modulo utensili da percussione
- **FG 102/39XT:** Modulo 3 pinze - serie Industrial
- **FG 102/42C:** Modulo 4 pinze per anelli elastici
- **FG 102/45G:** Modulo 7 giraviti con testa ad intaglio
- **FG 102/45F:** Modulo 6 giraviti con testa a croce phillips
- **FG 102/45I:** Modulo 6 giraviti con impronta Torx
- **FG 102/48G:** Modulo 52 inserti con attacco 10mm + adattatore
- **FG 102/65B:** Modulo pinze autobloccanti
- **FG 102/23C:** Modulo 14 utensili rinforzati da 1/2"
- **FG 85/S31:** SET INSERTI DA 1/4" + ADATTATORE PORTA INSERTI 1/4"x1/4"





CARRELLI E BANCHI DA LAVORO



FG 102/03G

~~140,00€~~ **85,00€**

MODULO RIGIDO 14 CHIAVI COMBinate

6, 7, 8, 9, 10, 11, 12, 13, 14, 15, 16, 17, 18, 19 mm



FG 102/03H

MODULO RIGIDO 18 CHIAVI COMBinate

6, 7, 8, 10, 11, 12, 13, 14, 16, 17, 18, 19, 21, 22, 24, 27, 30, 32 mm

~~250,00€~~ **149,00€**



FG 102/03L

~~145,00€~~ **89,00€**

MODULO RIGIDO 6 CHIAVI COMBinate

21, 22, 24, 27, 30, 32 mm



FG 102/03E

MODULO RIGIDO 8 CHIAVI A DOPPIA FORCHETTA

6x7-20x22 mm + 139C/FS

~~80,00€~~ **49,00€**



FG 102/03F

MODULO RIGIDO 5 CHIAVI A DOPPIA FORCHETTA

21x23, 24x26, 25x28, 27x29, 30x32 mm

~~96,00€~~ **59,00€**



FG 102/07C

~~96,00€~~ **59,00€**

MODULO 7 CHIAVI DOPPIE POLIGONALI

6x7, 8x9, 10x11, 12x13, 14x15, 16x17, 18x19mm



FG 102/07D

~~135,00€~~ **79,00€**

MODULO 5 CHIAVI DOPPIE POLIGONALI

20x22, 21x23, 24x27, 25x28, 30x32mm



FG 102/08C

~~245,00€~~ **145,00€**

MODULO 11 CHIAVI COMBinate A CRICCO REVERSIBILE

8, 10, 11, 12, 13, 14, 15, 16, 17, 18, 19mm



FG 102/10C

MODULO 8 CHIAVI A T SNODATE ESAGONALI

7, 8, 10, 11, 13, 14, 17, 19 mm

~~330,00€~~ **199,00€**



FG 102/13C

~~185,00€~~ **109,00€**

MODULO 10 CHIAVI A PIPA ESAGONALI-POLIGONALI

6,7,8,10,11,12,13,14, 17,19mm



FG 102/17

MODULO 18 UTENSILI DA 1/4"

4-14mm

~~132,00€~~ **79,00€**



FG 102/17E

MODULO 65 UTENSILI DA 1/4"

~~265,00€~~ **159,00€**



FG 102/19

MODULO 18 UTENSILI DA 3/8"
8-23mm ESAGONALI

~~200,00€~~ **119,00€**



FG 102/19B

MODULO 18 UTENSILI DA 3/8"
8-23mm POLIGONALI

~~180,00€~~ **109,00€**



FG 102/21B

MODULO 25 UTENSILI DA 1/2"
10-32mm ESAGONALI

~~240,00€~~ **139,00€**



FG 102/21C

MODULO 25 UTENSILI DA 1/2"
10-32mm POLIGONALI

~~240,00€~~ **139,00€**



FG 102/21E

MODULO 16 UTENSILI DA 1/2"
10-32mm ESAGONALI

~~165,00€~~ **99,00€**



FG 102/21D

MODULO 16 UTENSILI DA 1/2"
10-32mm POLIGONALI

~~165,00€~~ **99,00€**



FG 102/21TX

MODULO 44 UTENSILI TORX

~~235,00€~~ **139,00€**



FG 102/21H

**MODULO RIGIDO INSERTI A
BUSSOLA 1/2" ESAGONALI E XZN**

~~200,00€~~ **119,00€**

FG 102/25

**MODULO
9 UTENSILI DA 3/4"**
34-50mm ESAGONALI

~~395,00€~~
239,00€



FG 102/25B

**MODULO
9 UTENSILI DA 3/4"**
34-50mm POLIGONALI

~~395,00€~~
239,00€



FG 102/21R

MODULO INSERTI A BUSSOLA RIBE
R4-R14, LR4.LR14

~~220,00€~~ **135,00€**



FG 102/23C

MODULO 14 UTENSILI RINFORZATI DA 1/2"
10,11,12,13,14,16,17,18,19,21,22,23,24mm + FG 628/PR125

~~145,50€~~ **85,00€**



FG 102/51H

MODULO 7 CHIAVI A T MASCHIO ESAGONALI
10,11,12,2, 2.5, 3, 4, 5, 6, 8mm

~~130,00€~~ **79,00€**



FG 102/39XT

MODULO 3 PINZE SERIE INDUSTRIAL
FG 59/XT180 - FG 61/XT160 - FG 63TXT160

~~96,00€~~ **59,00€**



FG 102/39D

MODULO 3 PINZE CON MANICI IN PVC
FG 59PV/180, FG 61PV/160, FG 63PV/160

~~74,00€~~ **45,00€**



CARRELLI E BANCHI DA LAVORO



FG 102/41C

~~96,00€~~

56,00€

MODULO 4 PINZE PER ANELLI ELASTICI

Capacità: 8-25mm



FG 102/42C

~~106,00€~~

59,90€

MODULO 4 PINZE PER ANELLI ELASTICI

Capacità: 19-60mm



FG 102/45D

~~45,00€~~

26,90€

MODULO 6 GIRAVITI AD INTAGLIO E A CRUCE PHILLIPS

3x100, 4x125, 5.5x150, 6.5x150, PH1x80, PH2x150



FG 102/45E

~~55,00€~~

32,90€

MODULO 8 GIRAVITI AD INTAGLIO E A CRUCE PHILLIPS

3x100, 4x125, 5.5x150, 6.5x150, 6.5x38PH1x80, PH2x150, PH2x38



FG 102/45U

MODULO 12 GIRAVITI AD INTAGLIO E A CRUCE PHILLIPS

2.5x60, 3x75, 4x30, 4x100, 5.5x150, 8x150, PH0x60, PH1x30, PH1x80, PH2x100, PH3x150

~~96,00€~~

57,90€



FG 102/45F

~~52,00€~~

31,90€

MODULO 6 GIRAVITI A CRUCE PHILLIPS

PH0x60, PH1x150, PH2x100, PH2x150, PH3x150, PH2x38



FG 102/45G

~~52,00€~~

31,90€

MODULO 7 GIRAVITI AD INTAGLIO

2.5x60, 3x100, 3.5x100, 4x125, 5.5x150, 5.5x100, 6.5x150



FG 102/45I

~~64,00€~~

38,90€

MODULO 6 GIRAVITI TORX

TX10, TX15, TX20, TX25, TX27, TX30



FG 102/45L

~~65,00€~~

39,00€

MODULO 6 GIRAVITI TORX CON FORO

RTX10, RTX15, RTX20, RTX25, RTX27, RTX30



FG 102/45T

~~75,00€~~

39,00€

MODULO 5 GIRAVITI A BUSSOLA ESAGONALI

FX6, FX7, FX8, FX10, FX13





FG 102/48D

~~95,00€~~ **56,90€**

**MODULO 40 INSERTI DA 1/4"
+ PORTA INSERTI**



FG 102/48G

~~120,00€~~ **72,00€**

**MODULO 52 INSERTI DA 10MM
+ ADATTATORE PER CRICCHETTO DA 1/2"**



FG 102/50F

~~76,00€~~ **45,00€**

**MODULO 6 CHIAVI MASCHIO ESAGONALI
2, 2.5, 3, 4, 5, 6mm**



FG 102/50G

~~76,00€~~ **45,00€**

**MODULO 6 CHIAVI MASCHIO TORX
TX10, TX15, TX20, TX25, TX27, TX30**



FG 102/56C

~~125,00€~~ **75,00€**

**MODULO UTENSILI DA PERCUSSIONE
FG 132/500, FG 136/40, FG 126/SN1, FG 126/SN3**



NEW

FG 102/60D

~~51,00€~~ **29,90€**

**MODULO UTENSILI PER MANUTENZIONE
FG 44/MT5, FG 50/AR, FG 48/LG, FG 79/SP4, FG 497/OP1**



FG 102/62B

~~90,00€~~ **55,00€**

MODULO 5 LIME A TAGLIO MEZZODOLCE



FG 102/VA1

~~15,00€~~ **8,90€**

MODULO PORTA MINUTERIE



FG 102/65B

~~65,00€~~ **39,00€**

**MODULO PINZA AUTOBLOCCANTE
E PINZA REGOLABILE A CERNIERA APERTA**

CARRELLI E BANCHI DA LAVORO



FG 102V/AS183

**CARRELLO PORTA UTENSILI FG 102
A 7 CASSETTI CON ASSORTIMENTO
183 UTENSILI IN MODULI DI GOMMA**

~~2.524,50€~~ **999,00€**

**KG
800** **PORTATA
STATICA**



CODICE

FG 102V/AS183 | FG 102B/AS183 | FG 102R/AS183 | FG 102D/AS183



**4 RUOTE Ø125
(2 GIREVOLI-2 FISSE)**



TOP IN GOMMA



**MANIGLIONE IN
ACCIAIO**

1°CASSETTO

- **FG 100/03G:** Modulo 14 chiavi combinate 6 - 19mm
- **FG 100/VA1:** Modulo porta minuterie
- **FG 100/03E:** Modulo 8 chiavi a forchetta 6x7-20x22mm + set 9 chiavi maschio esagonali



2°CASSETTO

- **FG 100/17E:** Modulo 65 utensili da 1/4"
- **FG 100/VA1:** Modulo porta minuterie
- **FG 100/21B:** Modulo chiavi a bussola esagonali 1/2" 8-32mm + accessori



3°CASSETTO

- **FG 100/39XT:** Modulo 3 pinze assortite - serie industrial
- **FG 100/65B:** Modulo pinze autobloccanti
- **FG 100/48D:** Modulo 40 inserti da 1/4" + porta inserti



4°CASSETTO

- **FG 100/45F:** Modulo 6 giraviti a croce Phillips
- **FG 100/45G:** Modulo 7 giraviti a taglio
- **FG 100/56C:** Modulo utensili da percussione





FG 100VD/AS182

CARRELLO BI COLOR PORTA UTENSILI FG 100 A 7 CASSETTI CON ASSORTIMENTO 182 UTENSILI IN MODULI DI GOMMA

~~2.923,50€~~ **1.199,00€**

NEW

KG 800 PORTATA STATICA



1°CASSETTO

- **FG 100/03G:** Modulo 14 chiavi combinate 6 - 19mm
- **FG 100/VA1:** Modulo porta minuterie
- **FG 100/08C:** Modulo 8 chiavi combinate a cricco

2°CASSETTO

- **FG 100/17:** Modulo utensili con attacco quadro 1/4"
- **FG 100/21TX:** Modulo utensili torx con attacco 1/4" e 1/2"
- **FG 100/21B:** Modulo utensili con attacco quadro 1/2"

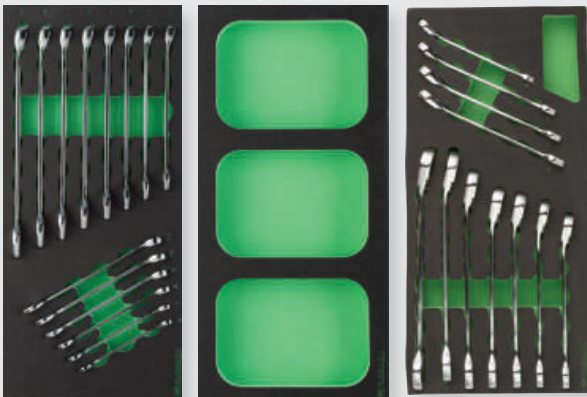

3°CASSETTO

- **FG 100/65B:** Modulo pinze autobloccanti
- **FG 100/45I:** Modulo 6 giraviti con impronta torx
- **FG 100/45D:** Modulo 6 giraviti a taglio e croce

4°CASSETTO

- **FG 100/39XT:** Modulo 3 pinze assortite - serie industrial
- **FG 100/VA1:** Modulo porta minuterie
- **FG 100/48G:** Modulo inserti corti e lunghi con attacco 10mm

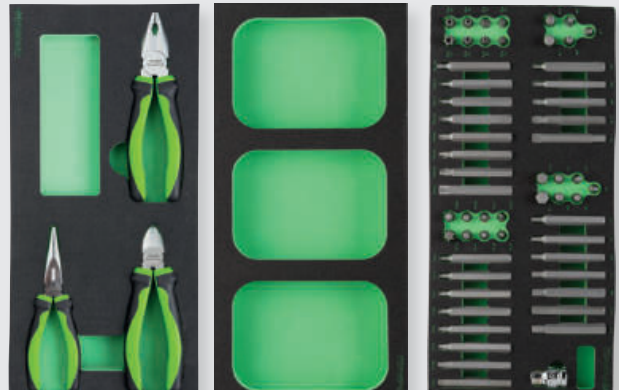

CARRELLI E BANCHI DA LAVORO



FG 100V/AS224

CARRELLO PORTA UTENSILI FG 100
A 7 CASSETTI CON ASSORTIMENTO
224 UTENSILI IN MODULI DI GOMMA

~~2.832,50€~~ **1.199,00€**

**KG
800** PORTATA
STATICA



CODICE

FG 100V/AS224	FG 100B/AS224	FG 100R/AS224	FG 100D/AS224	FG 100W/AS224
---------------	---------------	---------------	---------------	---------------

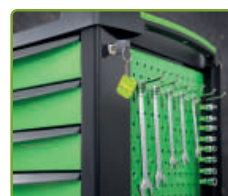

SISTEMA DI CHIUSURA
LATERALE



RIPIANO SUPERIORE
IN ABS



CASSETTO CON
APERTURA COMPLETA

1°CASSETTO

- FG 100/03G: Modulo 14 chiavi combinate 6 - 19mm
- FG 100/17E: Modulo 65 utensili da 1/4"
- FG 100/21B: Modulo chiavi a bussola esagonali 1/2" 8-32mm + accessori

2°CASSETTO

- FG 100/39XT: Modulo 3 pinze assortite - serie industrial
- FG 100/VA1: Modulo porta minuterie
- FG 100/21TX: Modulo 44 utensili TORX



3°CASSETTO

- FG 100/45I: Modulo 6 giraviti con impronta Torx
- FG 100/45D: Modulo 6 giraviti a taglio e croce
- FG 100/48G: Modulo inserti corti e lunghi con attacco 10mm

4°CASSETTO

- FG 100/10C: Modulo 8 chiavi a T snodate 7-19mm

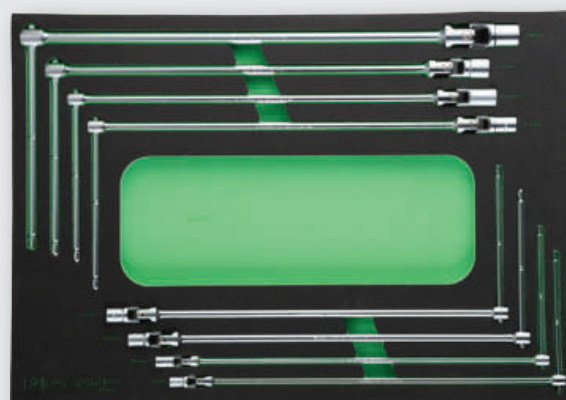



FG 100VD/AS212

**CARRELLO BI COLOR PORTA UTENSILI FG 100
A 7 CASSETTI CON ASSORTIMENTO
212 UTENSILI IN MODULI DI GOMMA**

~~3.390,00€~~ **1.399,00€**

NEW



FG 100RY/AS212 FG 100CW/AS212



FG 100BY/AS212 FG 100GW/AS212



FG 100BW/AS212 FG 100BD/AS212 FG 100RD/AS212



2°CASSETTO

- FG 100/17: Modulo utensili con attacco quadro 1/4"
- FG 100/21TX: Modulo utensili torx con attacco 1/4" e 1/2"
- FG 100/21B: Modulo utensili con attacco quadro 1/2"



3°CASSETTO

- FG 100/81F: Modulo inserti a bussola con attacco quadro 1/2"
- FG 100/45I: Modulo 6 giraviti con impronta torx
- FG 100/45D: Modulo 6 giraviti a taglio e croce



4°CASSETTO

- FG 100/39XT: Modulo 3 pinze assortite - serie industrial
- FG 100/65B: Modulo pinze autobloccanti
- FG 100/48G: Modulo inserti corti e lunghi con attacco 10mm



5°CASSETTO

- FG 100/10C: Modulo 8 chiavi a T snodate 7-19mm





CARRELLI E BANCHI DA LAVORO



FG 150R/AS167

**CARRELLO PORTA UTENSILI
A 7 CASSETTI CON ASSORTIMENTO
167 UTENSILI IN MODULI DI GOMMA**

~~3.004,00€~~ **1.299,00€**

1°CASSETTO

- **FG 100/03G:** Modulo 14 chiavi combinate 6 - 19mm
- **FG 100/VA1:** Modulo di riempimento con vani porta minuteria
- **FG 100/03E:** Modulo 8 chiavi a forchetta 6x7-20x22mm
+ set 9 chiavi maschio esagonali



3°CASSETTO

- **FG 100/81F:** Modulo inserti a bussola da 1/2" esagonali e XZN
- **FG 100/42C:** Modulo 4 pinze per anelli elastici 19-60mm
- **FG 100/65B:** Modulo pinze autobloccanti e a cerniera



5°CASSETTO

- **FG 100/10C:** Modulo 8 chiavi a T snodate 7-19mm

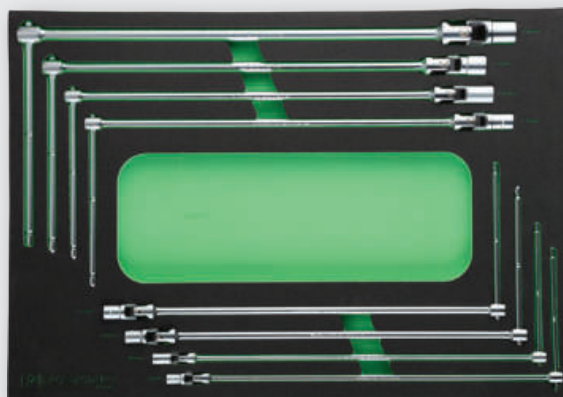

CODICE

FG 150R/AS167 FG 150D/AS167

**KG
800**

**PORTATA
STATICA**

2°CASSETTO

- **FG 100/17:** Modulo 11 chiavi a bussola da 1/4" esagonali + accessori
- **FG 100/21TX:** Modulo 44 utensili con impronta TORX
- **FG 100/21B:** Modulo chiavi a bussola esagonali 1/2" 8-32mm + accessori



4°CASSETTO

- **FG 100/39XT:** Modulo 3 pinze assortite - serie industrial
- **FG 100/VA1:** Modulo di riempimento con vani porta minuteria
- **FG 100/45D:** Modulo 6 giraviti ad intaglio e a croce phillips





CODICE

FG 100V/AS230 FG 100B/AS230 FG 100R/AS230 FG 100D/AS230 FG 100W/AS230

2°CASSETTO

- FG 100/17E: Modulo 65 utensili da 1/4"
- FG 100/21TX: Modulo 44 utensili con impronta Torx
- FG 100/21B: Modulo chiavi a bussola esagonali 1/2" 8-32mm + accessori



4°CASSETTO

- FG 100/39XT: Modulo 3 pinze assortite - serie industrial
- FG 100/45D: Modulo 6 giraviti ad intaglio e a croce phillips
- FG 100/45I: Modulo 6 giraviti con impronta TORX



FG 100V/AS230

**CARRELLO PORTA UTENSILI FG 100
7 CASSETTI CON ASSORTIMENTO
230 UTENSILI IN MODULI IN GOMMA**

~~3.510,50€~~ **1.399,00€**

KG 800 **PORTATA STATICA**

1°CASSETTO

- FG 100/03G: Modulo 14 chiavi combinate 6 - 19mm
- FG 100/03L: Modulo 6 chiavi combinate
- FG 100/03E: Modulo 8 chiavi a forchetta 6x7-20x22mm + set 9 chiavi maschio esagonali



3°CASSETTO

- FG 100/81F: Modulo inserti a bussola da 1/2" esagonali e XZN
- FG 100/65B: Modulo pinze autobloccanti
- FG 100/42C: Modulo 4 pinze per anelli elastici 19-60mm



5°CASSETTO

- FG 100/10D: Modulo 12 chiavi a T snodate



CARRELLI E BANCHI DA LAVORO



FG 100V/AS366

CARRELLO PORTA UTENSILI FG 100
A 7 CASSETTI CON ASSORTIMENTO
366 UTENSILI IN MODULI RIGIDI

~~3.849,30€~~ 1.499,00€



PORTATA
STATICA



CODICE

FG 100V/AS366 FG 100B/AS366 FG 100R/AS366 FG 100D/AS366 FG 100W/AS366



SISTEMA DI CHIUSURA
LATERALE

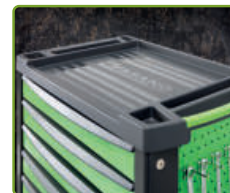

RIPIANO SUPERIORE
IN ABS



CASSETTO CON
APERTURA COMPLETA

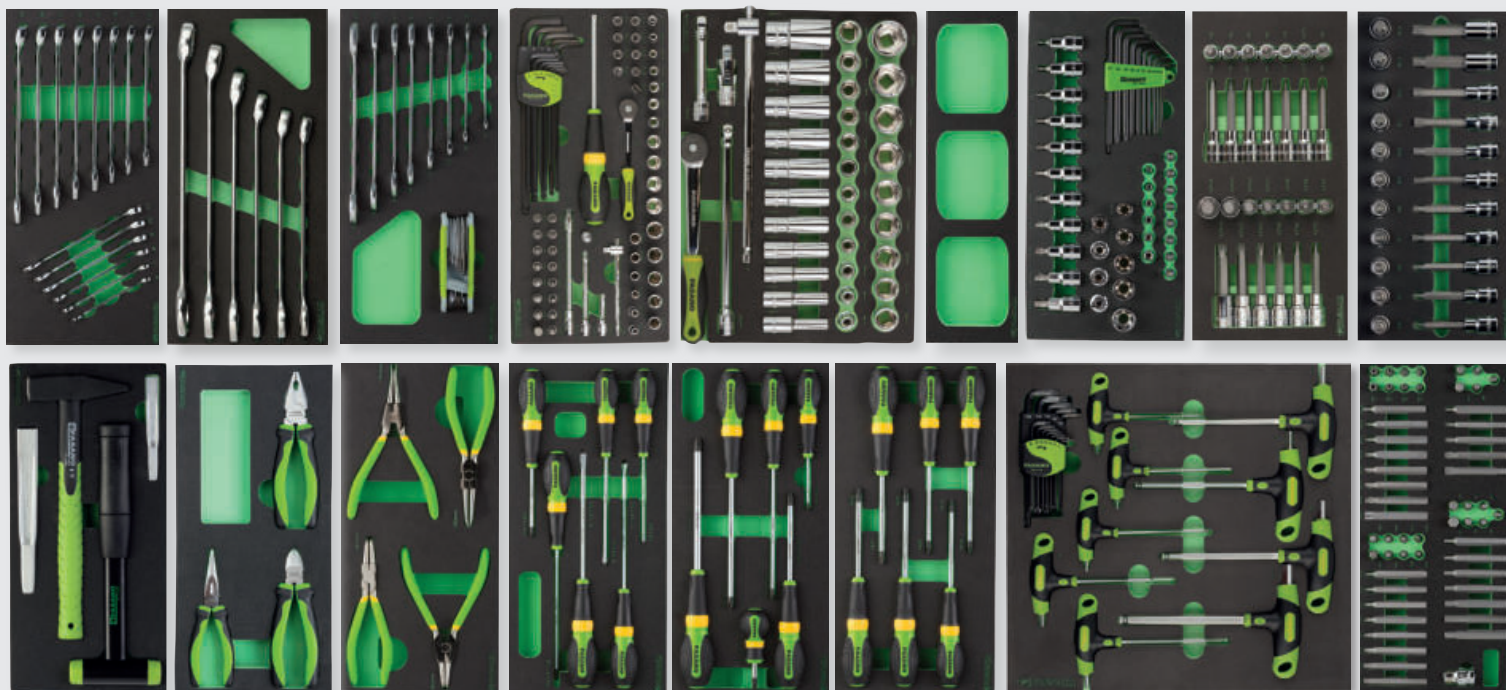

- FG 100/03G: Modulo 14 chiavi combinate 6 - 19mm
- FG 100/03L: Modulo rigido 6 chiavi combinate
- FG 100/03E: Modulo 8 chiavi doppia forchetta
- FG 100/17E: Modulo 65 utensili da 1/4"
- FG 100/21H: Modulo utensili con attacco quadro 1/2"
- FG 100/VA4: Modulo vuoto porta minuterie
- FG 100/21TX: Modulo utensili torx con attacco 1/4" e 1/2"
- FG 100/81F: Modulo inserti a bussola esagonali e xzn con attacco 1/2"
- FG 100/82B: Modulo inserti a bussola ribe con attacco 1/2"

- FG 100/56C: Modulo utensili da percussione
- FG 100/39XT: Modulo 3 pinze assortite - serie industrial
- FG 100/42C: Modulo 4 pinze per anelli elastici
- FG 100/45G: Modulo 7 giraviti con testa ad intaglio
- FG 100/45F: Modulo 6 giraviti con testa a croce phillips
- FG 100/45I: Modulo 6 giraviti con impronta Torx
- FG 100/50E: Modulo chiavi maschio esagonali e Torx
- FG 100/48G: Modulo 52 inserti con attacco 10mm + adattatore
- FG 85/S31: SET INSERTI DA 1/4" + ADATTATORE PORTA INSERTI 1/4"x1/4"





FG 100VD/AS355

~~4.138,90€~~ **1.599,00€**

CARRELLO BI COLOR PORTA UTENSILI FG 100 A 7 CASSETTI CON ASSORTIMENTO 355 UTENSILI IN MODULI DI GOMMA

NEW

KG 800 PORTATA **STATICA**



- **FG 100/03G:** Modulo 14 chiavi combinate 6 - 19mm
- **FG 100/07C:** Modulo 7 chiavi doppie poligonali
- **FG 100/03E:** Modulo 8 chiavi doppia forchetta
- **FG 100/17E:** Modulo 65 utensili da 1/4"
- **FG 100/19:** Modulo utensili con attacco quadro 3/8"
- **FG 100/21B:** Modulo utensili con attacco quadro 1/2"
- **FG 100/21TX:** Modulo utensili torx con attacco 1/4" e 1/2"
- **FG 100/81F:** Modulo inserti a bussola esagonali e xzn con attacco 1/2"
- **FG 100/82B:** Modulo inserti a bussola ribe con attacco 1/2"

- **FG 100/48G:** Modulo 52 inserti con attacco 10mm + adattatore
- **FG 100/45I:** Modulo 6 giraviti con impronta Torx
- **FG 100/45D:** Modulo 6 giraviti taglio e croce
- **FG 100/65B:** Modulo pinze autobloccanti
- **FG 100/42C:** Modulo 4 pinze per anelli elastici
- **FG 100/39XT:** Modulo 3 pinze assortite - serie industrial
- **FG 100/10C:** Modulo 8 chiavi a T snodate 7-19mm
- **FG 85/S31:** SET INSERTI DA 1/4" + ADATTATORE PORTA INSERTI 1/4"x1/4"

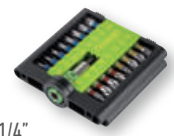

CARRELLI E BANCHI DA LAVORO



KG
1000

**PORTATA
STATICA**

FG 104D/AS242

**CARRELLO PORTA UTENSILI FG 104
A 7 CASSETTI CON ASSORTIMENTO
246 UTENSILI IN MODULI DI GOMMA**

~~3.928,00€~~ **1.499,00€**



CODICE

FG 104V/AS242 FG 104D/AS242 FG 104B/AS242 FG 104R/AS242



**MANIGLIONE IN
ACCIAIO INOX**



**CHIUSURA
CENTRALIZZATA**

1°CASSETTO

- **FG 100/03G:** Modulo 14 chiavi combinate 6 - 19mm
- **FG 100/03L:** Modulo 6 chiavi combinate 21 - 32mm
- **FG 100/VA4:** Modulo di riempimento con vani porta minuteria
- **FG 100/21H:** Modulo 32 chiavi a bussola esagonali da 1/2" 8-32m + acc.



2°CASSETTO

- **FG 100/17E:** Modulo 65 utensili da 1/4"
- **FG 100/21TX:** Modulo 44 utensili con impronta Torx
- **FG 100/81F:** Modulo inserti a bussola da 1/2" esagonali e XZN
- **FG 100/23C:** Modulo 20 chiavi a bussola rinforzate da 1/2"



3°CASSETTO

- **FG 100/42C:** Modulo 4 pinze per anelli elastici 19-60mm
- **FG 100/39XT:** Modulo 3 pinze assortite - serie industrial
- **FG 100/45D:** Modulo 6 giraviti ad intaglio e a croce Phillips
- **FG 100/45I:** Modulo 6 giraviti con impronta Torx



4°CASSETTO

- **FG 100/65B:** Modulo pinza autobloccante e pinza regolabile a cerniera
- **FG 100/10C:** Modulo 8 chiavi a T snodate esagonali

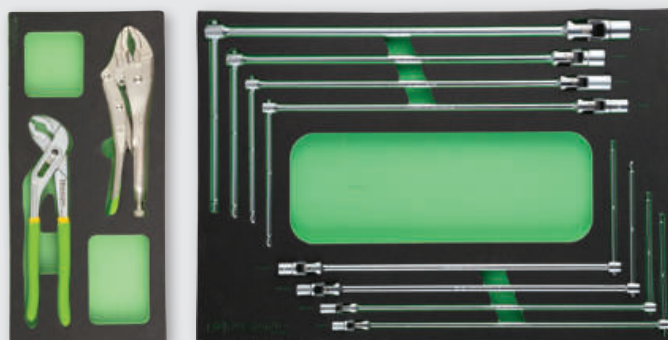



FG 160V/AS290

**CARRELLO PORTA UTENSILI A 14 CASSETTI
MOD. FG 160 CON ASSORTIMENTO
290 UTENSILI IN MODULI DI GOMMA**

~~6.098,50€~~ **2.999,00€**



CODICE

FG 160B/AS290 FG 160R/AS290 FG 160D/AS290

**KG
2.400**

**PORTATA
STATICA**

6 CASSETTI COMPLETI DI UTENSILI



- FG 100/03H: Modulo 18 chiavi combinate in mm
- FG 100/17E: Modulo 65 utensili da 1/4"
- FG 100/21B: Modulo 25 utensili da 1/2"
- FG 100/21TX: Modulo 44 utensili con impronta Torx
- FG 100/19: Modulo chiavi a bussola esagonali
- FG 100/81F: Modulo inserti a bussola da 1/2" esagonali e XZN
- FG 100/VA1: Modulo di riempimento con vani porta minuteria
- FG 100/48G: Modulo 52 inserti da 10mm

- FG 100/45I: Modulo 6 giraviti con impronta TORX
- FG 100/45T: Modulo 5 giraviti a bussola esagonali
- FG 100/45D: Modulo 6 giraviti taglio e croce
- FG 100/65B: Modulo pinza autobloccante e pinza regolabile a cerniera aperta
- FG 100/39XT: Modulo 3 pinze assortite - serie industrial
- FG 100/45M: Modulo 6 giraviti a testa esagonale
- FG 100/10C: Modulo 8 chiavi a T snodate 7-19mm

CARRELLI ASSORTITI SETTORE CARROZZERIA



FG 100V/AS171

~~2.851,00€~~ **1.149,00€**

**CARRELLO PORTA UTENSILI FG 100 6 CASSETTI
CON ASSORTIMENTO 171 UTENSILI IN MODULI IN GOMMA**

KG 800 PORTATA
STATICA

1°CASSETTO

- FG 100/03G: Modulo 14 chiavi combinate 6 - 19mm
- FG 100/17E: Modulo utensili con attacco quadro 1/4"
- FG 100/39C: Modulo 3 pinze con manici rivestiti



CODICE

FG 100V/AS171	FG 100B/AS171	FG 100R/AS171	FG 100D/AS171	FG 100W/AS171
---------------	---------------	---------------	---------------	---------------

2°CASSETTO

- FG 100/45I: Modulo 6 giraviti con testa con impronta torx
- FG 100/52F: Modulo 5 raschietti in acciaio con manico in abs
- FG 100/52G: Modulo 5 utensili carrozzeria



3°CASSETTO

- FG 100/52A: Modulo 8 levapioli
- FG 100/52B: Modulo 26 utensili da taglio per carrozzeria
- FG 100/VA4: Modulo vuoto porta minuterie



4°CASSETTO

- FG 100/52C: Modulo 5 utensili per cristalli veicoli
- FG 100/52D: Modulo 10 leve in nylon
- FG 100/52E: Modulo 5 cunei in plastica



5°CASSETTO

- FG 100/52H: Modulo utensili manutenzione per carrozzeria





FG 104V/AS284

**CARRELLO PORTA UTENSILI FG 104
7 CASSETTI CON ASSORTIMENTO 284
UTENSILI IN MODULI IN GOMMA**

~~4.300,00€~~ **1.599,00€**



CODICE

FG 104V/AS284 FG 104D/AS284 FG 104B/AS284 FG 104R/AS284

KG 1000 **PORTATA STATICA**

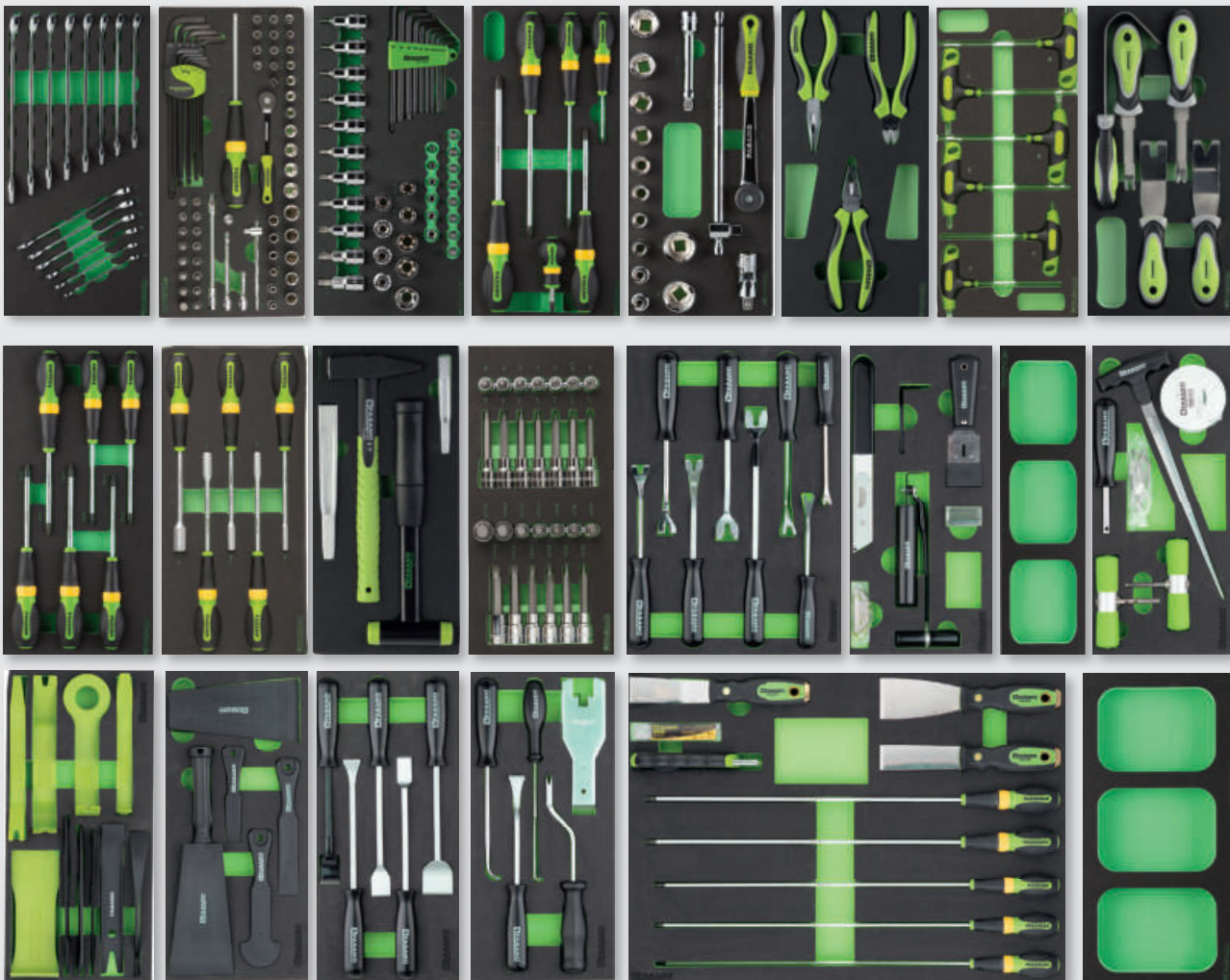

- FG 100/03G: Modulo 14 chiavi combinate
- FG 100/17E: Modulo 65 utensili da 1/4"
- FG 100/21TX: Modulo 44 utensili con impronta Torx
- FG 100/45F: Modulo 6 giraviti con testa a croce phillips
- FG 100/21M: Modulo chiavi a bussola esagonali
- FG 100/39C: modulo 3 pinze con manici rivestiti in bi-materiale
- FG 100/50G: Modulo 6 chiavi maschio torx
- FG 100/68: Modulo 5 levapioli
- FG 100/45I: Modulo 6 giraviti con impronta TORX
- FG 100/45T: Modulo 5 giraviti a bussola esagonali
- FG 100/56C: Modulo utensili da percussione
- FG 100/81F: Modulo inserti a bussola da 1/2" esagonali e XZN

- FG 100/52A: Modulo 8 levapioli
- FG 100/52B: Modulo 26 utensili da taglio per carrozzeria
- FG 100/VA4: Modulo vuoto porta minuterie
- FG 100/52C: Modulo 5 utensili per cristalli veicoli
- FG 100/52D: Modulo 10 leve in nylon
- FG 100/52E: Modulo 5 cunei in plastica
- FG 100/52F: Modulo 5 raschietti in acciaio con manico in abs
- FG 100/52G: Modulo 5 utensili carrozzeria
- FG 100/52H: Modulo utensili manutenzione per carrozzeria
- FG 100/VA1: Modulo vuoto porta minuterie



THE HYBRID REVOLUTION



UTENSILI ESSENZIALI PER AFFRONTARE LE NUOVE SFIDE DEL FUTURO

FG 603/S28A

FG 603/S28B

KIT 26 UTENSILI ISOLATI, COMPLETO DI ELMETTO DIELETTRICO E GUANTI DIELETTRICI 1.000V

IDEALE PER INTERVENTI SU VEICOLI ELETTRICI ED IBRIDI



FG 59/IS200



FG 61/IS200



FG 63/IS160



FG 603/E10,11,12,13,14,17,19



FG 625E/10,11,12,13,14,17,19



FG 22E/AX100, 5.5X125, FG22E/PH1X80, PH2X100



FG 625E/CR12



FG 625E/PR250



FG 49/E



FG 48/IS



FG 22/CF250



 **1000V**
IEC 60900

CODICE	TAGLIA GUANTI	LISTINO	€/PROMO
FG 603/S28A	TAGLIA 9	1.040,50	539,00
FG 603/S28B	TAGLIA 10	1.040,50	539,00

FG 603/TA1

~~278,00€~~

145,00€

TAPPETO ISOLANTE 1000V
- 1.000x1.000x3mm



**ASSORTIMENTO 56
UTENSILI ISOLATI**



**KG
600** PORTATA
STATICA

FG 100V/AS56

CARRELLO PORTA UTENSILI FG 100 A 6 CASSETTI CON ASSORTIMENTO 56 UTENSILI ISOLATI IN MODULI IN GOMMA

~~2.948,60€~~ **1.299,00€**

1°CASSETTO

- **FG 100/03-IS: Modulo chiavi a forchetta e giraviti isolati**
- Chiavi a forchetta isolate 7-19mm
- Giraviti isolati a taglio 2.5x75mm, 3x100mm, 5.5x125mm, 6.5x150mm, 8x175mm
- Giraviti isolati per viti a croce Phillips PH0x60, PH1x80, PH2x100, PH3x150

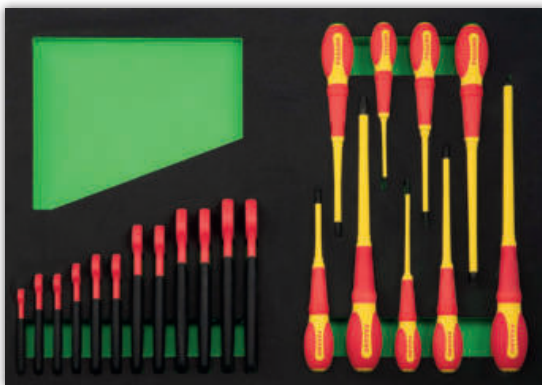

2°CASSETTO

- **FG 100/21-IS: Modulo bussole da 1/2 e accessori isolati**
- Chiavi a bussola esagonali da 1/2" 10-32mm
- Inserti a bussola esagonali corti e lunghi da 1/2" 4-10mm
- Accessori da 1/2"



3°CASSETTO

- **FG 100/39-IS: Modulo pinze e utensili da taglio isolati**
- Pinze assortite e tronchese diagonale isolate
- Forbice con manici isolati
- Cutter professionale isolato
- Spellacavi elicoidale

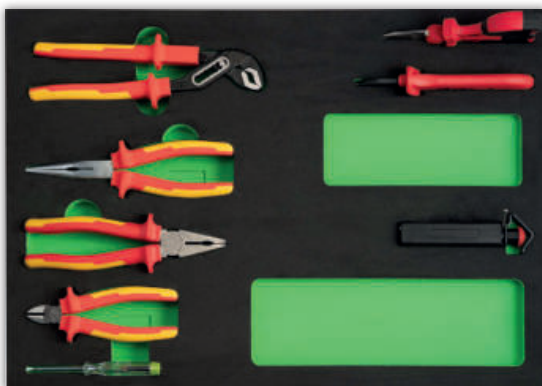

**SCEGLI TRA 5 VARIANTI DI COLORE
LA TUA PREFERITA!**

Il nuovo carrello porta utensili FG 100 a 6 cassetti è ancora più performante e presenta **un assortimento di 56 UTENSILI ISOLATI** in moduli in gomma, **INDISPENSABILI PER LA MANUTENZIONE DI VEICOLI ELETTRICI E IBRIDI.**



CODICE				
FG 100V/AS56	FG 100B/AS56	FG 100R/AS56	FG 100D/AS56	FG 100W/AS56

SPECIALE VEICOLI ELETTRICI



FG 100/03G

~~160,00€~~ **89,00€**

MODULO 14 CHIAVI COMBinate

6, 7, 8, 9, 10, 11, 12, 13, 14, 15, 16, 17, 18, 19 mm



FG 100/03H

MODULO 18 CHIAVI COMBinate IN mm

FG 600/B6,7,8,10,11,12,13,14,16,
17,18,19,21,22,24,27,30,32mm

~~295,00€~~ **175,00€**



FG 100/03L

~~158,00€~~ **89,00€**

MODULO 6 CHIAVI COMBinate

21, 22, 24, 27, 30, 32mm



FG 100/03E

**MODULO 8 CHIAVI
A DOPPIA FORCHETTA
A DOPPIA FORCHETTA
IMPRONTA ESAGONALE**

6x7-20x22 mm + 139C/FS

~~95,00€~~ **56,00€**



FG 100/03F

**MODULO 5 CHIAVI
A DOPPIA FORCHETTA**

21x23, 24x26, 25x28, 27x29, 30x32 mm

~~105,00€~~ **62,00€**

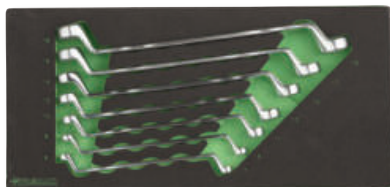

FG 100/07C

MODULO 7 CHIAVI DOPPIE POLIGONALI

6x7, 8x9, 10x11, 12x13, 14x15, 16x17, 18x19mm

~~109,60€~~ **59,00€**



FG 100/07D

MODULO 5 CHIAVI DOPPIE POLIGONALI

FG 615/B20x22,21x23,24x27,25x28,30x32mm

~~155,00€~~ **95,00€**



FG 100/08C

MODULO 8 CHIAVI COMBinate A CRICCO

8, 10, 11, 12, 13, 14, 15, 16, 17, 18, 19mm

~~245,00€~~ **145,00€**

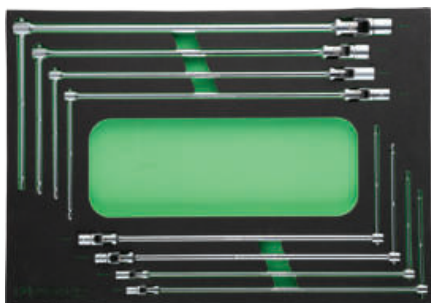

FG 100/10C

**MODULO 8 CHIAVI A
T SNODATE ESAGONALI**

7, 8, 10, 11, 13, 14, 17, 19 mm

~~377,50€~~
229,00€

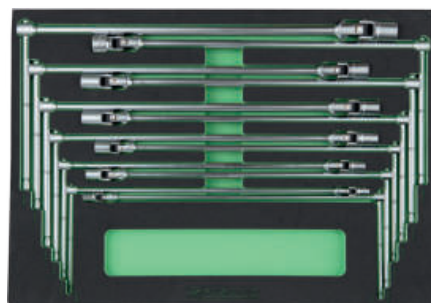

FG 100/10D

**MODULO 12 CHIAVI A
T SNODATE ESAGONALI**

7, 8, 10, 11, 12,13, 14, 15, 16,
17, 18, 19 mm

~~549,00€~~
329,00€



FG 100/17

MODULO 18 UTENSILI DA 1/4"

4-14mm

~~142,00€~~ **79,00€**



FG 100/17E

MODULO 65 UTENSILI DA 1/4"

~~285,00€~~ **169,00€**



FG 100/18

**MODULO CHIAVI
A BUSSOLA ESAGONALI**

~~295,00€~~ **179,00€**



FG 100/19

**MODULO CHIAVI
A BUSSOLA ESAGONALI**

~~230,00€~~ **139,00€**



FG 100/21B

MODULO 25 UTENSILI DA 1/2"
10-32mm ESAGONALI

~~245,00€~~ **145,00€**



FG 100/21C

MODULO 25 UTENSILI DA 1/2"
10-32mm POLIGONALI

~~245,00€~~ **145,00€**

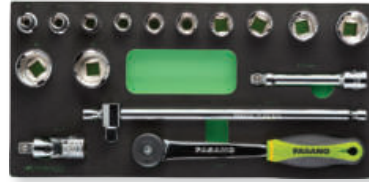

FG 100/21M

MODULO 16 UTENSILI DA 1/2"
10-32mm ESAGONALI

~~165,00€~~ **99,00€**



FG 100/21D

MODULO 16 UTENSILI DA 1/2"
10-32mm POLIGONALI

~~165,00€~~ **99,00€**



FG 100/21H

MODULO 32 CHIAVI A BUSSOLA
ESAGONALI 1/2" + ACCESSORI
BUSSOLE CORTE: 8-32mm
(esclusa 25mm)
BUSSOLE LUNGHE: 10-32mm

~~430,00€~~ **259,00€**



FG 100/21TX

MODULO 44 UTENSILI TORX

~~260,00€~~ **155,00€**

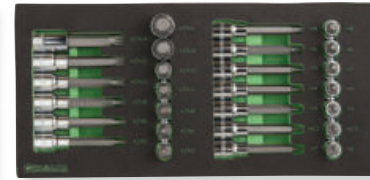

FG 100/81F

MODULO INSERTI A BUSSOLA
DA 1/2" ESAGONALI XZN

~~200,00€~~ **119,00€**



FG 100/23B

MODULO 9 UTENSILI DA 3/4"
34-50mm ESAGONALI

~~360,00€~~ **219,00€**

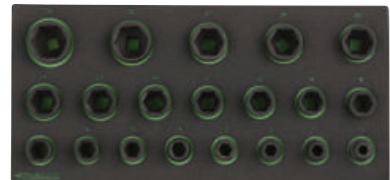

FG 100/23C

MODULO 20 UTENSILI RINFORZATI DA 1/2"

10, 11, 12, 13, 14, 15, 16, 17, 18, 19, 20, 21, 22, 23, 24, 25, 26, 27, 30, 32mm

~~220,00€~~ **129,00€**



FG 100/39XT

MODULO 3 PINZE ASSORTITE
- SERIE INDUSTRIAL

FG 59/XT180 - FG 61/XT160 - FG 63/XT160

~~104,00€~~ **62,90€**



FG 100/65B

MODULO PINZA AUTOBLOCCANTE
E PINZA REGOLABILE
A CERNIERA APERTA

~~92,50€~~ **49,90€**



FG 100/65C

MODULO PINZE AUTOBLOCCANTI
FG 70/CJ250 - FG 58/A240 - FG 49/HE250

~~131,80€~~ **79,00€**



FG 100/41C

MODULO 4 PINZE PER ANELLI ELASTICI
Capacità: 8-25mm

~~110,00€~~ **65,00€**



FG 100/42C

MODULO 4 PINZE PER ANELLI ELASTICI
Capacità: 19-60mm

~~115,00€~~ **69,00€**

CARRELLI E BANCHI DA LAVORO



FG 100/45D

~~65,00€~~ **39,00€**

MODULO 6 GIRAVITI AD INTAGLIO E A CROCE PHILLIPS

3x100, 4x125, 5.5x150, 6.5x150, PH1x80, PH2x150



FG 100/45E

~~80,00€~~ **49,00€**

MODULO 8 GIRAVITI AD INTAGLIO E A CROCE PHILLIPS

3x100, 4x125, 5.5x150, 6.5x150, 6.5x38PH1x80, PH2x150, PH2x38



FG 100/45I

~~82,00€~~ **49,00€**

MODULO 6 GIRAVITI TORX

TX10, TX15, TX20, TX25, TX27, TX30



FG 100/45T

~~85,00€~~ **52,00€**

MODULO 5 GIRAVITI A BUSSOLA ESAGONALI

FX6, FX7, FX8, FX10, FX13

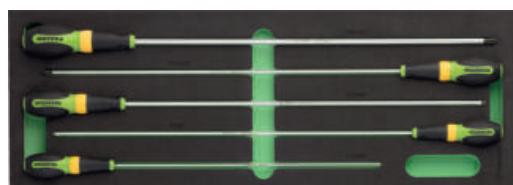

FG 100/45H

~~80,00€~~ **49,00€**

MODULO 5 GIRAVITI EXTRA LUNGHI

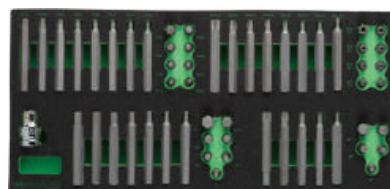

FG 100/48G

~~130,00€~~ **79,00€**

MODULO 52 INSERTI DA 10MM



FG 100/51H

MODULO 7 CHIAVI MASCHIO ESAGONALI

2, 5, 3, 4, 5, 6, 8mm



~~145,00€~~ **89,00€**



FG 100/54

MODULO 5 UTENSILI DI MISURAZIONE

~~170,00€~~ **99,00€**



FG 100/56C

MODULO UTENSILI DA PERCUSSIONE

FG 132/500, FG 136/40, FG 126/SN1, FG 126/SN3

~~135,00€~~ **79,90€**



FG 100/55B

MODULO UTENSILI DA PERCUSSIONE

FG 135/45 - FG 136-40

~~120,00€~~ **72,00€**



FG 100/76C

MODULO TAPPI E CHIAVI FILTRI OLIO

FG 176/F01 - FG 176/RE - FG 175/S15



~~274,00€~~ **165,00€**



FG 100/VA1

MODULO VUOTO PORTA MINUTERIE

~~24,00€~~ **14,50€**

FG 106/A
CARRELLO PORTA ATTREZZI IN LAMIERA D'ACCIAIO

- Dimensione: 350x750x957mm
- Lamiera d'acciaio 1.5mm
- Ruote montate su supporto rotante a piastra con gruppo rotante realizzato con doppia corona di sfere
- 2 ruote fisse, 1 girevole + 1 girevole con freno (Ø80mm)
- Peso totale: 19.5Kg

~~250,00€~~
129,00€

FG 106/B
CARRELLO PORTA ATTREZZI IN LAMIERA D'ACCIAIO

- Dimensione: 460x930x885mm
- Lamiera d'acciaio 1.5mm
- Ruote montate su supporto rotante a piastra con gruppo rotante realizzato con doppia corona di sfere
- 2 ruote fisse, 1 girevole + 1 girevole con freno (Ø100mm)
- Peso totale: 22.0Kg

~~300,00€~~
159,00€

FG 106/C
CARRELLO PORTA ATTREZZI IN LAMIERA D'ACCIAIO - MOD. GIGANTE

- Dimensione: 560x1.000x950mm
- Lamiera d'acciaio 2.0mm
- Ruote montate su supporto rotante a piastra con gruppo rotante realizzato con doppia corona di sfere
- 2 ruote fisse, 1 girevole + 1 girevole con freno (Ø125mm)
- Peso totale: 44.0Kg

~~390,00€~~
199,00€



CARRELLI E BANCHI DA LAVORO

GAMMA FG 128

FG 128/2

BANCO DA LAVORO 2MT SENZA CASSETTI

Peso totale: 59,5Kg
Portata statica: 2000Kg
Dimensioni: 2.000x670x880mm

~~700,00€~~ **349,00€**

LAMIERA
D'ACCIAIO
DA 2mm



MADE IN ITALY

PROFONDITA'
670mm

DISPONIBILE CON DUE CASSETTI IN TRE VARIANTI COLORE

FG 128/D2

BANCO DA LAVORO 2MT DOTATO DI 2 CASSETTI

Peso totale: 74,5Kg
Portata statica: 2000Kg
Dimensioni: 2.000x670x880mm

~~950,00€~~ **479,00€**



FG 128/D2

FG 128/B2

FG 128/R2

KG
2000

MADE IN ITALY



GAMMA FG 129

FG 129/2

BANCO DA LAVORO 2MT SENZA CASSETTI

Peso totale: 77Kg
Portata statica: 2000Kg
Dimensioni: 2.000x745x880mm

~~850,00€~~ **449,00€**

LAMIERA
D'ACCIAIO
DA 3mm



MADE IN ITALY

PROFONDITA'
745mm

DISPONIBILE CON DUE CASSETTI IN TRE VARIANTI COLORE

FG 129/D2

BANCO DA LAVORO 2MT DOTATO DI 2 CASSETTI

Peso totale: 92Kg
Portata statica: 2000Kg
Dimensioni: 2.000x745x880mm

~~1.100,00€~~ **579,00€**



FG 129/D2

FG 129/B2

FG 129/R2

KG
2000

MADE IN ITALY



FG 129/1
~~550,00€~~ **289,00€**
BANCO DA LAVORO 1MT

Ripiano superiore in lamiera d'acciaio zincato da 3mm
 Ripiano inferiore in lamiera d'acciaio fornita di serie
 2 montanti
 Predisposizione per fissaggio a pavimento
 Struttura verniciata con vernice epossidica

Peso totale: 58Kg
 Portata statica: 2000Kg
 Dimensioni: **1.000x745x880mm**

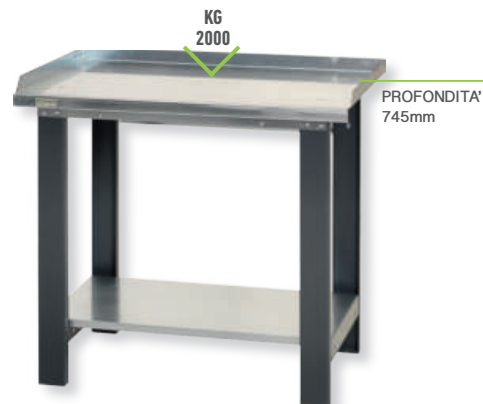
MADE IN ITALY
FG 129/D1
~~620,00€~~ **359,00€**
BANCO DA LAVORO 1MT DOTATO DI 1 CASSETTO

Ripiano superiore in lamiera d'acciaio zincato da 3mm
 Ripiano inferiore in lamiera d'acciaio fornita di serie
 2 montanti
 Predisposizione per fissaggio a pavimento
 Struttura verniciata con vernice epossidica

Peso totale: 64,5Kg
 Portata statica: 2000Kg
 Dimensioni: **1.000x745x880mm**

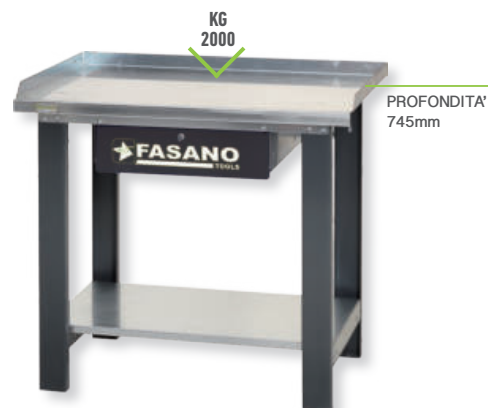
FG 129/D1
FG 129/B1
FG 129/R1

MADE IN ITALY
FG 129/1.5
~~650,00€~~ **339,00€**
BANCO DA LAVORO 1.5MT

Ripiano superiore in lamiera d'acciaio zincato da 3mm
 Ripiano inferiore in lamiera d'acciaio fornita di serie
 2 montanti
 Predisposizione per fissaggio a pavimento
 Struttura verniciata con vernice epossidica

Peso totale: 77Kg
 Portata statica: 2000Kg
 Dimensioni: **1.500x745x880mm**

MADE IN ITALY
FG 129/D1.5
~~720,00€~~ **419,00€**

Ripiano superiore in lamiera d'acciaio zincato da 3mm
 Ripiano inferiore in lamiera d'acciaio fornita di serie
 2 montanti
 Predisposizione per fissaggio a pavimento
 Struttura verniciata con vernice epossidica

Peso totale: 83,5Kg
 Portata statica: 2000Kg
 Dimensioni: **1.500x745x880mm**

FG 129/D1.5
FG 129/B1.5
FG 129/R1.5

MADE IN ITALY



CARRELLI E BANCHI DA LAVORO

FG 129/D1-R

~~815,00€~~ **399,00€**

NEW

BANCO DA LAVORO 1MT DOTATO DI 1 CASSETTO E RUOTE GIREVOLI

Ripiano superiore in lamiera d'acciaio zincato da 3mm
Ripiano inferiore in lamiera d'acciaio fornita di serie
2 montanti
Predisposizione per fissaggio a pavimento
Struttura verniciata con vernice epossidica
Con 4 ruote girevoli (2 frenanti)

Peso totale: 69,5Kg
Portata statica: 2000Kg
Dimensioni: 1.000x745x880mm



FG 129/D1-R

FG 129/B1-R

FG 129/R1-R

KG
2000



MADE IN ITALY

FG 129/D1.5-R

~~915,00€~~ **459,00€**

BANCO DA LAVORO 1MT DOTATO DI 1 CASSETTO E RUOTE GIREVOLI

Ripiano superiore in lamiera d'acciaio zincato da 3mm
Ripiano inferiore in lamiera d'acciaio fornita di serie
2 montanti
Predisposizione per fissaggio a pavimento
Struttura verniciata con vernice epossidica
Con 4 ruote girevoli (2 frenanti)

Peso totale: 88,5Kg
Portata statica: 2000Kg
Dimensioni: 1.500x745x880mm



FG 129/D1.5-R

FG 129/B1.5-R

FG 129/R1.5-R

KG
2000



NEW

MADE IN ITALY

FG 129/D2-R

~~1.270,00€~~ **639,00€**

BANCO DA LAVORO 2MT DOTATO DI 2 CASSETTI E RUOTE GIREVOLI

Ripiano superiore in lamiera d'acciaio zincato da 3mm
Ripiano inferiore in lamiera d'acciaio fornita di serie
3 montanti
Predisposizione per fissaggio a pavimento
Struttura verniciata con vernice epossidica
Con 6 ruote girevoli (2 frenanti)

Peso totale: 97Kg
Portata statica: 2000Kg
Dimensioni: 2.000x745x880mm



FG 129/D2-R

FG 129/B2-R

FG 129/R2-R

KG
2000



NEW

MADE IN ITALY



FG 137/D1.5

**BANCO DA LAVORO 1.5MT
CON VASCA DI RACCOLTA
DI COLORE GRIGIO DARK
E RUOTE GIREVOLI**

Peso totale: 90,00Kg
Dimensione: 1.500x745x880mm

~~1.400,80€~~ **739,00€**

MADE IN ITALY

RIPIANO MICRO FORATO

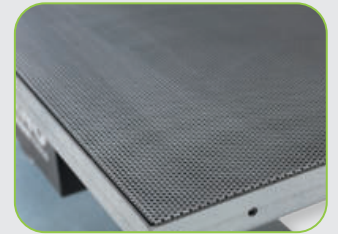

FG 137/R1.5



FG 137/B1.5

BANCO DA LAVORO CON 1 CASSETTIERA A 5 CASSETTI

KG
2000



FG 131/D2

**BANCO DA LAVORO 2.0MT CON RIPIANO
IN ACCIAIO E CASSETTIERA A 5 CASSETTI**

Peso totale: 121.50Kg
Portata statica: 2.000Kg
Dimensioni: 2.000x670x920mm

~~1.700,00€~~ **899,00€**

MADE IN ITALY



FG 131/B2



FG 131/R2



ARREDAMENTO TECNICO



Il meglio del made in Italy

RAL 6018

RAL 5002

RAL 3001

Personalizza i tuoi spazi di lavoro!

I prodotti Fasano Tools sono frutto di un intenso lavoro di ricerca, sviluppo e progettazione interna. La vasta gamma di prodotti che proponiamo è caratterizzata da attenzione e cura per i dettagli, ma anche da stile e design.



MADE IN ITALY



PRESE IN DOTAZIONE
PRESA 220V A 2 POLI
+ 1 PRESA SHUKO A
2 POLI + USB



MODULO DISTRIBUZIONE
OLIO, DOTATO DI
2 PISTOLE DIGITALI
CONTA LITRI



PISILI DOTATI DI
PISTONI A GAS
PER AGEVOLARE
L'APERTURA/CHIUSURA
DELO SPORTELO



VANO PORTA RIFIUTI
MONTATO SU GUIDE
TELESCOPICHE



PIANO DI LAVORO
IN ACCIAIO INOX
E VASCA DI RACCOLTA
ESTRAIBILE

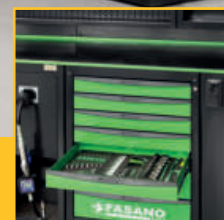

CASSETTI PREDISPOSTI
PER L'INSERIMENTO
DEI MODULI COMPLETI
DI UTENSILI

NEW

FG 118/C014V

**CONFIGURAZIONE DI ARREDAMENTO
TECNICO DA 2.050MM**

CONFIGURAZIONE COMPOSTA DA:

- FG 118V/69A (Modulo armadietto a 2 antine)
- FG 118V/7T (Cassettiera mobile a 7 cassetti)
- FG 118V/40A (Modulo armadietto ad 1 antenna)
- 02 griglie porta utensili
- 02 prese di corrente composte da 1 presa 220V a 2 poli, 1 presa Schuko a 2 poli, USB

~~5.290,00€~~ **2.499,00€**



DIMENSIONI: 2.050X757X2.000mm

MADE IN ITALY



FG 118/C014B



FG 118/C014R

FG 118/C02V

**CONFIGURAZIONE DI ARREDAMENTO
TECNICO DA 2.050MM**

CONFIGURAZIONE COMPOSTA DA:

- FG 118V/69A (Modulo armadietto a 2 antine)
- FG 118V/7T (Cassettiera mobile a 7 cassetti)
- FG 118V/40F (Modulo porta carta, dotato di cassetto porta rifiuti)
- 02 pensili superiori dotati di pistoni a gas e serratura di chiusura
- 02 griglie porta utensili
- 01 presa di corrente composta da 1 presa 220V a 2 poli, 1 presa Schuko a 2 poli, USB

~~5.840,00€~~ **2.999,00€**



DIMENSIONI: 2.050X757X2.000mm

MADE IN ITALY



FG 118/C02B



FG 118/C02R



FG 118/C03V

CONFIGURAZIONE DI ARREDAMENTO TECNICO DA 2.550MM

CONFIGURAZIONE COMPOSTA DA:

- FG 118V/69A (Modulo armadietto a 2 antine)
- FG 118V/7T (Cassettiera mobile a 7 cassetti)
- FG 118V/40F (Modulo porta carta, dotato di cassetto porta rifiuti)
- FG 118/AR1V (Armadietto laterale da 500mm)
- 02 pensili superiori dotati di pistoni a gas e serratura di chiusura
- 02 griglie porta utensili
- 01 presa di corrente composta da 1 presa 220V a 2 poli, 1 presa Schuko a 2 poli, USB

~~6.620,00€~~ **3.399,00€**

DIMENSIONI: 2.550X757X2.000mm

MADE IN ITALY



FG 118/C03B



FG 118/C03R



FG 118/C08V

CONFIGURAZIONE DI ARREDAMENTO TECNICO DA 1.220M DOTATA DI PENSILE SUPERIORE E GRIGLIA PORTA UTENSILI

CONFIGURAZIONE COMPOSTA DA:

- FG 118/69V7 (Cassettiera fissa a 7 cassetti)
- FG 118M/40F (Modulo porta carta, dotato di cassetto porta rifiuti)
- Pensile superiore dotato di pistoni a gas e serratura di chiusura
- 01 griglia porta utensili semplice
- 02 prese di corrente composte da 1 presa 220V a 2 poli, 1 presa Schuko a 2 poli cadauna, USB

~~3.770,00€~~ **1.999,00€**

DIMENSIONI: 1.225X757X2.000mm

MADE IN ITALY



FG 118/C08B



FG 118/C08R



FG 118/C022V

~~15.260,00€~~ **7.900,00€**

**CONFIGURAZIONE DI ARREDAMENTO
TECNICO AD ANGOLO DA 7.160MM**

CONFIGURAZIONE COMPOSTA DA:

- FG 118/AR1V (Armadietto laterale da 500mm)
- FG 118V/69A (Modulo armadietto a 2 ante)
- FG 118V/7T (Cassettiera mobile a 7 cassetti)
- FG 118V/40F (Modulo porta carta, dotato di cassetto porta rifiuti)
- FG 118V/80AN: struttura angolare dotata di griglie porta utensili
- FG 118V/69E (Modulo porta rifiuti)
- FG 118M/40D (Modulo distribuzione aria compressa)
- FG 118/69V7 (Cassettiera fissa a 7 cassetti)
- FG 118/AR2V (Armadietto laterale a due ante)
- 04 pensili superiori dotati di pistoni a gas e serratura di chiusura
- 04 griglie porta utensili
- 02 prese di corrente composte ognuna da 1 presa 220V a 2 poli, 1 presa Schuko a 2 poli, 1 presa USB

NEW

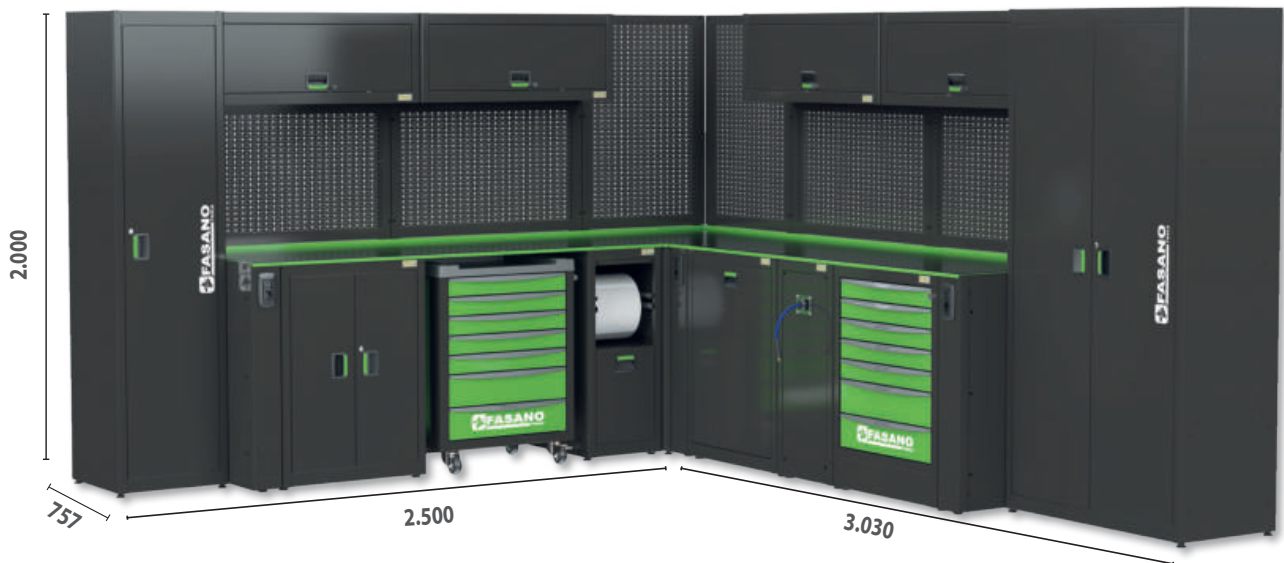
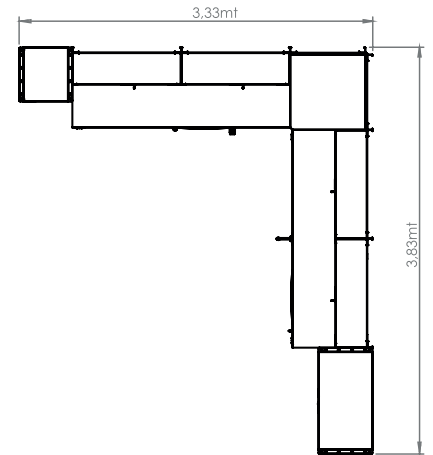

FG 118/C022B



FG 118/C022R



MODULAR FORMS

FG 116



RAL
7021

RAL
6018

13 MODULI SINGOLI
per comporre la configurazione ideale
per il tuo spazio di lavoro

CARRELLI



CASSETTIERE



MODULI MULTIFUNZIONE





POSSIBILITA' DI INSERIRE MODULI DI UTENSILERIA ALL'INTERNO DEI CASSETTI



PIANO DI LAVORO IN ACCIAIO ZINCATO DA 2mm

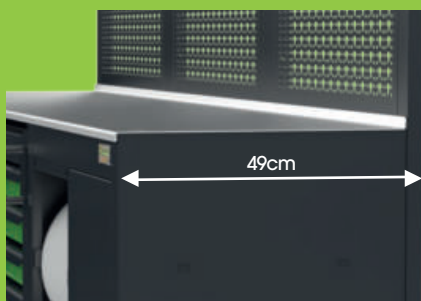

COMPOSIZIONE COMPATTA CON SOLO 49cm DI PROFONDITA'



VANO PORTA RIFIUTI MONTATO SU GUIDE TELESCOPICHE



GRIGLIE PORTA UTENSILI

NUOVO SISTEMA DI ARREDAMENTO TECNICO per l'organizzazione e la personalizzazione del tuo spazio di lavoro

COMPATTEZZA:

49 cm di profondità, ideale per arredare anche gli ambienti meno spaziosi

ROBUSTEZZA:

Spessore del piano di lavoro in acciaio zincato: **2mm**
Spessore struttura in lamiera zincata e verniciata: **1mm**

QUALITÀ:

Struttura per griglie e pensili realizzata con colonne montata sugli stessi moduli per un'elevata resistenza nel tempo

FUNZIONALITÀ:

Cassetti predisposti per l'inserimento dei moduli di utensili Fasano Tools

MADE IN ITALY:

Progettato e realizzato in Italia all'interno dei nostri stabilimenti per garantire cura dei dettagli, stile elegante ed attenzione nella scelta dei materiali

VERSATILITÀ:

Sistema flessibile e modulabile, con possibilità di completa personalizzazione oppure scelta di combinazioni predeterminate ampliabili o modificabili nel tempo.



4 TIPOLOGIE DI STRUTTURA BASE

MADE IN ITALY

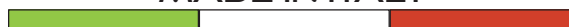

CONFIGURAZIONI FG 116 DA 2.065mm



FG 116/C02V

~~4.305,00€~~ **2.149,00€**

CONFIGURAZIONE COMPOSTA DA:

- FG 116V/68A: Modulo armadietto
- FG 116V/7G: Carrello porta utensili
- FG 116V/68B: Armadietto, porta carta e porta rifiuti

CONFIGURAZIONI FG 116 DA 2.065mm + ARMADIO



FG 116/C03V

~~5.025,00€~~ **2.599,00€**

CONFIGURAZIONE COMPOSTA DA:

- FG 116V/68A: Modulo armadietto
- FG 116V/7G: Carrello porta utensili
- FG 116V/68B: Armadietto, porta carta e porta rifiuti
- FG 118/AR1V: Armadio alto - 500x510x2.000mm

CONFIGURAZIONI FG 116 DA 2.065mm

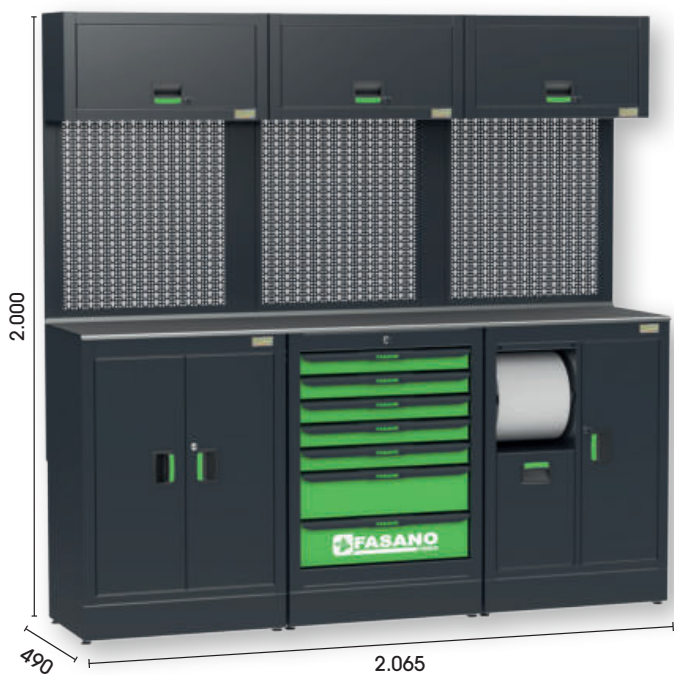

FG 116/C06V

~~4.355,00€~~ **2.199,00€**

CONFIGURAZIONE COMPOSTA DA:

- FG 116V/68A: Modulo armadietto
- FG 116/68V7: Cassettiera fissa a 7 cassetti
- FG 116V/68B: Armadietto, porta carta e porta rifiuti

CONFIGURAZIONI FG 116 DA 1.375mm



FG 116/C015V

~~3.060,00€~~ **1.499,00€**

CONFIGURAZIONE COMPOSTA DA:

- FG 116/68V6: Cassettiera fissa a 6 cassetti
- FG 116V/68B: Armadietto, porta carta e porta rifiuti

CONFIGURAZIONI FG 116 DA 2065mm + ARMADI



FG 116/C04V

~~6.125,00€~~ **3.259,00€**

CONFIGURAZIONE COMPOSTA DA:

- FG 116V/68A: Modulo armadietto
- FG 116V/7G: Carrello porta utensili a 7 cassetti
- FG 116V/68B: Armadietto, porta carta e porta rifiuti
- FG 118/AR1V: Armadio alto - 2000x500x510mm
- FG 118/AR2V: Armadio alto - 2000x1000x510mm

CONFIGURAZIONI FG 116 AD ANGOLO



FG 116/C030V

~~8.070,00€~~ **3.999,00€**

CONFIGURAZIONE COMPOSTA DA:

- FG 116V/68B: Armadietto, porta carta e porta rifiuti
- FG 116V/7G: Carrello porta utensili a 7 cassetti
- FG 116V/68A: Modulo armadietto
- FG 116/68V6: Cassettiera fissa a 6 cassetti
- FG 116V/68A: Modulo armadietto

Il lavoro on the road

Arredamento furgoni!

Ai nostri clienti offriamo il massimo della qualità e dell'efficienza anche su strada.

L'allestimento **Fasano Tools** per furgoni e veicoli commerciali offre la possibilità di creare l'ambiente di lavoro ideale per le proprie esigenze.

Totalmente personalizzabile e modulare, si compone di cassettiere, armadietti, mensole, scaffali e pareti provviste di griglie portautensili, porta minuterie e una vasta gamma di accessori.

Tutto il necessario per lavorare al di fuori della propria officina, seppur portandola sempre con sé.

L'arredo tecnico Fasano Tools dedicato ai veicoli attrezzati si adegua perfettamente ad ogni necessità del lavoro quotidiano. Scegli il colore e la composizione ideale!

MADE IN ITALY

Nuovi moduli in 3 varianti colore

RAL 6018

RAL 5002

RAL 3001



MODULI

ARREDAMENTO FURGONI



MANIGLIE IN ABS CON IMPUGNATURA ERGONOMICA



CASSETTI CON APERTURA COMPLETA PER MODULI PORTA UTENSILI



VALIGIE COMPONENTI CON SCOMPARTI PORTA MINUTERIE



ANTE ESTRAIBILI AD APERTURA TOTALE



VASCHE IN PLASTICA PORTA MINUTERIE



PIANALI ANTISCIVOLO

**LA SOLUZIONE MODULARE PER COMPORRE
L'ARREDAMENTO DEL TUO FURGONE**

in 3 facili STEP



1°

STEP BASE

SELEZIONARE LA **BASE**:

- **APERTA** (SE POSIZIONATA SUL PASSARUOTA) OPPURE **CHIUSA**
- EVENTUALE **RIALZO**

2°

STEP CASSETTI

SELEZIONARE LA **CASSETTIERA**

(LA TIPOLOGIA ED IL NUMERO DELLE CASSETTIERE VARIANO IN FUNZIONE DELLA LARGHEZZA DELLA BASE)

3°

STEP RIPIANI

AGGIUNGERE EVENTUALI **RIPIANI** CON I RELATIVI **MONTANTI LATERALI**
(TENERE PRESENTE LA PROFONDITA' DELLA STRUTTURA E LA SAGOMA DEL FURGONE)



Progettiamo e realizziamo arredi modulari per furgoni attrezzati, in base ad esigenze specifiche e richieste del cliente.

Ogni nostro allestimento furgoni è ideato per ottimizzare gli spazi, creando un ambiente di lavoro efficiente, su misura ed altamente funzionale.

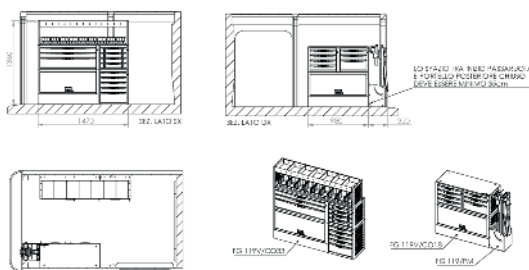



FG 119V/C016

~~2.400,00€~~ **1.199,00€**

**CONFIGURAZIONE ARREDAMENTO
TECNICO PER FURGONI**

Dimensioni: 980x400x1.057mm

Peso: 61,8 Kg



FG 119B/C016



FG 119R/C016



FG 119V/C025

~~2.930,00€~~ **1.499,00€**

**CONFIGURAZIONE ARREDAMENTO
TECNICO PER FURGONI**

Dimensioni: 1.225x400x1.057mm

Peso: 76,2 kg



FG 119B/C025



FG 119R/C025



FG 119V/C012

~~2.920,00€~~ **1.499,00€**

**CONFIGURAZIONE ARREDAMENTO
TECNICO PER FURGONI**

Dimensioni: 980x400x1.592mm

Peso: 74,9 kg



FG 119B/C012



FG 119R/C012



FG 119V/C022 ~~3.470,00€~~ **1.799,00€**

**CONFIGURAZIONE ARREDAMENTO
TECNICO PER FURGONI**

Dimensioni: 1.225x400x1.592mm
Peso: 91,2 kg



FG 119B/C022

FG 119R/C022



FG 119V/C033 ~~4.170,00€~~ **2.199,00€**

**CONFIGURAZIONE ARREDAMENTO
TECNICO PER FURGONI**

Dimensioni: 1.470x400x1.360mm
Peso: 114 kg



FG 119B/C033

FG 119R/C033



FG 119/BL

BANCO DA LAVORO
Dimensioni piani: 810x250mm
Peso: 22,3Kg

~~850,00€~~ **439,00€**



FG 119/PM

**BANCO DA LAVORO DOTATO
DI MORSA 125MM CON
BASE GIREVOLE**

Dimensioni piano: 560x250mm
Peso: 40,5Kg

~~1.250,00€~~ **599,00€**



FG 175/F074

CHIAVE A TAZZA PER FILTRI OLIO FORD 1.0,2.0,2.3 ECOBOOST

~~45,50€~~ **26,90€**



3/8"

FG 175/F074.5

CHIAVE A TAZZA PER FILTRI OLIO FORD 1.5, 1.6 ECOBOOST

~~45,50€~~ **25,90€**



FG 175/F074.5-8

NEW

CHIAVE A TAZZA PER FILTRI OLIO FIAT, LANCIA, ALFA ROMEO

~~50,00€~~ **29,90€**

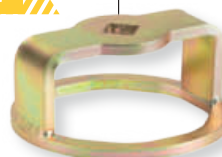

1/2"

FG 175/F014M

CHIAVE A TAZZA PER FILTRI OLIO MOTORI MERCEDES CDI

~~35,50€~~ **19,90€**



1/2"

FG 175/F014T

CHIAVE A TAZZA PER FILTRI OLIO MOTORI TOYOTA

~~30,00€~~ **17,90€**



1/2"

FG 175/OP1

CHIAVE FILTRO OLIO OPEL/VAUXHALL

~~46,50€~~ **27,90€**

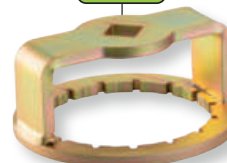

1/2"

FG 175/F084

CHIAVE A TAZZA PER FILTRI OLIO MOTORI MERCEDES

~~57,00€~~ **33,90€**



1/2"

FG 175/HI

CHIAVE A TAZZA PER FILTRI OLIO MOTORE HYUNDAI TUCSON

~~67,00€~~ **39,90€**



1/2"



**CHIAVE AUTOSERRANTE
PER FILTRI OLIO PER SERRAGGI
DESTORSI E SINISTRORSI
- MODELLO PESANTE**

NEW

CODICE	Ø MM	LISTINO	€/PROMO
FG 178/UF110	80 - 110	115,00	69,00
FG 178/UF145	104-145	165,00	99,00

FG 175/S15



**SET 15 CHIAVI
A BUSSOLA MAGNETICHE
PER TAPPI OLIO**

~~135,00€~~ **79,00€**

FG 175/S4



**SET UTENSILI PER
SMONTAGGIO TAPPI
OLIO IN PLASTICA**

~~72,50€~~ **36,90€**

Adatto a:
- VAG TFSI e TDI
- FORD
- BMW
- CITROEN/PEUGEOT

FG 175PF/S4



**SET 4 CHIAVI A TAZZA
PER FILTRI OLIO
- MOD. PURFLUX**

~~74,50€~~ **44,90€**

FG 175/S114



**SET RIPARAZIONE
TAPPI OLIO**

- M13x1.25 - M17x1.5
- M13x1.5 - M20x1.5
- M15x1.5 - M22x1.5

~~265,00€~~ **155,00€**

FG 175/S30



**SET 28 CHIAVI A TAZZA
PER FILTRI OLIO**

~~221,50€~~ **125,00€**



21Pz

FG 203/S20

**KIT PER IL CONTROLLO
TENUTA DELL'IMPIANTO
DI RAFFREDDAMENTO**

~~370,00€~~ **199,00€**



FG 203/BW1
BMW



FG 203/F01
FORD Fiesta dal
2008



FG 203/OP1
OPEL



FG 203/T01
TOYOTA



FG 203/F02
FORD

TAPPI OPTIONAL

CODICE	LISTINO	€/PROMO
FG 203/BW1	36,50	21,90€
FG 203/F01	36,50	21,90€
FG 203/F02	36,50	21,90€
FG 203/OP1	36,50	21,90€
FG 203/T01	36,50	21,90€

FG 203/A

**CHIAVE A BUSSOLA PER SMONTAGGIO
TAPPI RADIATORE**



~~23,00€~~ **13,90€**

FG 202/PV

**POMPA DI PRESSIONE
E DEPRESSIONE**

~~230,00€~~ **135,00€**



FG 203/S7

**STRUMENTO PER IL RIEMPIMENTO A DEPRESSIONE DEI
CIRCUITI DI RAFFREDDAMENTO**

- Utile per effettuare uno spurgo
perfetto grazie alla messa sotto
vuoto del circuito di raffreddamento

~~166,00€~~ **99,00€**



FG 176/S13

**POMPA PER
INSERIMENTO OLIO
CAMBI E DIFFERENZIALI**
Capacità 7,5 litri



~~445,00€~~ **259,00€**

- Fornito di 12 accessori per connessione diretta
- Dotato di valvola di non ritorno



FG 491/200

SIRINGA PER OLIO E FLUIDI
Fornita con 2
guarnizioni di ricambio

~~38,00€~~ **22,90€**

200CC

FG 491/1500

SIRINGA PER OLIO
Fornita con 2
guarnizioni di ricambio

~~85,00€~~ **49,90€**

1.500CC

Non adatta per
carburanti
e olii minerali

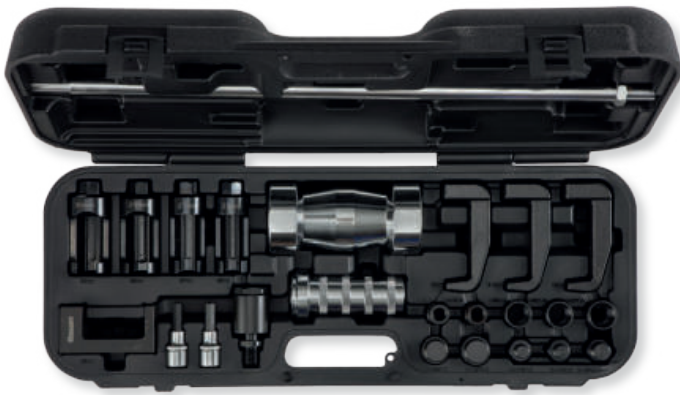

FG 191/S22
~~620,00€~~ **369,00€**
SET UNIVERSALE PER ESTRAZIONE ELETTRO-INIETTORI BOSCH, DELPHI, SIEMENS E DENSO

- Completo di massa battente 4.8KG

CODICE	DESCRIZIONE	APPLICAZIONE
FG 191/ES-1	Adattatore M14X1.5	Delphi
FG 191/ES-2	Adattatore M16X1.5	
FG 191/ES-3	Adattatore M25X0.5	Denso
FG 191/ES-4	Adattatore M25X0.75	Denso
FG 191/ES-5	Adattatore M27X1.0	Bosch
FG 191/ES-6	Adattatore M16X1.0	Denso
FG 191/ES-7	Adattatore M17X1.0	Bosch
FG 191/ES-8	Adattatore M20X1.0	Denso
FG 191/ES-9	Adattatore M25X1.0	Siemens
FG 191/ES-10	Adattatore M27X1.0	Siemens
FG 191/ES-11	Estrattore a forchetta Ø 12 mm	Bosch
FG 191/ES-12	Estrattore a forchetta Ø 13.5 mm	Bosch
FG 191/ES-13	Estrattore a forchetta Ø 16 mm	
FG 191/ES-14	Estrattore a forchetta Ø 26 mm	
FG 191/ES-15	Giunto snodato	
FG 190/A25	Bussola rimozione connessione elettrica 25mm	Siemens
FG 190/A27	Bussola rimozione connessione elettrica 27mm	Siemens
FG 190/A29	Bussola rimozione connessione elettrica 29mm	Bosch
FG 190/A30	Bussola rimozione connessione elettrica 30mm	Bosch
FG 190/EL	Attrezzo rimozione elettrodo ø 7.5mm	
FG 190/EL1	Attrezzo rimozione elettrodo ø 6.9mm	

FG 201/CR
~~250,00€~~ **149,00€**
SET PER VERIFICA ELETTRO-INIETTORI DIESEL COMMON RAIL

Supporto a 6 burette

Adattato per Bosch, Siemens, Denso, e Delphi

FG 190/AD1
ESTRATTORE A FORCHETTA PER INIETTORI PIEZO ELETTRICI
~~52,00€~~ **29,90€**

FG 190/AD2
ESTRATTORE LATERALE PER ELETTRO-INIETTORI BOSCH
~~34,00€~~ **19,90€**

Per le masse battenti da associare ai codici FG 190/AD e FG 190/AD2 consultare il Catalogo generale a pagina 175

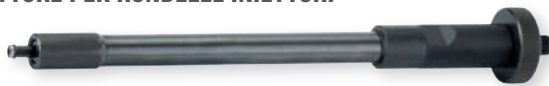
FG 190/RI
ESTRATTORE PER RONDELLE INIETTORI

~~56,00€~~ **33,90€**
FG 190/OP

ESTRATTORE INIETTORI OPEL MOTORI BENZINA AD INIEZIONE DIRETTA
~~45,00€~~ **26,90€**

FG 190/RE
ESTRATTORE INIETTORI DIESEL M9R - RENAULT/OPEL/NISSAN

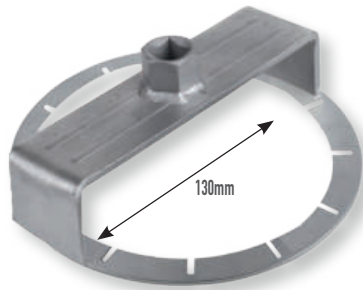
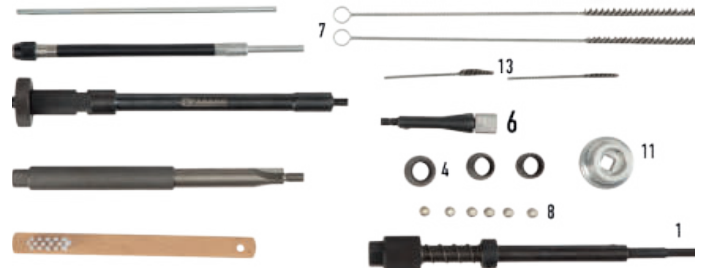
~~235,00€~~ **139,00€**

**FG 174/F2**~~72,50€~~ **43,50€****CHIAVE REGOLABILE PER
GHIERE GALLEGGIANTI
SERBATOIO CARBURANTE
GRUPPO FCA****FG 174/SC**~~118,50€~~ **72,90€****CHIAVE PER
GHIERE GALLEGGIANTI
SERBATOIO CARBURANTE**
Ømm88-170**FG 190/S21**~~350,00€~~ **209,00€****ASSORTIMENTO 21 UTENSILI E ALESATORI
PER PULIZIA SEDI INIETTORI E CANDELETTE**
In valigetta ABS

Codice	Descrizione
FG 190/S21-1	1- Asta porta frese dotato di molla per regolare la profondità
FG 190/S21-4	2- Serie 3 adattatori conici per imbocco sede iniettore (per asta porta frese)
FG 190/S21-5	3- Prolunga flessibile a innesto rapido con attacco quadro femmina 1/4"
FG 190/S21-6	4- Porta spazzole corto con attacco quadro maschio 1/4"
FG 190/S21-7	5- Spazzola lunga per la pulizia della sede iniettore
FG 190/S21-8	6- Set 6 tappi chiusura sede iniettore
FG 190/S21-9	7- Asta per l'inserimento dei tappi chiusura sede iniettore
FG 139/B2.5	8- Chiavino esagonale a L (2.5 mm)
FG 139/B3	9- Chiavino esagonale a L (3 mm)
FG 190/S21-11	10- Mandrino per fresa Ø 19 mm
FG 190/S21-12	11- Spazzola con setole in nylon per pulizia sede iniettore
FG 190/S21-13	12- Spazzola corta per la pulizia della camera iniettore
FG 190/RI	13- Estrattore per rondella di tenuta in rame
FG 190/S21-15	14- Alesatore Ø 15,5 mm

FG 191/S14~~150,00€~~ **89,00€****KIT PER PULIZIA SEDI INIETTORI**
In valigetta ABS

Codice	Descrizione
FG 191/S14-2	1- Asta filettata M5X0.8XL200mm
FG 191/S14-3	2- Tappo chiusura sede iniettore
FG 191/S14-4	3- Spazzola lunga per la pulizia della sede iniettore
FG 191/S14-1	4- Prolunga flessibile
FG 191/S14-6	5- Spazzola a tazza Ø 15
FG 191/S14-7	6- Spazzola a tazza Ø 20
FG 191/S14-8	7- Spazzola Ø 24x85L
FG 191/S14-9	8- Spazzola Ø 18x85L
FG 191/S14-10	9- Spazzola Ø 21x85L

FG 190/S6B

~~165,00€~~ **99,00€**



**SET PER FRESATURA
SEDI INIETTORI**

Codice	Descrizione
FG 190/S6-1	1- Fresa piana 17x17mm
FG 190/S6-2	2- Fresa piana 15x19mm
FG 190/S6-3	3- Fresa piana 17x19mm
FG 190/S6-4	4- Fresa conica 17x21mm
FG 190/S6-5	5- Fresa conica 17x17mm



FG 182/S16

~~500,00€~~ **299,00€**

**SET ESTRAZIONE CANDELETTE SPEZZATE
M8, M10, MULTIJET**



Codice	Descrizione
FG 72/GMC3	1- Giramaschi a cricchetto reversibile - mod. lungo
FG 182/S16-ES	2- Estrattore
FG 182/S16-PR	3- Prolunga doppia punta
FG 182/S16-PU10	4- Punta 7x4.2mm per FIAT Multijet
FG 182/S16-PR2	5- Prolunga per punta FIAT Multijet per 7x4.2mm
FG 139/3	6- Chiavino esagonale ad L 3 mm
FG 182/S16-GU	7- Guida per forare 6mm
FG 75/HSS3,5	8- Punta per forare 3.5 mm (2pz)
FG 182/S4-5	9- Inserto filettato M5
FG 182S16/S4-4	10- Prolunga + maschio M5X0.8 (FIAT Multijet)
FG 182S16/S4-3	11- Prolunga + maschio M8x1 (FIAT Multijet)
FG 182/S16-PU7	12- Punta per forare - 7x5.5mm
FG 182/S16-PU9	13- Punta per forare - 9x5.5mm
FG 72/GMC2	14- Giramaschi a cricchetto reversibile - mod. corto
FG 182/S4-1	15- Estrattore
FG 182/S16-IF14	16- Inserto filettato 1/4" (2pz)
FG 624L/TX10	17- Chiave a bussola Torx E10
FG 72/M8X1	18- Serie 2 maschi a mano in acciaio HSS
FG 72/M10x1	19- Serie 2 maschi a mano in acciaio HSS
FG 182/S16-MA14	20- Maschio 1/4"

FG 189/S13

~~230,00€~~ **139,00€**

SET CONTROLLO PRESSIONE SISTEMI TURBO

Permette di verificare la tenuta dell'impianto di alimentazione dal collettore di spirazione fino alla chiocciola del compressore



FG 179/S16



**SET UTENSILI
PER PULEGGE
LIBERE ALTERNATORI**

~~160,00€~~ **89,00€**



FG 180/S38

~~700,00€~~ **399,00€**



**SET UTENSILI
PER CENTRAGGIO
FRIZIONI SAC**

FG 180/S17

~~590,00€~~ **199,00€**



**SET UTENSILI
PER DIAGNOSI
DOPPIE FRIZIONI DMF**

FG 178/SF

~~1.820,00€~~ **899,00€**



APPARECCHIO SPURGO LIQUIDO FRENI

- alimentazione 12V con cavi batteria
- dotato di vano posteriore porta oggetti e contenitore di recupero olio
- 2 tappi universali in dotazione

TAPPI IN DOTAZIONE



42mm

44,45,46mm

**PRESSIONE REGOLABILE
FINO A 2 BAR**

**CAPACITÀ
SERBATOIO 5L**

**SCocca IN
ACCIAIO INOX**

**DOTATO DI SENSORE
FINE LIQUIDO**

TAPPI SPECIFICI PER MOTORI FORD (NON IN DOTAZIONE DI BASE)



FG 178SF/AD13

Fiesta 2011-2016

~~60,00€~~ **35,90€**



FG 178SF/AD14

Mondeo dal 2014
Fiesta dal 2016
Mazda CX3/CX5

~~60,00€~~ **35,90€**

FG 178/S6

**KIT TAPPI
PER VEICOLI ASIATICI**

- TOYOTA - MAZDA
- HYUNDAI - SUBARU
- NISSAN - HONDA
- MITSUBISHI - SUZUKI

~~330,00€~~ **179,00€**



FG 198/S11

KIT SMONTAGGIO BULLONI PINZE FRENO
BMW, Ford, VAG, Mercedes



~~138,00€~~ **79,90€**

FG 198/B7

**CHIAVE A BUSSOLA PER
BULLONI PINZE FRENO - 14MM**



~~17,50€~~ **9,90€**

FG 198/B9

**CHIAVE A BUSSOLA PER
BULLONI PINZE FRENO - 9MM**



~~17,50€~~ **9,90€**

FG 199/PF



SET ARRETRATORE PNEUMATICO PER PISTONCINI FRENI A DISCO

Per destrorsi e sinistrorsi



~~225,00€~~ **135,00€**

CHIAVE A BUSSOLA RINFORZATA PER DADI BULLONI RUOTA
Attacco quadro interno: 1/2"



CODICE	MM	APPLICAZIONE	LISTINO	€/PROMO
FG 628/R17.5	16.5X17.5	FIAT, JEEP	20,00	11,90€
FG 628/R18.5	18.5X19.5	FORD	20,00	11,90€
FG 628/R21.5	21X21.5	FORD GALAXY, VOLVO, TOYOTA	22,00	11,90€
FG 628/R22.5	22X22.5	CHRYSLER DODGE, LAND ROVER, RANGE ROVER	22,00	11,90€
FG 628/R27.5	27X27.5	LAND ROVER DISCOVERY, RANGE ROVER	25,00	11,90€

1/2"

FG 627/S3

CHIAVI A BUSSOLA PER CERCHI IN LEGA LEGGERA

17, 19, 21mm

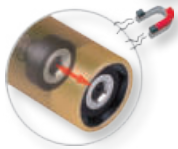

DOTATE DI ANELLO MAGNETICO DI TENUTA

~~85,00€~~ **44,90€**

FG 628/S7

~~115,00€~~ **69,00€**

CHIAVI A BUSSOLA RINFORZATE PER CERCHI IN LEGA LEGGERA CON ADATTATORI PER BULLONI DANNEGGIATI

17, 19, 21mm



1/2"

KIT PER RIMOZIONE DADI ANTIFURTO

FG 164/S3

~~250,00€~~ **145,00€**

KIT RIMOZIONE DADI ANTI FURTO CON COLLARE - BMW

Completo di massa battente e box in ABS

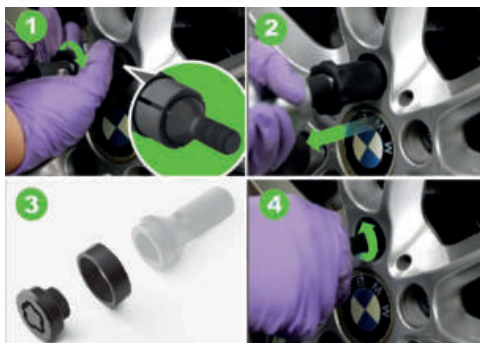

FG 164/S10

SET CHIAVI A BUSSOLA PER RIMOZIONE DADI RUOTA ANTIFURTO UNIVERSALE

Non utilizzare con avvitatori a percussione



~~180,50€~~ **109,00€**



FG 168/GA

~~60,00€~~ 36,00€



UTENSILE DIVARICATORE UNIVERSALE

Elevata capacità
Utilizzo universale
Superfici di pressione parallele
Capacità 5-11,5mm

NEW

FG 168/S7

~~250,00€~~ 149,00€

ESTRATTORE A C PER BOCCOLE E CUSCINETTI

Struttura robusta con telaio in acciaio
Con adattatori per attacco da 1/4", 3/8", 1/2", 3/4" per l'utilizzo su automobili, furgoni e veicoli commerciali
Vite mm 165 - H/mm 89

NEW

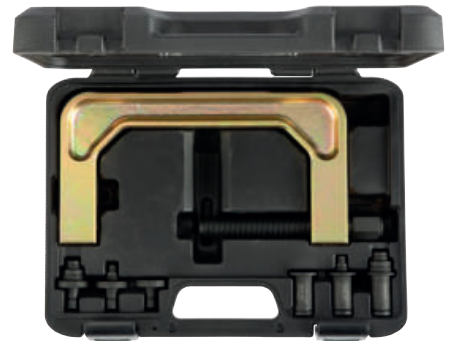

FG 165/S26

~~700,00€~~ 429,00€

SET UTENSILI SPECIALI PER SMONTAGGIO E MONTAGGIO SILENT BLOCK

Boccole per Ø 44-82mm
4 barre filettate M10, M12, M14, M16



FG 165/S7

~~195,00€~~ 119,00€

SET MONTAGGIO/SMONTAGGIO SILENT BLOCK FIAT PANDA 4X4 E PANDA METANO



FG 165/G01

~~180,00€~~ 99,00€

ESTRATTORE PER GIUNTI OMOCINETICI

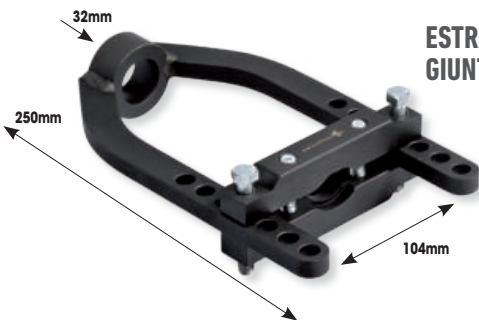

FG 166/S28

KIT PER SMONTAGGIO E MONTAGGIO CUSCINETTI RUOTA

- smontaggio Ø 34-45mm
- montaggio Ø 60-84mm

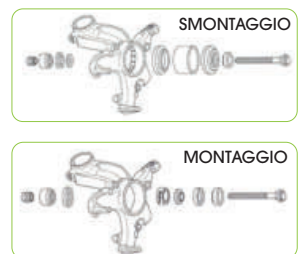

FG 165/G02

UTENSILE PER SMONTAGGIO GIUNTI OMOCINETICI



~~150,00€~~ 89,00€

~~475,00€~~ 279,00€



FG 166/LT

**AVVITATORE AD IMPULSI 18V
(KIT CON 1 BATTERIA)**

~~750,00€~~ **399,00€**

BRUSHLESS MOTOR

18v - 5.0A

Coppia massima



2.900



Scocca anteriore in acciaio resistente agli urti



Led di puntamento

Impugnatura Bi-material per un maggior grip

Aggancio rinforzato

Sistema di sgancio rapido



Batteria al Litio 5.0 Ampere e 18 Volt



FG 166/LT2

**AVVITATORE AD IMPULSI 18V
(KIT CON 2 BATTERIE)**

~~920,00€~~ **459,00€**

FG 98/A1

CARICABATTERIE E MANTENITORE DI CARICA 6/12V

- Corrente di carica 1A
- Capacità di carica 8Ah - 30Ah
- Utilizzabile con tutti i tipi di batterie, sia al piombo acido (WET, GEL, AGM, MF, EFB) che al litio
- Indicatore del livello di carica

NEW



~~65,00€~~ **39,00€**

FG 98/A6

CARICABATTERIE E MANTENITORE DI CARICA 6/12V

- Corrente di carica 6A
- Capacità di carica 8Ah - 100Ah
- Utilizzabile con tutti i tipi di batterie, sia al piombo acido (WET, GEL, AGM, MF, EFB) che al litio
- Display LCD
- 8 modalita' di ricarica
- Indicatore del livello di carica
- Identificazione delle batterie esauste

WINTER M O D E

CICLO DI RICARICA A BASSE TEMPERATURE

NEW



~~120,00€~~ **69,00€**

FG 98/A15

CARICABATTERIE E MANTENITORE DI CARICA 6/12/24V

- Corrente di carica massima 15 A (6V e 12V) - 8 A (24V)
- Capacità di carica 150Ah
- Utilizzabile con tutti i tipi di batterie, sia al piombo acido (WET, GEL, AGM, MF, EFB) che al litio
- 8 modalita' di ricarica
- Indicatore del livello di carica
- Identificazione delle batterie esauste

WINTER M O D E

CICLO DI RICARICA A BASSE TEMPERATURE

NEW



~~280,00€~~ **169,00€**

JUMP M O D E

FUNZIONE RICARICA PER BATTERIE MOLTO SCARICHE

FG 97/LT

AVVIATORE PORTATILE MULTIFUNZIONE

- Adatto per l'avviamento di emergenza di motori con batteria da 12V
- Display LCD - 2 uscite USB 5V 2.4A
- Cavo 12V 10A per presa accendisigari in dotazione
- Led con 5 modalita'
- 3 modalita' di ricarica (in dotazione: caricabatterie, cavo USB tipo C, adattatore 14V 1A per presa accendisigari)
- Funzione Power Bank - Funzione Travel Lock
- In dotazione boost con morsetti per avviamento motore, custodia

~~250,00€~~ **149,00€**



NEW



FG 172/FA2

NEW

PINZA A CRICCHETTO PER FASCETTE MANICOTTI

Funzione bloccaggio morsetti a cricchetto
Apertura con meccanismo a molla



~~98,00€~~ 59,90€

FG 172/MA

NEW

PINZA PER FASCETTE A SCATTO CLIC

Con ganasce multipresa regolabili



~~98,00€~~ 59,90€

FG 172/FA

PINZA PER FASCETTE A SCATTO CLIC



~~72,50€~~ 39,90€

FG 172/PA

PINZA PER SERRAGGIO E TAGLIO FASCETTE A NASTRO IN ACCIAIO INOX

Ø/MM 4.7 - 9.5

INDICATA ANCHE PER FASCETTE PANDUIT



~~67,00€~~ 39,90€

FG 172/AS2



PINZA PER ANELLI STRINGITUBO CON PROLUNGA INTERCAMBIABILE
Apertura: 3-52mm

~~108,00€~~ 65,00€

FG 172/G02

PINZA PER COLLARI OETIKER



~~105,00€~~ 62,90€

FG 184/S5



SET 5 CHIAVI PER DADI TENDICINGHIA

13, 15, 16, 17, 19mm

~~155,00€~~ **92,00€**

FG 184/S6

~~95,00€~~ **39,00€**

SET CHIAVE TENDICINGHIA CON INSERTI MASCHIO



CONTENUTO:

- TX40, TX45, TX60 - H8, H10

FG 184/FT1

~~70,00€~~ **39,00€**

CHIAVI PER DADI TENDICINGHIA FIAT, FORD, CITROEN, PEUGEOT



FG 181/PM2

ESTRATTORE UNIVERSALE
PER PULEGGE



~~93,00€~~ **55,00€**

FG 172/TG

PINZA RIMOZIONE TUBI
ACQUA E CARBURANTE



~~49,50€~~ **21,90€**

FG 172/MJ

PINZA RACCORDI
RAPIDI TUBO CARBURANTE

Per Multijet



~~26,00€~~ **15,90€**

FG 172/S4

KIT UTENSILI PER SGANCIO
RACCORDI FILTRI GASOLIO



~~50,00€~~ **19,90€**

FG 171/N

PINZA PER RACCORDI
RAPIDI TUBO CARBURANTE



~~30,00€~~ **17,90€**

FG 171/FL

PINZA PER RACCORDI
RAPIDI TUBO CARBURANTE
CON TESTA FLESSIBILE



~~51,50€~~ **29,90€**



FG 215/S40

1.550,00€ **849,00€**



TESTER PROVA COMPRESIONE DIGITALE, COMPLETO DI FINTI NIETTORI E FINTE CANDELETTE PER SISTEMI DIESEL

MADE IN ITALY



ACCESSORI DI BASE IN DOTAZIONE



PROVA ALTERNATORE
PROVA TENSIONE BATTERIA



PROVA COMPRESIONE

MADE IN ITALY



FG 219/S

3.350,00€ **1.999,00€**



TESTER MULTI-FUNZIONE PER PROVA COMPRESIONE E PROVA PRESSIONE CARBURANTI

CARATTERISTICHE TECNICHE:

- grado di precisione: 1%FS
- software in 8 lingue (IT, EN, DE, FR, ES, PT, GR, PL)
- display touch screen LCD retroilluminato a colori, 4.3"
- 2 sensori (0-80Bar e 0.2500Bar)



PROVA ALTERNATORE
PROVA TENSIONE BATTERIA



PROVA COMPRESIONE



PROVA PRESSIONE CARBURANTE
(ALTA E BASSA)



PROVA OLIO MOTORE



CE

FG 220/BT

TESTER DIGITALE PER BATTERIE 12V E 24V

CARATTERISTICHE TECNICHE:

Dimensioni: 90X50X235 mm
Tensione di funzionamento: da 9V a 35V DC
Tempo di verifica della batteria: circa 1 minuto
Batteria interna per memoria data/ora: CR1220 (1 pezzo)

~~420,00€~~ **249,00€**



CARATTERISTICHE:	DISPLAY RETROILLUMINATO
	SOFTWARE 6 LINGUE: italiano; inglese; spagnolo; polacco; tedesco; francese
	STAMPANTE INTEGRATA CON ROTOLO DI CARTA TERMICA
	SISTEMA RILEVAZIONE FALSO CONTATTO COLLEGAMENTO PINZE
APPLICAZIONI:	TEST BATTERIE 12 E 24V
	TEST ALTERNATORE (INTELLIGENTE E NORMALE) 12-24V CARICA
	TEST SISTEMA DI AVVIAMENTO
BATTERIE SUPPORTATE:	PB, WET, GEL AGM, AGM FLAT, EFB
APPLICAZIONI:	CCA: 100-1700; IEC: 100-1000; EN: 100-1700; DIN: 100-1000; JIS
LUNGHEZZA DEI CAVI:	570 mm

FG 193DSG/S9

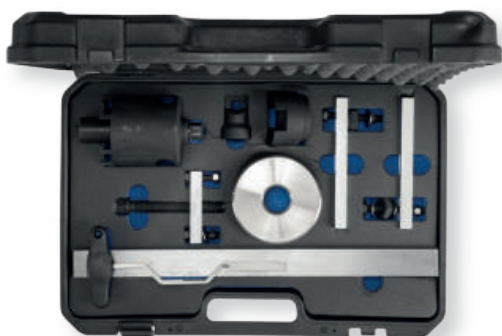

SET MONTAGGIO, SMONTAGGIO E REGISTRAZIONE FRIZIONI DSG 7 RAPPORTI

~~1050,00€~~ **599,00€**

FG 193/DCT



UTENSILE INSERIMENTO E RIMOZIONE GRUPPO FRIZIONE DCT

~~160,00€~~ **95,00€**

FG 193/ATJ



UTENSILE SMONTAGGIO TAPPO OLIO CAMBIO JAGUAR/LAND ROVER



~~45,00€~~ **26,90€**

FG 194/TS



LEVA PER BLOCCAGGIO SBLOCCAGGIO GRUPPO MECCATRONICO FRIZIONE CAMBIO AUTOMATICO DSG

~~32,00€~~ **19,00€**

FG 193/MB



UTENSILE PER SCARICO E MISURAZIONE OLIO CAMBIO MERCEDES 9G TRONIC

~~65,00€~~ **39,00€**



Gli strumenti migliori, per veri professionisti

La gamma prodotti Fasano Tools dedicata al settore Carrozzeria comprende tutto il necessario per un lavoro altamente professionale.

Utensili performanti e caratterizzati da dettagli votati all'efficienza. Il nostro vasto e completo assortimento di utensili per carrozzeria è dedicato a lavori di precisione e comprende kit di punzoni, set di raschietti, leve, coltelli, guidafile, impugnature, cunei, levapioli, pinze, leverini, levamolle, ventose, utensili dedicati alla rimozione di schegge ed ogni strumento essenziale per i professionisti del settore.

Scopri tutti
nella sezione
AUTOMOTIVE



VENTOLA DOTATA
DI IMPUGNATURA
E SISTEMA
POMPANTE

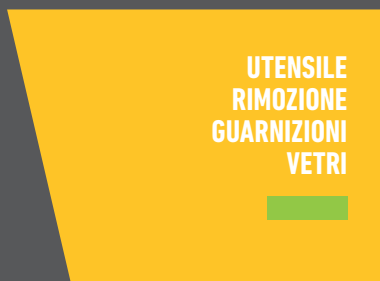

UTENSILE
RIMOZIONE
GUARNIZIONI
VETRI



UTENSILE
RIMOZIONE
SCHEGGE



KIT 4
MINI-VENTOSE
PER CRISTALLI
AUTO



RASCHIETTO
MANUALE
A LAMA
DRITTA



KIT 6
VENTOSE
SINGOLE



FG 130AL/S5



KIT PUNZONI IN PLASTICA E BULINO IN ALLUMINIO

Contenuto:

1 bulino in alluminio regolabile 70mm-100mm

Filettatura M8x1.25

4 punzoni in gomma dura resistente agli urti e anti graffio

~~36,50€~~ **21,90€**

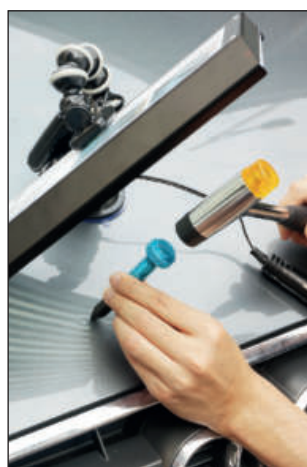

FG 186/S11

SET 11 UTENSILI IN NYLON PER CARROZZERIA



~~118,50€~~ **65,00€**

FG 184P/S3

~~26,00€~~ **14,90€**



SET 3 CUNEI IN PLASTICA

Materiale: Polipropilene ad alta resistenza

FG 184R/S3

~~46,50€~~ **27,90€**



SET 3 RASCHIETTI IN ACCIAIO CON MANICO IN ABS

Lunghezza totale: 280mm

FG 184/R1

~~21,00€~~ **12,50€**



RASCHIETTO IN ACCIAIO CON MANICO IN ABS

Lunghezza totale: 280mm

FG 184/R2

~~23,00€~~ **13,90€**



RASCHIETTO IN ACCIAIO CON PROTEZIONE IN PVC E MANICO IN ABS

Lunghezza totale: 275mm

FG 188P/S2

~~41,50€~~ **24,90€**



KIT CUNEI PER RIMOZIONE MODANATURE IN PLASTICA

Materiale: Polipropilene ad alta resistenza

1pz dotato di manico resistente alle percussioni

1pz senza manico per ideale per spazi ristretti



FG 188/P1



LEVA PER PARTI IN PLASTICA

MATERIALE: Nylon e fibra di vetro
Elevata resistenza alla torsione
Dotate di foro per appendimento



~~19,00€~~ **11,50€**

FG 185P/S4



KIT 4 LEVE PER PARTI IN PLASTICA

MATERIALE: Nylon e fibra di vetro
Elevata resistenza alla torsione
Dotate di foro per appendimento

~~26,00€~~ **15,90€**

FG 186/S3

SET 3 LEVERINI IN MATERIALE PLASTICO

~~10,00€~~ **5,90€**

FG 186/S3B

SET 3 UNCINI IN MATERIALE PLASTICO

~~12,00€~~ **6,90€**

FG 186P/S5



SET 5 LEVE IN NYLON RIMOZIONE PIOLI

~~37,50€~~ **19,90€**

FG 185/S5

~~98,00€~~ **59,00€**

SET 5 LEVAPIOLI CON MANICO IN ABS

Contenuto: FG 185/A1, FG 185/A2, FG 185/A6, FG 185/A7, FG 185/A8



FG 186/AL1

NEW



LEVA EXTRA PIATTA IN METALLO

Design unico della lama con un lato curvo ed uno dritto per la rimozione di elementi di fissaggio interni ed esterni anche negli spazi più stretti
Punta sottile ad alta resistenza

~~25,00€~~ **14,90€**



FG 185B/S2

SET 2 LEVAPIOLI CON MANICO IN ABS

~~41,50€~~ **24,90€**



FG 186/S5

SET 5 LEVE CON LAMA IN ACCIAIO INOX

~~98,00€~~ **57,90€**



FG 186/S4

NEW

SET 4 UNCINI CON LAMA IN ACCIAIO
Con impugnatura bimatériale



~~25,00€~~ **14,90€**

FG 185/RM



**UTENSILE PER RIMOZIONE MANIGLIA
POGGIA MANO - GRUPPO VAG**

Lunghezza totale: 255mm
Impugnatura in ABS



~~31,00€~~ **18,90€**

FG 185/CR



UTENSILE LEVA MOLLE A "C"

Ideale per la rimozione delle molle a C presenti sulle manovelle alzavetro

~~10,50€~~ **5,90€**



FG 189/P01



UTENSILE RIMOZIONE CILINDRETTO CHIUSURA PORTIERE - GRUPPO VAG

~~21,00€~~ **12,90€**

FG 189/P02



UTENSILE RIMOZIONE CILINDRETTO CHIUSURA PORTIERE - GRUPPO VAG

NEW

~~40,00€~~ **23,90€**

FG 183/RV1

~~21,00€~~ **12,90€**



UTENSILE RIMOZIONE GUARNIZIONI VETRI

Lunghezza totale: 252mm
Impugnatura in ABS



UTENSILE RIMOZIONE SCHEGGE



L/mm

Ideale per la pulizia del canale alzavetro
Punta sferica per evitare danneggiamenti delle guide portiera

CODICE	L/mm	LISTINO	€/PROMO
FG 182/RG10	255mm	19,00	11,50
FG 182/RG24	320mm	26,00	15,50



FG 183/CM

COLTELLO MANUALE DOTATO DI CAVO E SISTEMA FERMA CAVO

Impugnatura e cavo rivestito in PVC
Fornito con una lama da 25mm già montata



~~51,50€~~ **29,90€**

FG 183/RA1

RASCHIETTO MANUALE A LAMA DRITTA



-Fornito con una lama in dotazione
-Impugnatura in ABS dotata di foro per appendamento
-Dotato di protezione lama in ABS

~~26,00€~~ **15,90€**



COLTELLO MANUALE DOTATO DI LAMA INTERCAMBIABILE



Fornito con una lama in dotazione
Impugnatura con rivestimento in PVC
Sistema di bloccaggio lama a vite

CODICE	L/mm	LISTINO	€/PROMO
FG 183/CK250	250mm	22,00	12,90
FG 183/CK450	450mm	33,00	19,90
FG 183/CK600	600mm	41,50	24,90

FG 187/GR

~~29,00€~~ **16,90€**

UTENSILE UNIVERSALE PER FISSAGGIO GUARNIZIONI



Dotato di 6 accessori
Sistema guida a rullo
Impugnatura in ABS

FG 187/GU

LEVA BLOCCAFILO



~~29,00€~~ **16,90€**

FG 187/IM



SET 2 IMPUGNATURE PER CAVO D'ACCIAIO

~~41,50€~~ **24,90€**

FG 187/GU2

GUIDAFILO A T CON IMPUGNATURA IN ABS



~~26,00€~~ **15,90€**

lunghezza
50 m

FG 187/W50

BOBINA DI FILO IN ACCIAIO PER TAGLIO SIGILLANTE - sezione quadrata



~~35,50€~~ **19,90€**

FG 187/WT22.5

lunghezza
22,5 m

BOBINA DI FILO IN ACCIAIO PER TAGLIO SIGILLANTE - sezione triangolare



~~26,00€~~ **15,90€**

FG 187/NY

lunghezza
50 m

BOBINA DI FILO IN NYLON - sezione intrecciata



~~62,00€~~ **36,90€**

FG 187/IW50

lunghezza
50 m

BOBINA DI FILO IN ACCIAIO PER TAGLIO SIGILLANTE - sezione intrecciata



~~31,00€~~ **18,90€**

FG 187/S2

~~700,00€~~ **419,00€**

SET PER SMONTAGGIO PARABREZZA CON SISTEMA VENTOSE A CRICCHETTO In valigetta di ABS



NEW

FG 188P/S4

~~65,00€~~ **39,90€**

SET PROTEZIONE CRUSCOTTO CON MANIGLIA



NEW

FG 187/K10

~~24,00€~~ **14,50€**

KIT 4 MINI-VENTOSE PER CRISTALLI AUTO - capacità 10Kg



FG 187/S7

~~216,50€~~ **125,00€**

SET 7 UTENSILI PER CRISTALLI AUTO



FG 187/K130

VENTOSA SINGOLA MULTIFUNZIONE

- capacità: 130Kg
- diametro: 254mm
- adatta per parabrezza autobus e mezzi pesanti
- fornita in box di ABS

~~288,50€~~ **169,00€**



FG 187/K40

VENTOSA SINGOLA DOTATA DI IMPUGNATURA E SISTEMA POMPANTE

- capacità: 40 kg
- diametro: 178mm - 7"

~~196,00€~~ **109,00€**



FG 187/K/S6

~~57,00€~~ **33,90€**

KIT 6 VENTOSE SINGOLE

- capacità: 10 Kg - diametro: 78mm - 3"

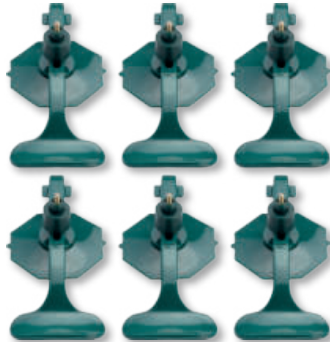

FG 165/BC3

~~65,00€~~ **39,00€**

ESTRATTORE REGOLABILE PER BRACCI TERGICRISTALLO BMW
Ø/mm max: 37,5 - L/mm: 64

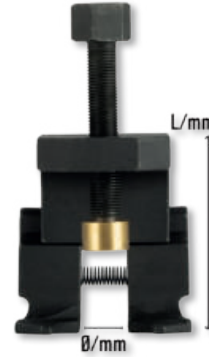

NEW

FG 187/PN

~~263,00€~~ **159,00€**



TIRABOLLI PNEUMATICO, COMPLETO DI 3 VENTOSE



FG 165BC/S6

~~230,00€~~ **139,00€**



SET 6 ESTRATTORI PER BRACCI TERGICRISTALLO

- 1: VW, Porsche;
- 2: Ford, Seat, Mercedes;
- 3: BMW, VW;
- 4: Audi A3-A4-A5-A6;
- 5: VW, Opel, Honda;
- 6: Audi Q7

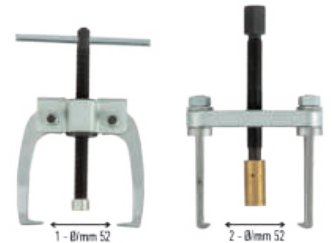

NEW



COLONNETTE DI SOSTEGNO



CE

CODICE	CAPACITA'	H - MIN/MAX	€/PZ	€/PROMO
FG 725/3T	3 TON	285-425MM	95,00	49,00
FG 725/6T	6 TON	390-605MM	160,00	85,00
FG 725/12T	12 TON	495-720MM	280,00	149,00

FG 750/A

CARRELLO MOVIMENTAZIONE VEICOLI

- Capacità 680Kg
- Sistema di sollevamento a pedale
- Dotato di 4 ruote girevoli

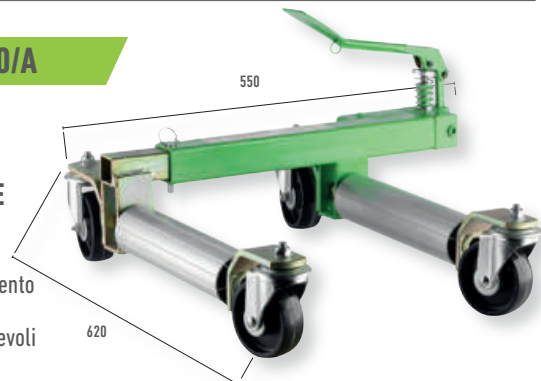

~~420,00€~~ **224,00€**

CE

SOLLEVATORI IDRAULICI A BOTTIGLIA



CE

CODICE	CAPACITA'	H - MIN/MAX	STELO	€/PZ	€/PROMO
FG 735/4T	4 TON	193-373MM	60MM	85,00	45,00
FG 735/6T	6 TON	214-416MM	70MM	98,00	52,00
FG 735/10T	10 TON	230-460MM	80MM	140,00	74,00
FG 735/16T	16 TON	230-440MM	60MM	160,00	85,00
FG 735/20T	20 TON	242-452MM	60MM	200,00	105,00

FG 748/0.5T

SUPPORTO SOSTEGNO MOTORE

- Capacità 500Kg



~~250,00€~~ **129,00€**

GUARDA IL VIDEO



MADE IN ITALY



SICUREZZA TOTALE
Display digitale in grado di misurare la forza di compressione applicata



AFFIDABILITA'
Le griffe sono dotate di un incavo profondo per garantire una presa totale della molla senza rischi di alcun genere per l'utilizzatore



VELOCITA' D'USO
Lo speciale sistema autocentrante permette di posizionare i bracci con una sola mano e in modo rapido



E' SICURO
E' dotato di base di appoggio inferiore per evitare cadute accidentali dell'ammortizzatore in fase di lavoro



FG 750/1P

SMONTA AMMORTIZZATORI DOTATO DI 1 PISTONE

Potenza spinta:
1.2 ton (10 bar)
- 0.9 ton (8 bar)
Corsa di compressione molla: 300mm

~~2.600,00€~~ **1.389,00€**



FG 750/2P

SMONTA AMMORTIZZATORI DOTATO DI 2 PISTONI

Potenza spinta:
2.4 ton (10 bar)
- 1.9 ton (8 bar)
Corsa di compressione molla: 300mm

~~3.300,00€~~ **1.699,00€**



FG 752/1P

SMONTA AMMORTIZZATORI DOTATO DI 1 PISTONE E DISPLAY DIGITALE

Il display digitale visualizza la pressione applicata durante la fase di utilizzo

~~3.400,00€~~ **1.699,00€**



FG 752/2P

SMONTA AMMORTIZZATORI DOTATO DI 2 PISTONI E DISPLAY DIGITALE

Il display digitale visualizza la pressione applicata durante la fase di utilizzo

~~4.100,00€~~ **1.999,00€**



FG 213/LT

LEVA PER ESTRAZIONE TESTINE BRACCIO
OSCILLANTE E AMMORTIZZATORI



~~310,00€~~ **165,00€**

FG 213/SM

TRAVERSA SOSTEGNO
MOTORE INFERIORE



~~750,00€~~ **399,00€**

FG 740/0.5T

~~600,00€~~ **319,00€**

SOLLEVATORE IDRAULICO DA FOSSA E SOTTOPONTE
- CAPACITÀ 500KG

- Sistema di sollevamento a pedale
- Dotato di 4 ruote girevoli

CE



CE

FG 738/1T

~~1.100,00€~~ **579,00€**

GRU IDRAULICA PIEGHEVOLE
CON POMPA A DOPPIO EFFETTO

- Capacità: 1 Ton
- Versione richiudibile
- Dotata di pompa a doppio effetto
- Ruote in acciaio per una maggiore durata e portata

FG 745/CMR

CAVALLETTO SOSTEGNO MOTORE RICHIUDIBILE

- Versione richiudibile
- Possibilità di rotazione a 360°
- Ruote in acciaio per una maggiore durata e portata

~~950,00€~~ **499,00€**



Sistema di rotazione a 360° a manovella



FG 745/CMF

CAVALLETTO SOSTEGNO MOTORE

- Possibilità di rotazione a 360°
- Ruote in acciaio per una maggiore durata e portata

~~460,00€~~ **245,00€**



Sistema di rotazione a 360°



FG 710/C

SEGGIOLINO GIREVOLE, DOTATO DI ACCESSORI

~~150,00€~~ **79,00€**



FG 710/D

SEGGIOLINO GIREVOLE, DOTATO DI ACCESSORI

~~245,00€~~ **129,00€**



FG 710/E

NEW



LETTINO SOTTO MACCHINA IN PLASTICA ANTI-URTO

Dimensioni: 1.000x470x130mm
6 ruote girevoli

~~150,00€~~ **75,00€**

FG 712/A

PORTA MINUTERIE/UTENSILI DOTATO DI RUOTE GIREVOLI

- Dotato di 2 scomparti magnetici porta minuterie
- Dotato di 2 ampi scomparti porta utensili
- Dotato di piastra centrale magnetica
- 3 ruote girevoli da 500mm
- Materiale: ABS resistente agli urti



~~50,00€~~ **19,90€**

FG 718/3.5T

SOLLEVATORE IDRAULICO 3.5T MODELLO CORTO E RIBASSATO

CARATTERISTICHE TECNICHE:

- Design ribassato, ideale per lavorare su veicoli con bassa altezza da terra
- Portata elevata per utilizzo anche su fuoristrada e furgoni
- Robusta struttura in metallo
- Velocità di discesa controllata
- Manico con gomma antiurto
- 4 ruote in nylon
- Valvola di spurgo dell'aria
- Altezza minima 95 mm – altezza massima 540 mm
- Peso 39 kg

~~560,00€~~ **298,00€**



DIMENSIONI

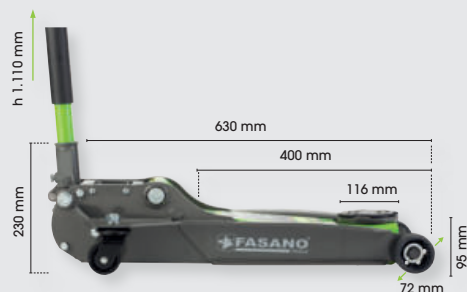

FG 718/2.5T

SOLLEVATORE IDRAULICO 2.5T MODELLO CORTO

CARATTERISTICHE TECNICHE:

- Robusta struttura in metallo
- Velocità di discesa controllata
- Manico con gomma antiurto
- 4 ruote in nylon
- Valvola di spurgo dell'aria
- Altezza minima 75 mm – altezza massima 510 mm
- Peso 30 kg

~~470,00€~~ **249,00€**

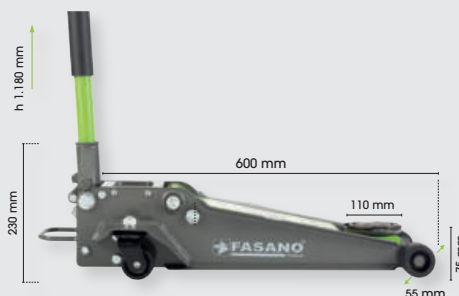

DIMENSIONI

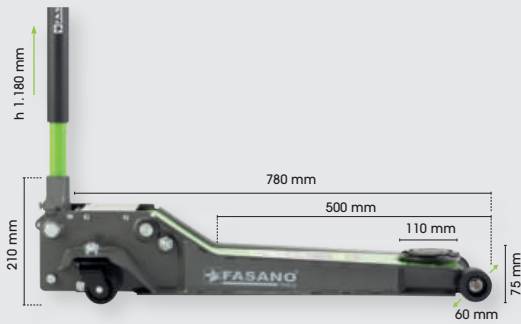

FG 719/2T

**SOLLEVATORE IDRAULICO 2T
MODELLO LUNGO E RIBASSATO**

CARATTERISTICHE TECNICHE:

- Design ribassato, ideale per lavorare anche su veicoli con bassa altezza da terra
- Versione lunga
- Robusta struttura in metallo
- Velocità di discesa controllata
- Manico con gomma antiurto
- 4 ruote in nylon
- Valvola di spurgo dell'aria
- Altezza minima 75 mm - altezza massima 610 mm
- Peso 43,5 kg

~~740,00€~~ **369,00€**



CE

FG 722/5T

**SOLLEVATORE IDRAULICO A CARRELLO 5 TON
- MODELLO LUNGO PER MEZZI PESANTI**

~~1.420,00€~~ **755,00€**

Sistema di sollevamento ausiliario a pedale



Ruote in acciaio montate su cuscinetti a sfera

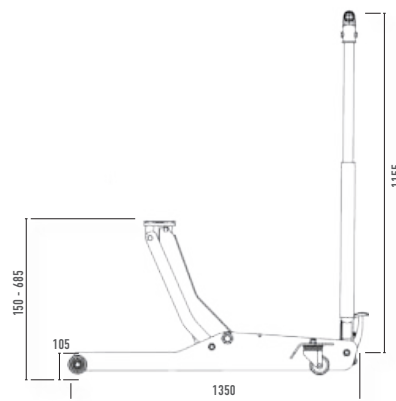

**SELF-RETURN
INTEGRATO**



CE

INSIEME CORRIAMO PIU' VELOCI!



ED
MOTORSPORT

Durante le stagioni sportive 2022 e 2023, Fasano Tools ha affidato il ruolo di Brand Ambassador al giovane Sport Driver Eliseo Donno. L'elegantissima Ferrari 488 Evo ha portato, con onore, sui circuiti Internazionali più prestigiosi, il marchio Fasano Tools, Main Sponsor, simbolo di una partnership basata sulla reciproca fiducia e stima. Nel 2023 Eliseo Donno è diventato Campione Europeo nel Campionato "Ferrari Challenge - Trofeo Pirelli" e ha conquistato il secondo posto sia nella competizione mondiale del medesimo campionato, che sul podio del Campionato Cult GT3.

DINAMIC GT

Fasano Tools sceglie la squadra sportiva Dinamic GT, attiva dal 2019 in campionati monomarca, e ne diventa Sponsor nella stagione sportiva 2023. Nel GT World Challenge Europe, il team ha festeggiato quattro vittorie assolute con la 911 GT3 R. Inoltre è stata attiva anche sulla Nordschleife e ha partecipato come ospite all' ADAC GT Masters nel 2022. La Porsche Verde del team, ha "indossato" il logo Fasano e, con orgoglio, lo ha sfoggiato sui circuiti Internazionali Cult delle competizioni automobilistiche per accendere, a suon di rombo di motori, la fiamma verde della vittoria.



BEFUEL

D'ispirazione per tutti i professionisti del settore della meccanica, della carrozzeria e del mondo automotive, i nostri Partner di Be Fuel Performance lavorano ormai da anni utilizzando i carrelli Made in Italy customizzati e gli utensili Fasano Tools. Non esiste sul web un progetto che sia uguale a loro. Ai ragazzi di Be Fuel modificare e personalizzare non basta quasi più. Le auto "bacciate" dal loro tocco diventano dei veri e propri prototipi da sfoggiare in piste e competizioni prestigiose, per superare ogni volta il limite imposto. Nel 2023 ci hanno stupiti con incredibili makeover di vetture, contest e sfide creative, esplorando nuovi orizzonti del settore Automotive.

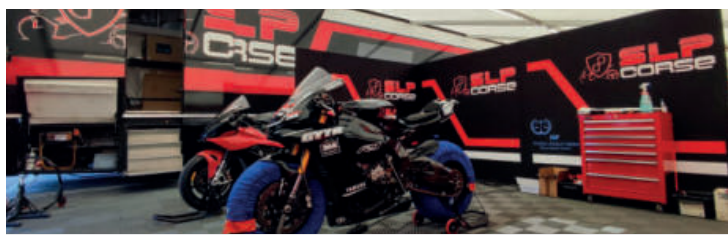

SLP
CORSE

Il nostro partner a due ruote per il 2023 è stato il team sportivo SLP Corse. Impegnata da decenni nelle competizioni motociclistiche, in questa stagione sportiva SLP Corse ha svolto il ruolo di Brand Ambassador Fasano Tools nel Campionato Italiano Velocità, CIV National Trophy e le emozioni che ci ha regalato Alessandro Arcangeli, "il pilota matto della 1000", già Campione 2021 del Trofeo Aprilia RS660, sono state davvero tante. Competiamo per vincere, ma anche per crescere.

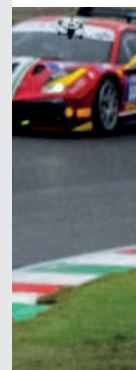



FASANGAS S.r.l.

Viale Grecia 3, lotto 18 Zona Industriale 73100
LECCE (LE) ITALY (+39) 0832.362097/364265
info@fasanotools.com

FASANOTOOLS.COM



VALIDITA': 05-02-2024/02-02-2025



8 053853 745354